

Travelling Merchant: \_\_\_\_\_

# DATASHEET

Standard: DP5X32768011

Plot			The Label
Drew	Audited	Approved	Stamp, please! Thanks!
Date: 2021.12.17			

## Guangdong Dapu Telecom Technology Co.,LTD

Building 5, No.24, Industrial East Road, Songshanhu Park, Dongguan, Guangdong, P.R. China

TEL: 0086-0769-88010888 FAX: 0086-0769-81800098



## 1. Electrical Parameters

MODEL: DP5X32768011							
No.	Parameters	SYM.	Electrical Spec.				Notes
			Min.	Typ.	Max.	Units	
1	Nominal Frequency	FL	32.768			KHz	
2	Oscillation Mode	-	Fundamental			-	
3	Load Capacitance	CL	9			pF	
4	Frequency Tolerance	-	-20		+20	$\times 10^{-6}$	$T_A=25^{\circ}\text{C}$
5	Turning Point		20	25	30	$^{\circ}\text{C}$	
6	ESR			60	80	$\text{K}\Omega$	
7	Parabolic Coefficient	-			-0.04	$\text{ppm}/^{\circ}\text{C}^2$	
8	Operating Temperature	-	-40		+85	$^{\circ}\text{C}$	
9	Storage Temperature Range	-	-40		+85	$^{\circ}\text{C}$	
10	Aging Per Year	-	-3		+3	$\times 10^{-6}$	
11	Drive Level	DL		0.1	0.5	$\mu\text{W}$	
12	Insulation Resistance	-	500	-	-	$\text{M}\Omega$	At DC 100V $\pm$ 15V
13	Shunt Capacitance	C0	0.92	1.15	1.38	pF	



## 2. Mechanical Structure(mm)

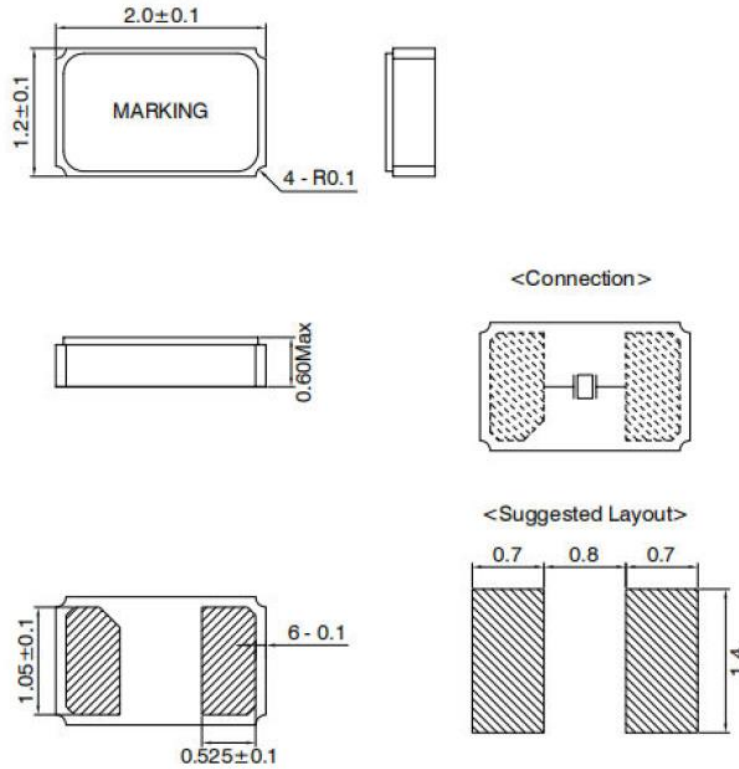

## 3. Marking

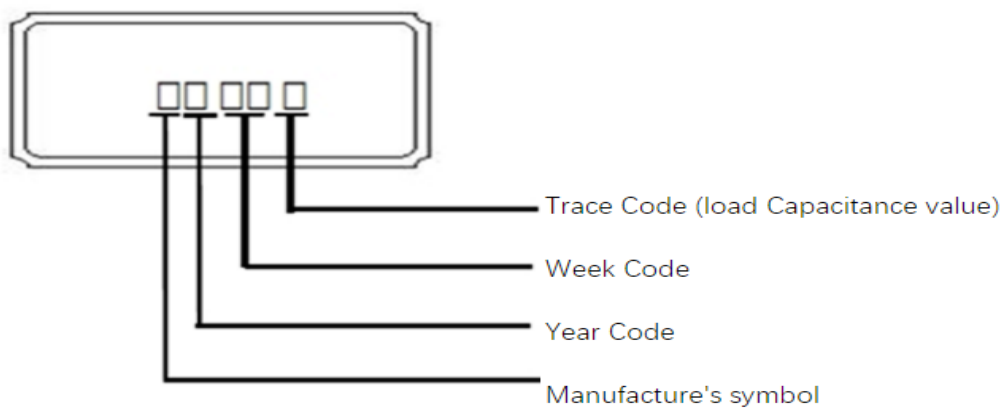

Year : 2021 2022 2023 2024 2025 2026 2027  
Code: 1 2 3 4 5 6 7



#### 4. Package: Tape & Reel (mm)

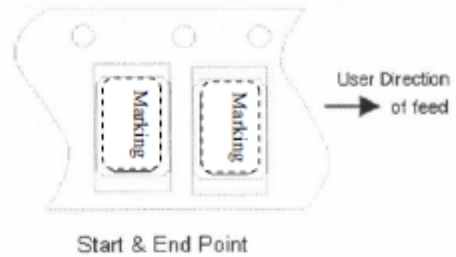
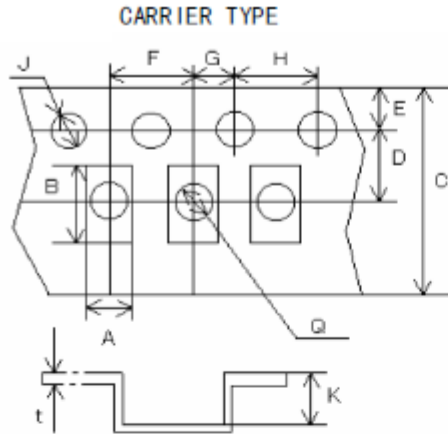

A	B	C	D	E	F	G	H	J	K	t
1.4	2.3	8.0	3.5	1.75	4.0	2.0	4.0	1.5	0.75	0.25

REMARK:

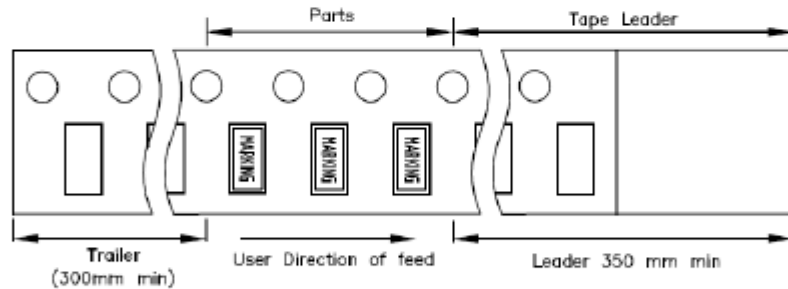

REEL: 3000 PCS/Reel

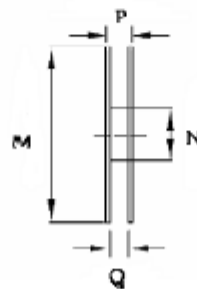
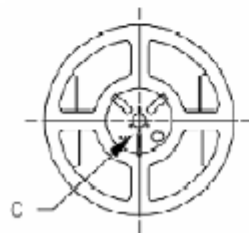

C. ENLARGE

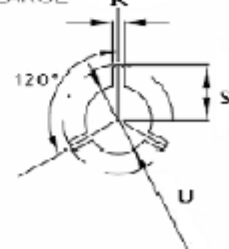

M	N	P	Q	R	S	U
178	60.2	11.5	8.0	2.5	11.0	13.0