

Travelling Merchant: _____

DATASHEET

Standard: **T53-S313-10.00MHz**

P/N: _____

Plot			The Label
Drew	Audited	Approved	Stamp, please! Thanks!
Date: 2021.05.27			

Guangdong Dapu Telecom Technology Co.,Ltd

Building 5, No.24, Industrial East Road, Songshanhu Park, Dongguan, Guangdong, P.R. China

TEL: 0086-0769-88010888 FAX: 0086-0769-81800098



Table of amendment

Version	Revision contents	Prepared by	Revised date
1.0	The first issued	<i>Amway</i>	2014.05.27
1.1	The “Mechanical Structure” changed	<i>Amway</i>	2019.07.09
1.2	The “Frequency Tolerance vs. Operating Temperature Range” “ESD Level” “Moisture Sensitivity Level” “Mechanical Structure” “Package: Tape & Reel” changed	<i>Amway</i>	2020.05.18
1.3	The “Mechanical Structure” changed	<i>Amway</i>	2021.05.27



1. Electrical Parameters

MODEL: T53-S313-10.00MHz						
Item	Description	Parameters			Unit	Test Condition
		Min.	Typ.	Max.		
Output	Frequency	10.00			MHz	
	Output Waveform	HCMOS				
	Output Low Voltage			0.4	V	$V_{cc}=3.3V, O_{load}=15\text{ pF}$
	Output High Voltage	2.4			V	$V_{cc}=3.3V, O_{load}=15\text{ pF}$
	Duty Cycle	45	50	55	%	@50%
	Rise / Fall Time (10%~90%)			8	ns	@25°C
	Load	15			pF	
Frequency Stabilities	Frequency Tolerance vs. Operating Temperature Range	-0.14		+0.14	$\times 10^{-6}$	T_A varied from -40°C to 85°C, measurement referenced to frequency observed with $f_{ref}=(f_{max}+f_{min})/2, V_{cc}=3.3V, V_c=1.5V, O_{load}=15\text{ pF}$, temperature variable speed less than 2°C per minute.
	Nominal Frequency Tolerance	-0.5		+0.5	$\times 10^{-6}$	Measurement referenced to frequency observed with $T_A=25^\circ\text{C}, V_{cc}=3.3V, V_c=1.5V$ within 30 days after ex-works.
	Frequency Tolerance vs. Supply Voltage	-0.1		+0.1	$\times 10^{-6}$	measurement referenced to frequency observed $T_A=25^\circ\text{C}, V_{cc}$ varied from 3.13V to 3.47V, $V_c=1.5V$ and $O_{Load}=15\text{ pF}$.
	Frequency Tolerance vs. Load	-0.2		+0.2	$\times 10^{-6}$	5% load change measurement referenced to frequency observed with $T_A=25^\circ\text{C}, V_{cc}=3.3V, V_c=1.5V, O_{Load}=15\text{ pF}$
	Aging Tolerance Per Day	-0.02		+0.02	$\times 10^{-6}$	$T_A=25^\circ\text{C}, V_{cc}=3.3V, V_c=1.5V$ and after 1h of operation.
	Aging Tolerance 1 Year	-1		+1	$\times 10^{-6}$	
Power Supply	Current Consumption			10	mA	@25°C, $V_{cc}=3.3V, V_c=1.5V, O_{load}=15\text{ pF}$.
	Supply Voltage	3.13	3.3	3.47	V	



Voltage Control Characteristics	Frequency Tuning Range	-15		-10	$\times 10^{-6}$	$V_c=0V$. measurement referenced to $V_c=1.5V$.
		-0.5		+0.5	$\times 10^{-6}$	$V_c=1.5V$. measurement referenced to Exactly 10.00MHz.
		+10		+15	$\times 10^{-6}$	$V_c=3.0V$. measurement referenced to $V_c=1.5V$.
	Linearity			10	%	
	Slope	Positive				
	Input Impedance	100				K Ω
Phase Noise	Phase Noise @25°C		-90	-85	dBc/Hz	10Hz
			-115	-110		100Hz
			-135	-130		1KHz
			-145	-140		10KHz
			-148	-143		100KHz
			-150	-145		1MHz
Environmental Conditions	Operable Temperature	-40		+85	°C	
	Storage Temperature	-55		+105	°C	
	ESD Level	Human Body Model, class2: 2000V to 4000V; ANSI/ESDA/JEDEC JS-001-2010.				
		Machine Model, class B: 200V to 400V; JEDEC JESD22-A115C.				
	Moisture Sensitivity Level	Level 2.				
	Vibration	Test Condition: 0.75mm ;acceleration:10g;10Hz~2000Hz, one cycle per 30 min, test 2 hour. (3 times for each 3 directions X ,Y , Z) .IEC 68-2-06 Test Fc.				
Shock	100g; 6ms; half sine wave (3 times for each 3 directions X ,Y , Z),IEC 68-2-27 Test Ea/Severity 50A.					



2. Mechanical Structure(mm)

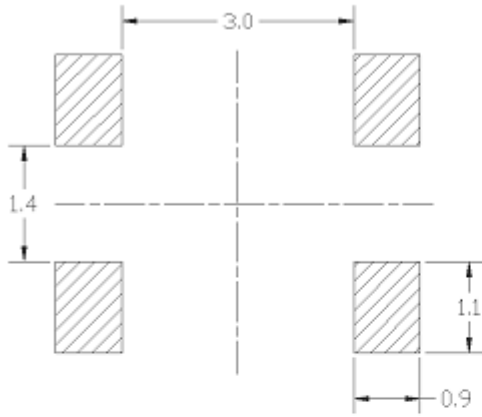

Solder pad layout

Bottom view

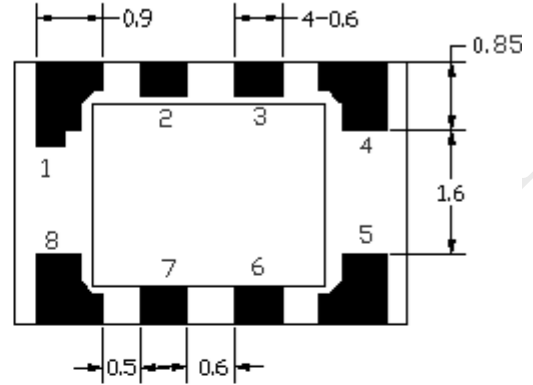

Side view

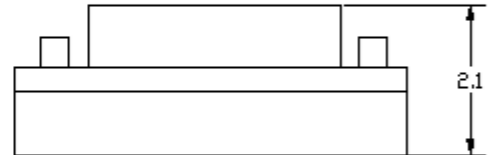

PIN FUNCTION

PIN	NOTATION	FUNCTION
1	VC	Control Voltage
2,3	NC	Not Connect
4	GND	GND
5	OUTPUT	RF Output
6,7	NC	Not Connect
8	VCC	Supply Voltage

Top view

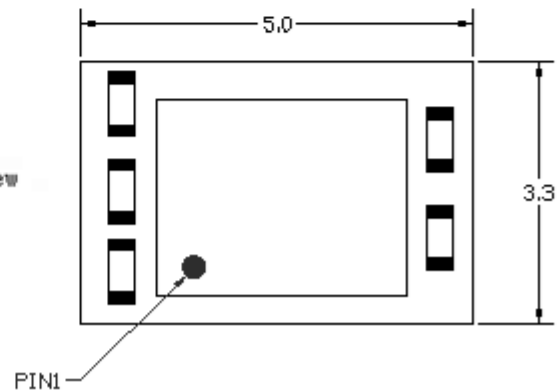

Note1: Tolerance $\pm 0.2\text{mm}$ without mark

Note2: Referential Weight 0.05g

Note3: NC is not connect



3. Test circuit

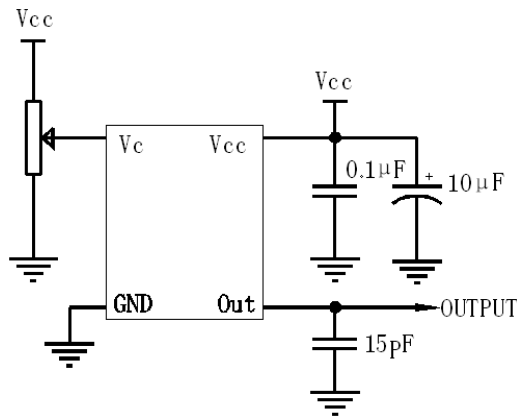

4. Reflow Soldering Curve (RoHS)

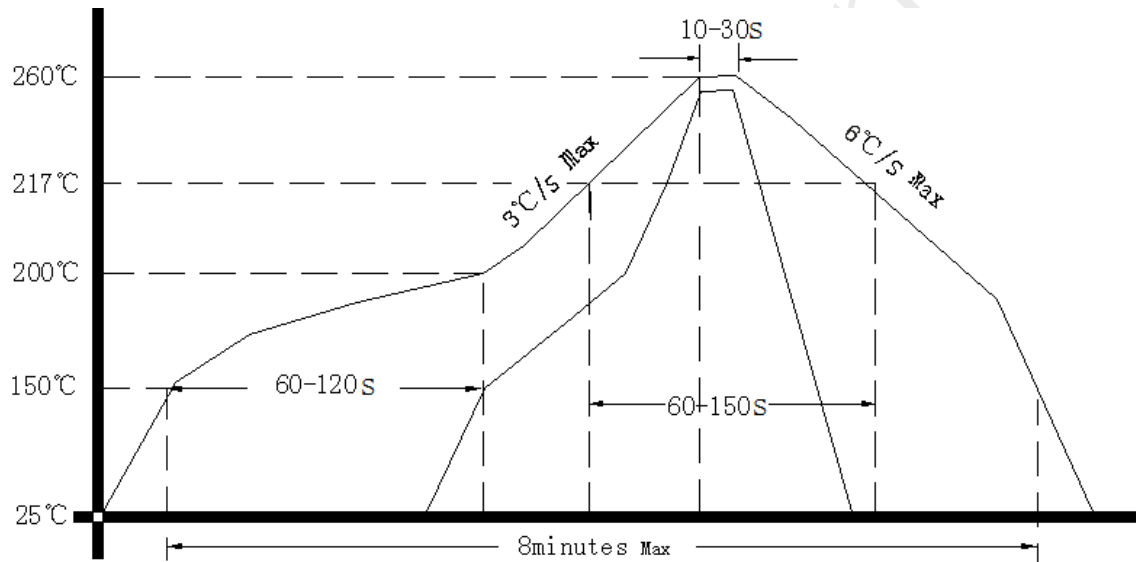

5. Package: Tape & Reel (mm)

