

Customer Code : _____

DATASHEET

DAPU P/N: **O22S-L119-10.00MHz**

Customer P/N: _____

DAPU			Customer Approval
Drew	Audited	Approved	Stamp, please! Thanks!
Date: 2020.07.10			

Guangdong Dapu Telecom Technology Co.,Ltd

Bldg13-16,.N.Ind.Zone,SSL Industry Park, Dongguan City, Guangdong Province, China

TEL: 0086-0769-88010888 FAX: 0086-0769-81800098



1. Electrical Parameters

MODEL: O22S-L119-10.00MHz						
Item	Description	Parameters			Unit	Test Condition
		Min.	Typ.	Max.		
Output	Frequency	10.00			MHz	
	Output Waveform	LVTTTL				
	Overshoot			10	%	
	Output Low Voltage			0.4	V	V _{cc} =3.3V, load=15pF
	Output High Voltage	2.4			V	V _{cc} =3.3V, load=15pF
	Duty Cycle	45	50	55	%	@50%
	Rise / Fall Time (10%~90%)			5	ns	
	Load	13.5	15	16.5	pF	
	Start time			0.5	s	
	Spurious			-70	dBc	
Frequency Stabilities	Frequency Tolerance vs. Operating Temperature Range	-0.5		+0.5	$\times 10^{-9}$	TA varied from -40°C to 85°C, measurement referenced to frequency observed with $f_{ref}=(f_{max}+f_{min})/2$, V _{cc} =3.3V, load=15pF, temperature variable speed less than 2°C per minute.
	Initial Frequency Tolerance	-2.0		+2.0	$\times 10^{-6}$	Measurement referenced to frequency observed with TA=25°C, V _{cc} =3.3V, and after 15 minutes of operation, within 30 days after ex-works.
	Frequency Tolerance vs. Supply Voltage	-0.2		+0.2	$\times 10^{-9}$	measurement referenced to frequency observed TA=25°C, V _{cc} varied from 3.13V to 3.47V, and Load=15pF.
	Frequency Tolerance vs. Load	-0.2		+0.2	$\times 10^{-9}$	10% load change measurement referenced to frequency observed with TA=25°C, V _{cc} =3.3V, and Load=15pF.
	Micro jump	-0.1		+0.1	$\times 10^{-9}$	Continuous testing for 48 hours, temperature Fluctuations<3°C, one sampling/10s.
	Reflow shift	-0.2		+0.2	$\times 10^{-6}$	After 24 hour recovery at 25°C 2 times reflow
	Retrace	-0.01		+0.01	$\times 10^{-6}$	After 24 hour off at 25°C 15min power on
Short-Term Stability Allan Variance			0.01	$\times 10^{-9}$	Temperature stability, no EMI\EMC or other interference, test after power for 1hour ref. to 25°C; 1s.	



	Aging Tolerance Per Day	-0.5		+0.5	$\times 10^{-9}$	Vcc,TA constant measurement referenced to frequency observed with TA=25°C,Vcc=3.3V, and after 30 days of operation.
	Aging Tolerance 1 Year	-0.05		+0.05	$\times 10^{-6}$	
Power Supply	Supply Voltage	3.13	3.3	3.47	V	
	Steady Consumption			400	mA	@25°C
	Warm up current			1200	mA	
	Warm-Up Time			8	minutes	@25°C within $\pm 0.01 \times 10^{-6}$ of final frequency with reference after 1 hour on.
Phase Noise	Phase Noise		-100	-90	dBc/Hz	1Hz
			-125	-120		10Hz
			-145	-140		100Hz
			-155	-150		1KHz
			-157	-155		10KHz
			-157	-155		100KHz
			-160	-155		1MHz
Jitter	Jitter			0.5	ps	RMS (12kHz ~5MHz)
Acceleration sensitivity				4	ppb/g	
Environmental Conditions	Operating environmental condition	-40		+85	°C	
	Operable Temperature range	-40		+90	°C	
	Storage Temperature	-40		+90	°C	
	Relative Humidity	5		85	%	
	ESD Level	Human Body Model, class2: 2000V to 4000V; ANSI/ESDA/JEDEC JS-001-2010.				
		Machine Model, class B: 200V to 400V; JEDEC JESD22-A115C.				
	Moisture Sensitivity Level	Level 3.				
	Vibration	Test Condition: 0.75mm ;acceleration:10g;10Hz~500Hz, one cycle per 30 min, test 2 hour. (3 times for each 3 directions X , Y , Z), IEC 68-2-06 Test Fc.				
Shock	50g; 11ms; half sine wave (3 times for each 3 directions X, Y, Z), IEC 68-2-27 Test Ea/Severity 50A.					
Full Package Storage	Relative humidity (%)	20%~70%				
	Temperature (°C)	-10~35°C				



2. Mechanical Structure (mm)

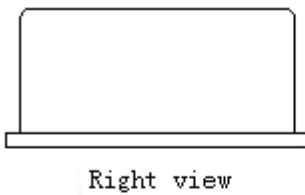
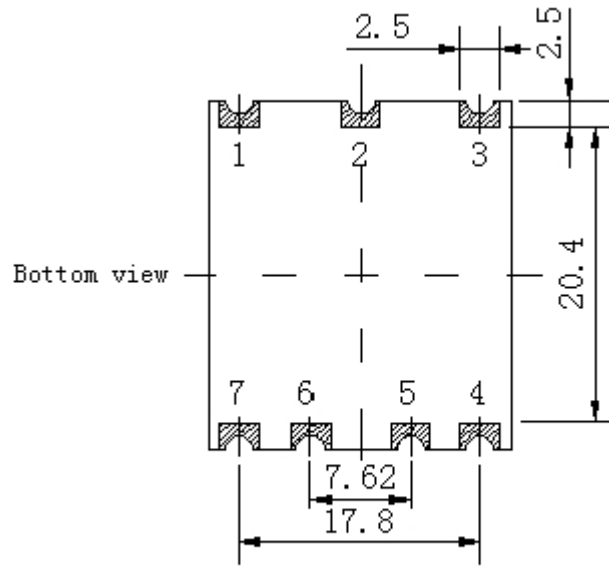
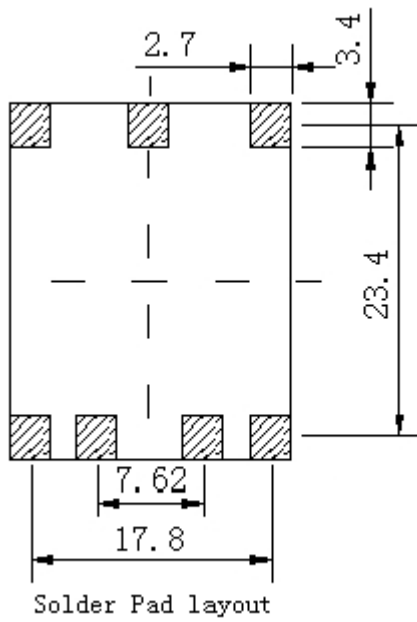

PIN FUNCTION

PIN	NOTATION	FUNCTION
1	NC	Not Connect
2	NC	Not Connect
3	VCC	Supply Voltage
4	OUTPUT	RF Output
5,6	NC	Not Connect
7	GND	GND

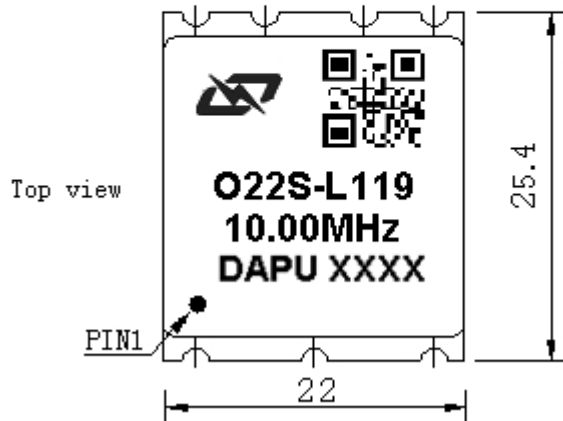

- Note1:** Tolerance $\pm 0.2\text{mm}$ without mark
- Note2:** The first two xx representative: week
After two xx representative: year
- Note3:** Referential weight 8.0g
- Note4:** NC is not connect



4. Test Circuit

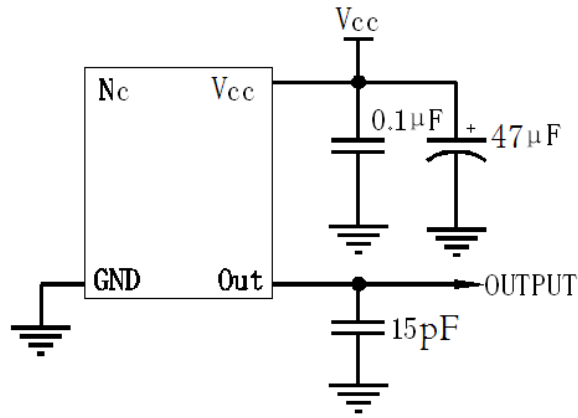

5. Reflow Soldering Curve (RoHS)

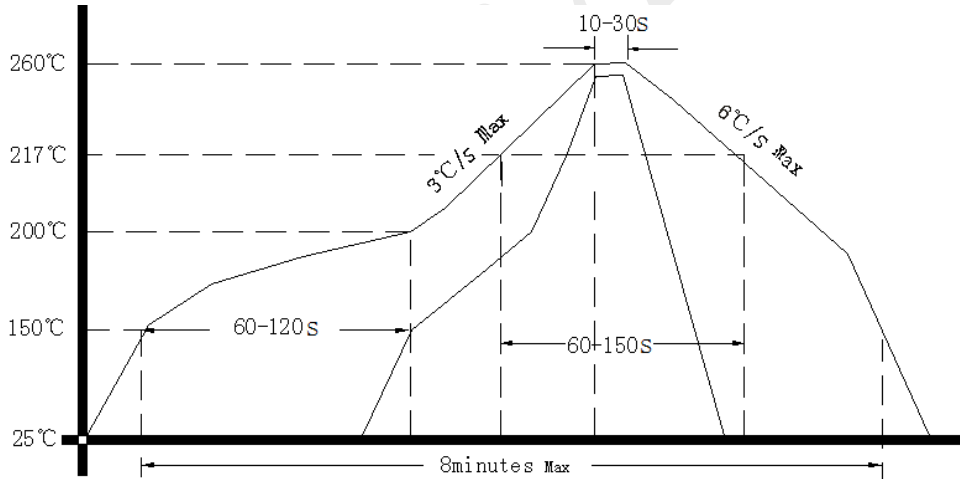



6. Current vs. Temperature Curve

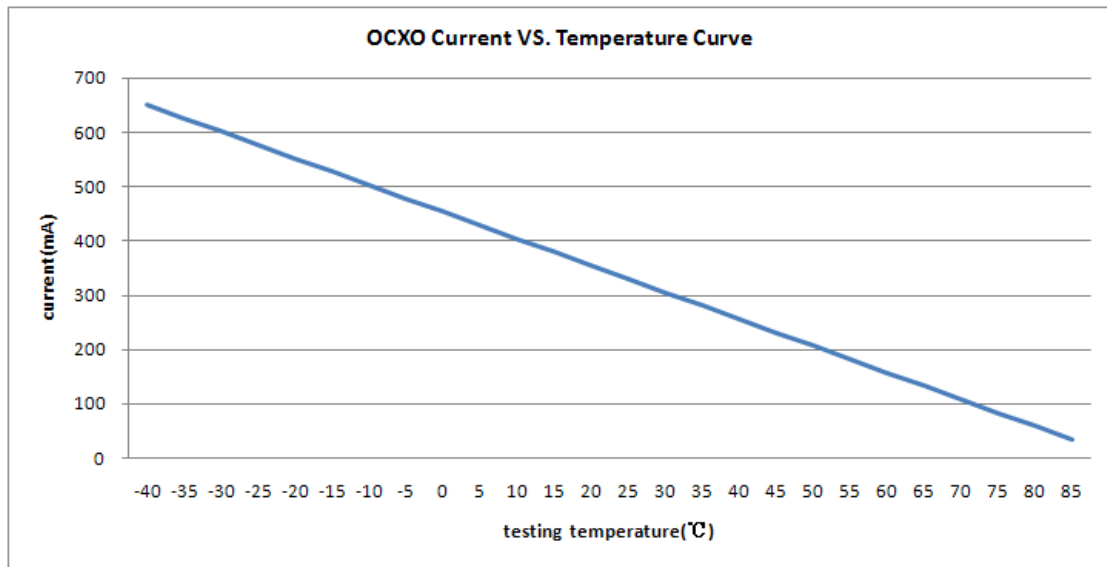

7. Package: Tape & Reel (mm)

