

Travelling Merchant: _____

DATASHEET

Standard: **O11F-A319-10.00MHz**

P/N: _____

Plot			The Label
Drew	Audited	Approved	Stamp, please! Thanks!
Date: 2020.03.25			

Guangdong Dapu Telecom Technology Co.,Ltd

Bldg13-16,.N.Ind.Zone,SSL Industry Park, Dongguan City, Guangdong Province, China

TEL: 0086-0769-88010888 FAX: 0086-0769-81800098



Table of amendment

Version	Revision contents	Prepared by	Revised date
1.0	The first issued	<i>Amway</i>	2018.12.07
1.1	“Mechanical Structure” and “Power Supply ” changed	<i>Amway</i>	2018.12.13
1.2	“Shock” changed	<i>Amway</i>	2018.12.20
1.3	“Phase Noise” “Warm up current” changed	<i>Amway</i>	2019.03.26
1.4	Remove “In a 24h period at constant temperature”, Add “Aging Tolerance Per day”	<i>Amway</i>	2020.01.09
1.5	The “ESD Level” “Package: Tape & Reel” changed	<i>Amway</i>	2020.03.25



1. Electrical Parameters

MODEL: O11F-A319-10.00MHz						
Item	Description	Parameters			Unit	Test Condition
		Min.	Typ.	Max.		
Output	Frequency	10.00			MHz	
	Output Waveform	HCMOS				
	Output Low Voltage			0.3	V	$V_{cc}=3.3V, O_{load}=15\text{ pF}$
	Output High Voltage	2.4			V	$V_{cc}=3.3V, O_{load}=15\text{ pF}$
	Duty Cycle	45		55	%	@50%
	Rise / Fall Time (10%~90%)			5	ns	@25°C
	Load	15			pF	
Frequency Stabilities	Frequency Tolerance vs. Operating Temperature Range	-0.03		+0.03	$\times 10^{-6}$	T_A varied from -40°C to 95°C, measurement referenced to frequency observed with $f_{ref}=(f_{max}+f_{min})/2, V_{cc}=3.3V, O_{load}=15\text{ pF}$, temperature variable speed less than 2°C per minute.
	Initial Frequency Tolerance	-0.5		+0.5	$\times 10^{-6}$	Measurement referenced to frequency observed with $T_A=25^\circ\text{C}, V_{cc}=3.3V$ within 30 days after ex-works.
	Frequency Tolerance vs. Supply Voltage	-0.01		+0.01	$\times 10^{-6}$	measurement referenced to frequency observed $T_A=25^\circ\text{C}, V_{cc}$ varied from 3.13V to 3.47V, and $O_{Load}=15\text{ pF}$.
	Frequency Tolerance vs. Load	-0.01		+0.01	$\times 10^{-6}$	5% load change measurement referenced to frequency observed with $T_A=25^\circ\text{C}, V_{cc}=3.3V, O_{Load}=15\text{ pF}$.
	Aging Tolerance Per day	-2		+2	$\times 10^{-9}$	$T_A=25^\circ\text{C}, V_{cc}=3.3V$, and after 30 days of operation.
	Aging Tolerance 1 Year	-0.8		+0.8	$\times 10^{-6}$	
	Aging Tolerance 10 Year	-2.5		+2.5	$\times 10^{-6}$	



Power Supply	Steady Consumption			200	mA	@25°C
	Warm up current			800	mA	
	Supply Voltage	3.13	3.3	3.47	V	
Phase Noise	Phase Noise		-70	-60	dBc/Hz	1Hz
			-118	-108		10Hz
			-142	-132		100Hz
			-153	-148		1KHz
			-158	-153		10KHz
			-158	-153		100KHz
			-158	-153		1MHz
Environmental Conditions	Operable Temperature	-40		+95	°C	
	Storage Temperature	-40		+95	°C	
	ESD Level	Human Body Model, class2: 2000V to 4000V; ANSI/ESDA/JEDEC JS-001-2010.				
		Machine Model, class B: 200V to 400V; JEDEC JESD22-A115C.				
	Moisture Sensitivity Level	Level 2				
	Vibration	Test Condition: 0.75mm ;acceleration:10g;10Hz~500Hz, one cycle per 30 min, test 2 hour. (3 times for each 3 directions X , Y , Z), IEC 68-2-06 Test Fc.				
Shock	50g; 11ms; half sine wave (3 times for each 3 directions X, Y, Z), IEC 68-2-27 Test Ea/Severity 50A.					



2. Mechanical Structure(mm)

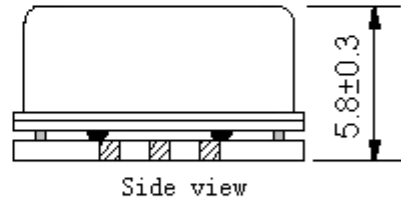
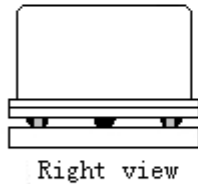
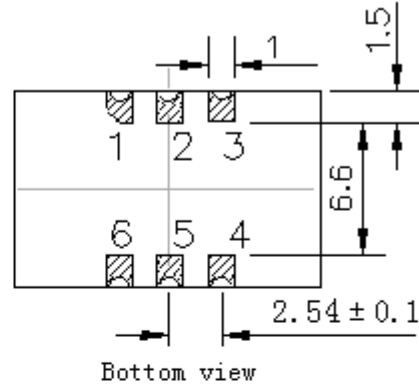
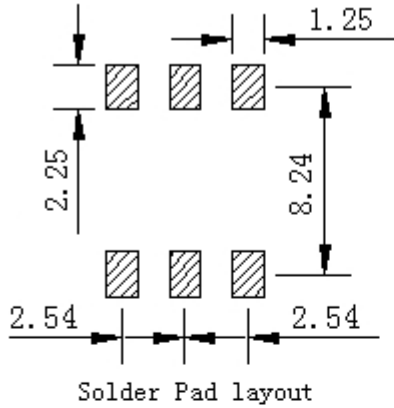

PIN FUNCTION

PIN	NOTATION	FUNCTION
1	NC	Not Connect
2,5	NC	Not Connect
3	GND	GND
4	OUTPUT	RF Output
6	VCC	Supply Voltage

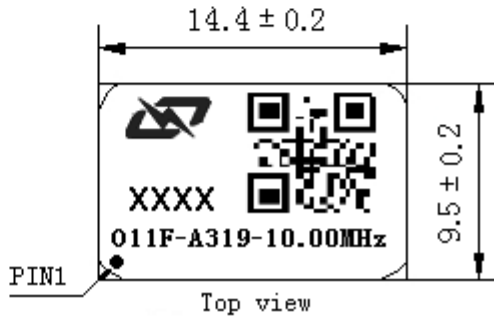

Note1: Tolerance $\pm 0.2\text{mm}$ without mark

Note2: The first two xx representative: week
After two xx representative: year

Note3: Referential weight 2.2g

Note4: NC is not connect

Note5: Passing through reflow upside down is not supported



3. Test circuit

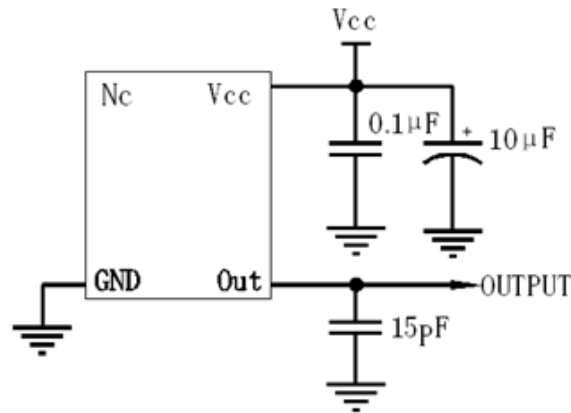

4. Reflow Soldering Curve (RoHS)

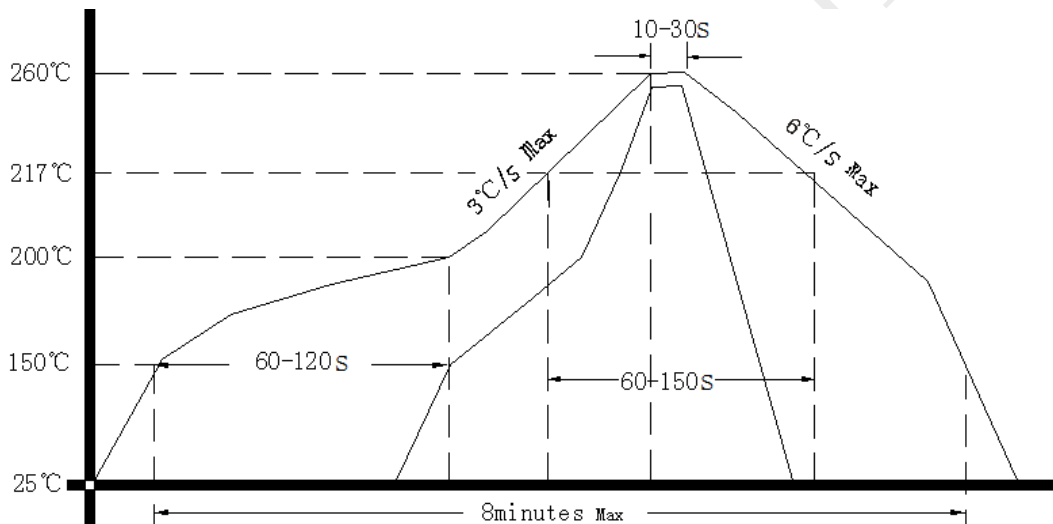

5. Package: Tape & Reel (mm)

