

Customer Code : \_\_\_\_\_

# DATASHEET

DAPU P/N:     **T11A-B426-100.00MHz**    

Customer P/N: \_\_\_\_\_

DAPU			Customer Approval
Drew	Audited	Approved	Stamp, please! Thanks!
Date: 2020.06.23			

## Guangdong Dapu Telecom Technology Co.,Ltd

Bldg13-16,.N.Ind.Zone,SSL Industry Park, Dongguan City, Guangdong Province, China

TEL: 0086-0769-88010888 FAX: 0086-0769-81800098





## 1. Electrical Parameters

MODEL: T11A-B426-100.00MHz						
Item	Description	Parameters			Unit	Test Condition
		Min.	Typ.	Max.		
Output	Frequency	100.00			MHz	
	Output Waveform	Sine Wave				
	Level	5			dBm	
	Harmonics Suppression			-30	dBc	
	Spurious Suppression			-60	dBc	
	Load	50			$\Omega$	
Frequency Stabilities	Frequency Tolerance vs. Operating Temperature Range	-0.1		+0.1	$\times 10^{-6}$	$T_A$ varied from $-40^\circ\text{C}$ to $85^\circ\text{C}$ , measurement referenced to frequency observed with $f_{\text{ref}}=(f_{\text{max}}+f_{\text{min}})/2$ , $V_{\text{cc}}=5.0\text{V}$ , $V_c=2.5\text{V}$ , $O_{\text{load}}=50\Omega$ , temperature variable speed less than $2^\circ\text{C}$ per minute.
	Initial Frequency Tolerance	-1		+1	$\times 10^{-6}$	Measurement referenced to frequency observed with $T_A=25^\circ\text{C}$ , $V_{\text{cc}}=5.0\text{V}$ , $V_c=2.5\text{V}$ within 30 days after ex-works.
	Frequency Tolerance vs. Supply Voltage	-0.2		+0.2	$\times 10^{-6}$	measurement referenced to frequency observed $T_A=25^\circ\text{C}$ , $V_{\text{cc}}$ varied from 4.75V to 5.25V, $V_c=2.5\text{V}$ and $O_{\text{Load}}=50\Omega$ .
	Frequency Tolerance vs. Load	-0.2		+0.2	$\times 10^{-6}$	5% load change measurement referenced to frequency observed with $T_A=25^\circ\text{C}$ , $V_{\text{cc}}=5.0\text{V}$ , $V_c=2.5\text{V}$ , $O_{\text{Load}}=50\Omega$ .
	Aging Tolerance Per Day	-0.02		+0.02	$\times 10^{-6}$	$T_A=25^\circ\text{C}$ , $V_{\text{cc}}=5.0\text{V}$ , $V_c=2.5\text{V}$ and after 1h of operation.
	Aging Tolerance 1 Year	-1		+1	$\times 10^{-6}$	
Power Supply	Current Consumption			30	mA	@ $25^\circ\text{C}$ , $V_{\text{cc}}=5.0\text{V}$ , $V_c=2.5\text{V}$ , $O_{\text{load}}=50\Omega$ .
	Supply Voltage	4.75	5.0	5.25	V	



Voltage Control Characteristics	Frequency Tuning Range	-15		-10	$\times 10^{-6}$	$V_c=0V$ . measurement referenced to $V_c=2.5V$
		-1		+1	$\times 10^{-6}$	$V_c=2.5V$ . measurement referenced to exactly 100.00MHz
		+10		+15	$\times 10^{-6}$	$V_c=5.0V$ . measurement referenced to $V_c=2.5V$
	Linearity			10	%	
	Slope	Positive				
	Input Impedance	100			K $\Omega$	
Phase Noise	Phase Noise		-120	-115	dBc/Hz	1KHz
Environmental Conditions	Operable Temperature	-40		+85	$^{\circ}C$	
	Storage Temperature	-55		+105	$^{\circ}C$	
	ESD Level	Human Body Model,class2: 2000V to 4000V; ANSI/ESDA/JEDEC JS-001-2010.				
		Machine Model, class B: 200V to 400V; JEDEC JESD22-A115C.				
	Moisture Sensitivity Level	Not humidity sensitive.				
	Vibration	Test Condition: 0.75mm ;acceleration:10g;10Hz~2000Hz, one cycle per 30 min, test 2 hour. (3 times for each 3 directions X ,Y , Z) .IEC 68-2-06 Test Fc.				
Shock	100g; 6ms; half sine wave (3 times for each 3 directions X ,Y , Z ),IEC 68-2-27 Test Ea/Severity 50A.					
Full Package Storage	Relative humidity (%)	20%~70%				
	Temperature ( $^{\circ}C$ )	-10~35 $^{\circ}C$				



## 2. Mechanical Structure(mm)

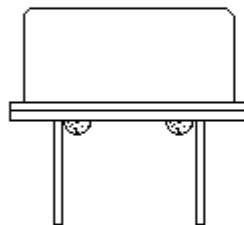
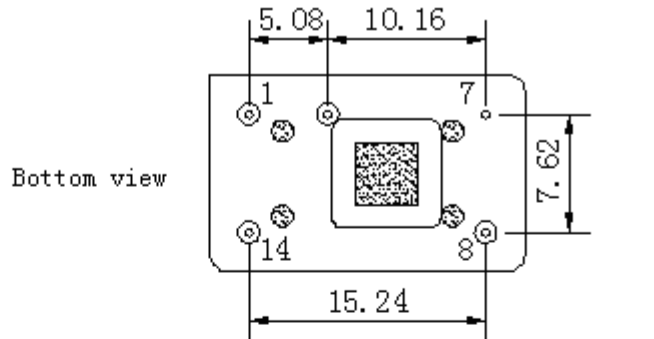

Right view

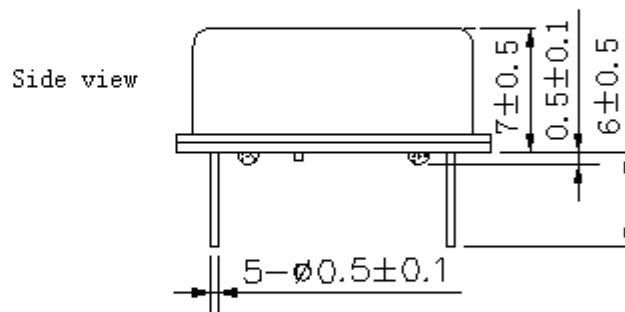

### PIN FUNCTION

PIN	NOTATION	FUNCTION
1	VC	Control Voltage
7	GND	GND
8	OUTPUT	RF Output
14	VCC	Supply Voltage

Top view

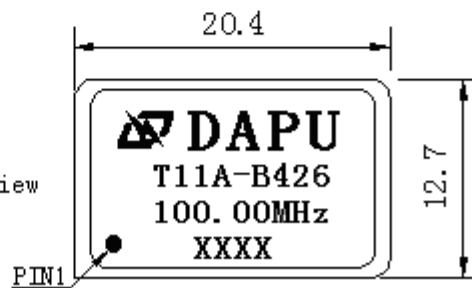

- Note1:** Tolerance  $\pm 0.20\text{mm}$  without mark
- Note2:** The first two xx representative: week  
After two xx representative: year
- Note3:** Referential weight 4.2g



### 3. Test circuit

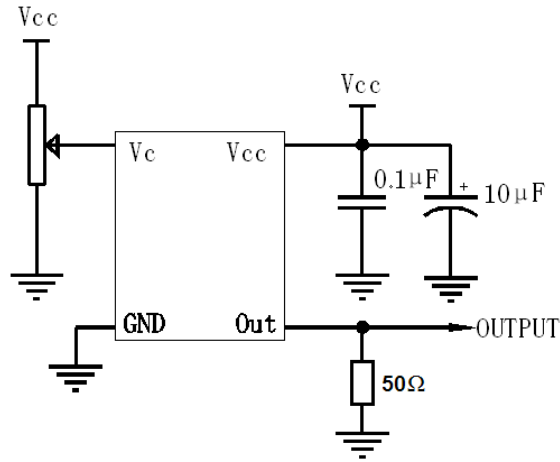

### 4. Reflow Soldering Curve (RoHS)

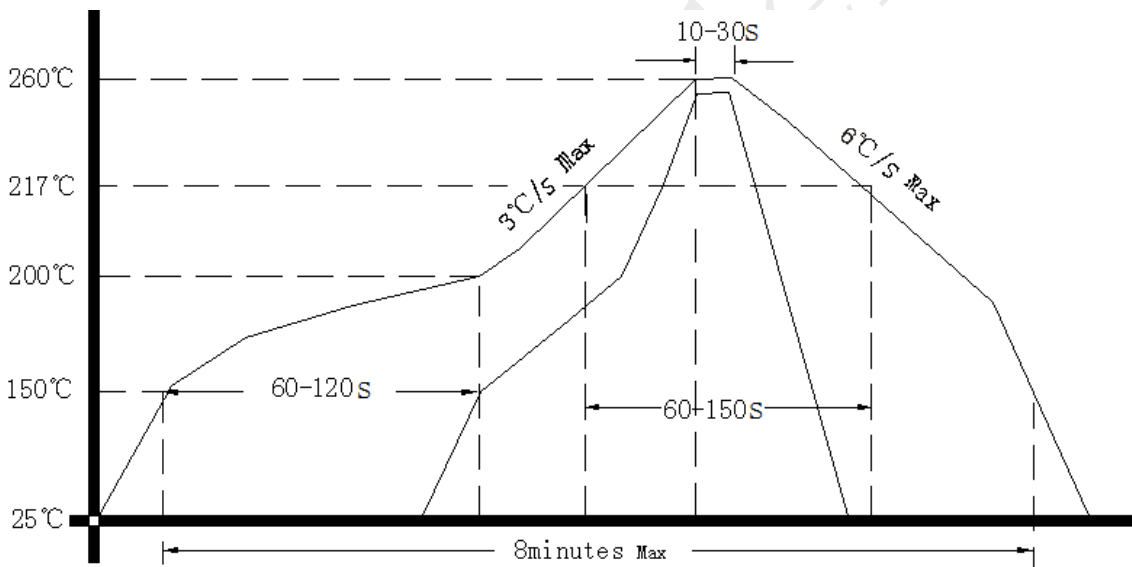

### 5. Package: PVC Tube,10pcs (mm)

