

Travelling Merchant: \_\_\_\_\_

# DATASHEET

Standard:           **O11F-X411-100.00MHz**          

P/N: \_\_\_\_\_

Plot			The Label
Drew	Audited	Approved	Stamp, please! Thanks!
Date: 2019.06.14			

## Guangdong Dapu Telecom Technology Co.,Ltd

Bldg13-16,.N.Ind.Zone,SSL Industry Park, Dongguan City, Guangdong Province, China

TEL: 0086-0769-88010888    FAX: 0086-0769-81800098





## 1. Electrical Parameters

MODEL: O11F-X411-100.00MHz						
Item	Description	Parameters			Unit	Test Condition
		Min.	Typ.	Max.		
Output	Frequency	100.00			MHz	
	Output Waveform	Sine wave				
	Level	6			dBm	
	Load	50			$\Omega$	
	Harmonics Suppression			-30	dBc	
	Spurious Suppression			-60	dBc	
Frequency Stabilities	Frequency Tolerance vs. Operating Temperature Range	-0.05		+0.05	$\times 10^{-6}$	$T_A$ varied from $-40^\circ\text{C}$ to $85^\circ\text{C}$ , measurement referenced to frequency observed with $f_{\text{ref}}=(f_{\text{max}}+f_{\text{min}})/2$ , $V_{\text{cc}}=3.3\text{V}$ , $V_c=1.65\text{V}$ , $O_{\text{load}}=50\Omega$ , temperature variable speed less than $2^\circ\text{C}$ per minute.
	Initial Frequency Tolerance	-0.5		+0.5	$\times 10^{-6}$	Measurement referenced to frequency observed with $T_A=25^\circ\text{C}$ , $V_{\text{cc}}=3.3\text{V}$ , $V_c=1.65\text{V}$ and after 15 minutes of operation, within 30 days after ex-works.
	Frequency Tolerance vs. supply voltage	-0.05		+0.05	$\times 10^{-6}$	measurement referenced to frequency observed $T_A=25^\circ\text{C}$ , $V_{\text{cc}}$ varied from 3.13V to 3.47V, $V_c=1.65\text{V}$ , $O_{\text{load}}=50\Omega$ .
	Frequency Tolerance vs. Load	-0.05		+0.05	$\times 10^{-6}$	5% Load Change Measurement referenced to frequency observed with $T_A=25^\circ\text{C}$ , $V_{\text{cc}}=3.3\text{V}$ , $V_c=1.65\text{V}$ , $O_{\text{load}}=50\Omega$ .
	Short Term Stability			0.1	$\times 10^{-9}$	Temperature stability, no EMI\EMC or other interference, test after power for 1hour ref. to $25^\circ\text{C}$ ; 1s, using PN9000 equipment.
	Aging Tolerance per day	-0.02		+0.02	$\times 10^{-6}$	$V_{\text{cc}}, V_c, T_A$ constant Measurement referenced to frequency observed with $T_A=25^\circ\text{C}$ , $V_{\text{cc}}=3.3\text{V}$ , $V_c=1.65\text{V}$ , $O_{\text{load}}=50\Omega$ and after 30 days of operation.
	Aging Tolerance 1Year	-1.0		+1.0	$\times 10^{-6}$	



Power Supply	Supply Voltage	3.13	3.3	3.47	V	
	Current Consumption			300	mA	@25°C
	Current Consumption during warm up			600	mA	
	Warm-Up Time			5	min	@25°C within $\pm 0.1 \times 10^{-6}$ of final frequency with reference after 1 hour on.
Voltage Control Characteristics	Frequency Tuning Range	-8		-3	$\times 10^{-6}$	$V_c=0V$ . measurement referenced to $V_c=1.65V$ .
		-0.5		+0.5	$\times 10^{-6}$	$V_c=1.65V$ . measurement referenced to exactly 100.00MHz.
		+3		+8	$\times 10^{-6}$	$V_c=3.3V$ . measurement referenced to $V_c=1.65V$ .
	Linearity			10	%	
	Slope	Positive				
	Input Impedance	100			K $\Omega$	
Phase Noise	Phase Noise		-85	-75	dBc/Hz	10Hz
			-120	-110		100Hz
			-140	-135		1KHz
			-150	-145		10KHz
			-150	-145		100KHz
			-150	-145		1MHz
			-150	-145		
Environmental Conditions	Operable Temperature	-40		+85	°C	
	Storage Temperature	-55		+105	°C	
	ESD Level	Human Body Model, class2: 2000V to 4000V; ANSI/ESDA/JEDEC JS-001-2010.				
		Machine Model, class B: 200V to 400V; ANSI/ESDA/JEDEC JS-001-2010.				
	Moisture Sensitivity Level	Level 2.				
	Vibration	Test Condition: 0.75mm ;acceleration:10g;10Hz~500Hz, one cycle per 30 min, test 2 hour. (3 times for each 3 directions X ,Y , Z), IEC 68-2-06 Test Fc.				
Shock	50g; 11ms; half sine wave (3 times for each 3 directions X ,Y , Z ),IEC 68-2-27 Test Ea/Severity 50A.					
Full Package Storage	Relative humidity (%)	20% ~70%				
	Temperature (°C)	-10~35°C				



## 2. Mechanical Structure (mm)

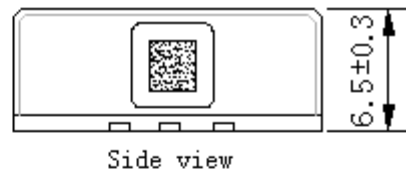
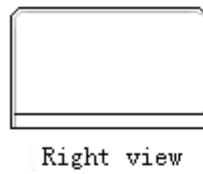
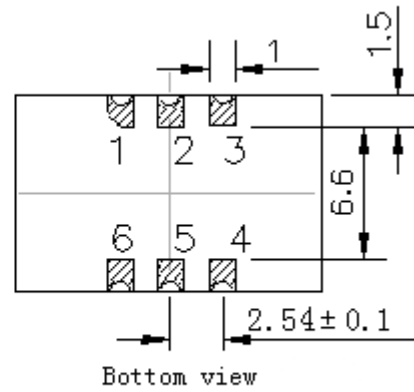
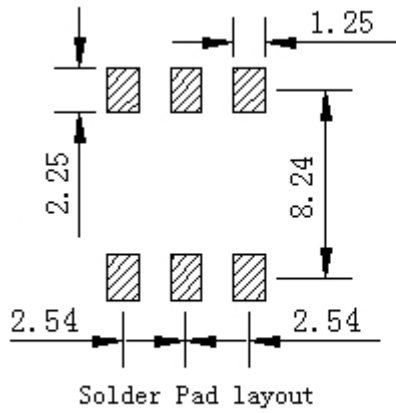

### PIN FUNCTION

PIN	NOTATION	FUNCTION
1	VC	Control Voltage
2,5	NC	Not Connect
3	GND	GND
4	OUTPUT	RF Output
6	VCC	Supply Voltage

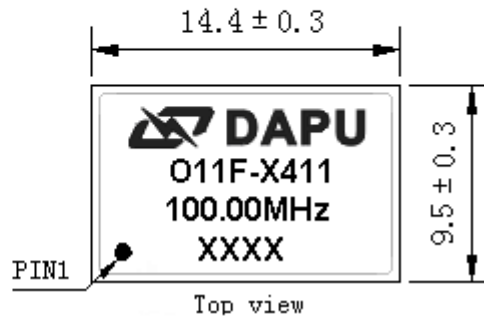

- Note1:** Tolerance  $\pm 0.2\text{mm}$  without mark
- Note2:** The first two xx representative: week  
After two xx representative: year
- Note3:** Referential weight 2.2g
- Note4:** NC is not connect



### 3. Test Circuit

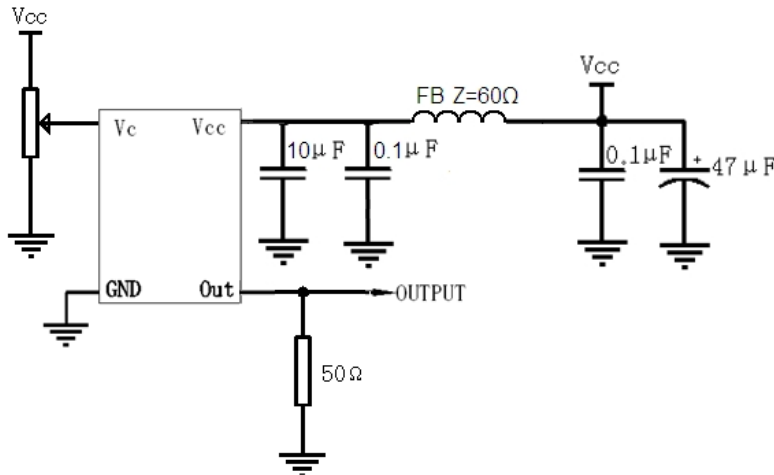

### 4. Reflow Soldering Curve (RoHS)

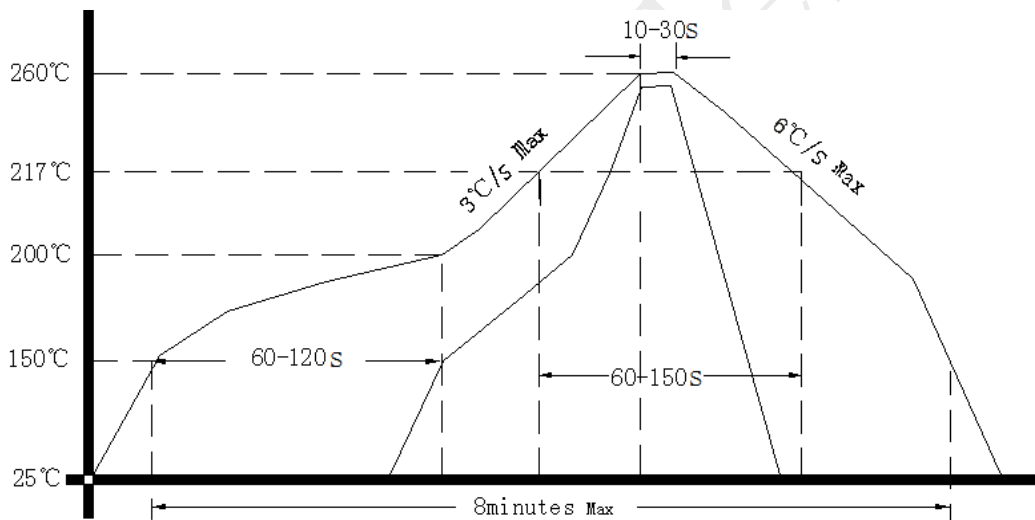

### 5. Package: Tape & Reel (mm)

