

Travelling Merchant: _____

DATASHEET

Standard: **T936-P429-100.00MHz**

P/N: _____

Plot			The Label
Drew	Audited	Approved	Stamp, please! Thanks!
Date: 2018.06.04			

Guangdong Dapu Telecom Technology Co.,Ltd

Bldg13-16,.N.Ind.Zone,SSL Industry Park, Dongguan City, Guangdong Province, China

TEL: 0086-0769-88010888 FAX: 0086-0769-81800098



1. Electrical Parameters

MODEL: T936-P429-100.00MHz						
Item	Description	Parameters			Unit	Test Condition
		Min.	Typ.	Max.		
Output	Frequency	100.00			MHz	
	Output Waveform	Sine Wave				
	Level	4	6	8	dBm	
	Harmonics Suppression		-30		dBc	
	Spurious Suppression		-75		dBc	
	Load	50			Ω	
Frequency Stabilities	Frequency Tolerance vs. Operating Temperature Range	-0.5		+0.5	$\times 10^{-6}$	T_A varied from -20°C to 70°C , measurement referenced to frequency observed with $T_A=25^{\circ}\text{C}$, $V_{cc}=5.0\text{V}$, $O_{load}=50\Omega$, temperature variable speed less than 2°C per minute.
	Initial Frequency Tolerance	-1		+1	$\times 10^{-6}$	Measurement referenced to frequency observed with $T_A=25^{\circ}\text{C}$, $V_{cc}=5.0\text{V}$, within 30 days after ex-works.
	Short-Term Stability Allan Variance			0.5	$\times 10^{-9}$	Temperature stability, no EMI\EMC or other interference, test after power for 1hour ref. to 25°C ; 1s, using PN9000 equipment.
	Frequency Tolerance vs. Supply Voltage	-0.01		+0.01	$\times 10^{-6}$	measurement referenced to frequency observed $T_A=25^{\circ}\text{C}$, V_{cc} varied from 4.75V to 5.25V, and $O_{Load}=50\Omega$.
	Frequency Tolerance vs. Load	-0.01		+0.01	$\times 10^{-6}$	5% load change measurement referenced to frequency observed with $T_A=25^{\circ}\text{C}$, $V_{cc}=5.0\text{V}$, $O_{Load}=50\Omega$.
	Aging Tolerance Per Day	-0.01		+0.01	$\times 10^{-6}$	$T_A=25^{\circ}\text{C}$, $V_{cc}=5.0\text{V}$, and after 1h of operation.
	Aging Tolerance 1 Year	-0.8		+0.8	$\times 10^{-6}$	
Power Supply	Current Consumption			45	mA	@ 25°C , $V_{cc}=5.0\text{V}$, $O_{load}=50\Omega$.
	Supply Voltage	4.75	5.0	5.25	V	



Phase Noise	Phase Noise		-140	-130	dBc/Hz	1KHz
			-160	-155		10KHz
			-165	-160		100KHz
Environmental Conditions	Operable Temperature	-20		+70	°C	
	Storage Temperature	-55		+105	°C	
	ESD Level	Human Body Model, class2: 2000V to 4000V; ANSI/ESDA/JEDEC JS-001-2010.				
		Machine Model, class B: 200V to 400V; ANSI/ESDA/JEDEC JS-001-2010.				
	Moisture Sensitivity Level	Not humidity sensitive.				
	Vibration	Test Condition: 0.75mm ;acceleration:10g;10Hz~2000Hz, one cycle per 30 min, test 2 hour. (3 times for each 3 directions X ,Y , Z) .IEC 68-2-06 Test Fc.				
Shock	100g; 6ms; half sine wave (3 times for each 3 directions X ,Y, Z),IEC 68-2-27 Test Ea/Severity 50A.					



2. Mechanical Structure(mm)

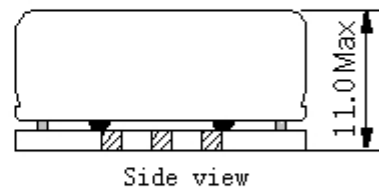
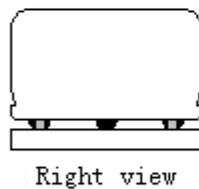
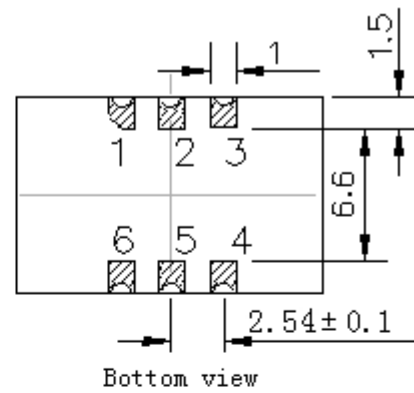
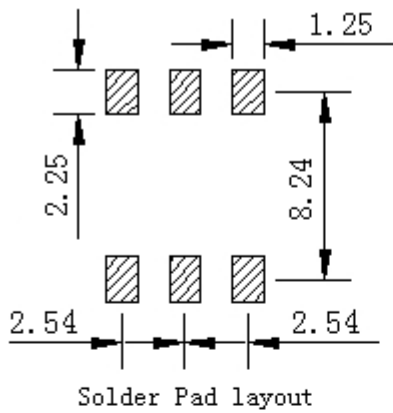

PIN FUNCTION

PIN	NOTATION	FUNCTION
1	NC	Not Connect
2,5	NC	Not Connect
3	GND	GND
4	OUTPUT	RF Output
6	VCC	Supply Voltage

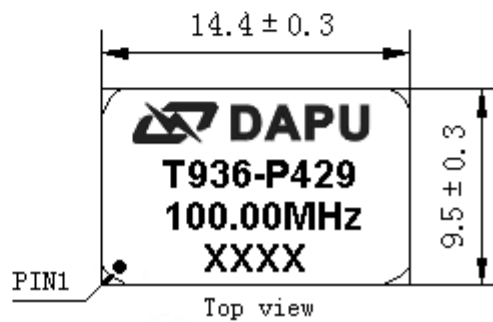

- Note1:** Tolerance $\pm 0.20\text{mm}$ without mark
- Note2:** The first two xx representative: week
After two xx representative: year
- Note3:** Referential weight 1.5g
- Note4:** NC is not connect



3. Test circuit

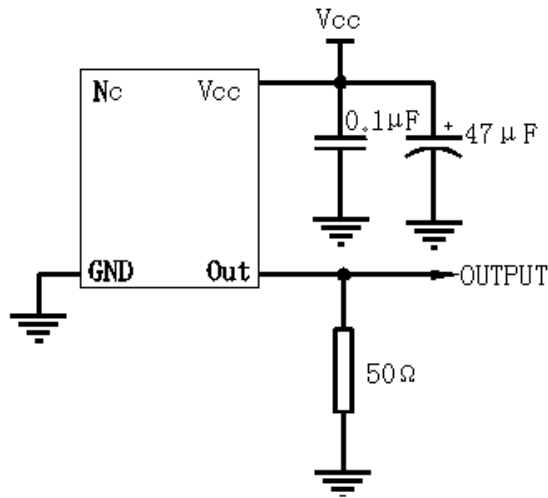

4. Reflow Soldering Curve (RoHS)

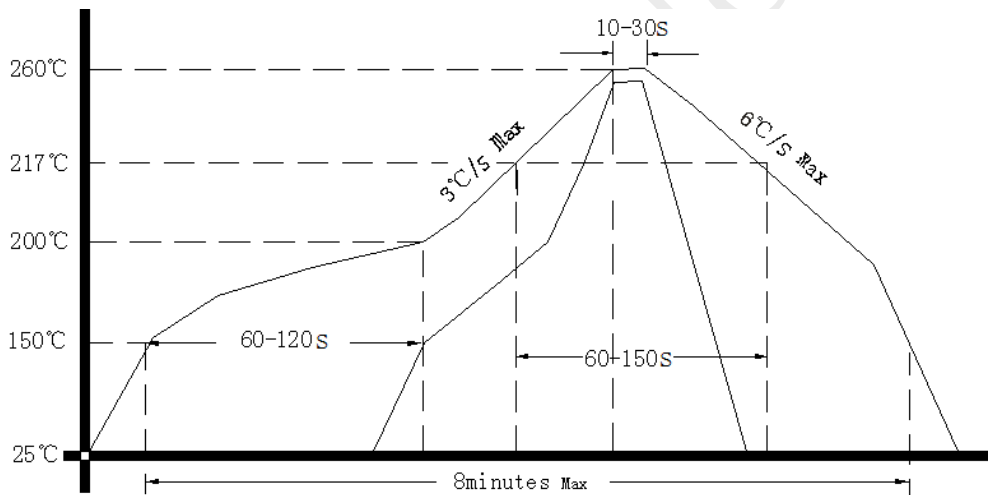

5. Package: (mm)

