

Travelling Merchant: _____

DATASHEET

Standard: **V936-B611-160.00MHz**

P/N: _____

Plot			The Label
Drew	Audited	Approved	Stamp, please! Thanks!
Date: 2013.09.16			

Guangdong Dapu Telecom Technology Co.,Ltd

Bldg13-16,.N.Ind.Zone,SSL Industry Park, Dongguan City, Guangdong Province, China

TEL: 0086-0769-88010888 FAX: 0086-0769-81800098



1. Electrical Parameters

MODEL: V936-B611-160.00MHz						
Item	Description	Parameters			Unit	Test Condition
		Min.	Typ.	Max.		
Output	Frequency	160.00			MHz	
	Output Waveform	LVPECL				
	Output Low Voltage			1.68	V	@25°C, V _{cc} =3.3V
	Output High Voltage	2.27			V	@25°C, V _{cc} =3.3V
	Duty Cycle	45	50	55	%	@50%, measurement at V _c =1.65V
	Rise / Fall Time (20%~80%)			1	ns	@25°C
	Load	50			Ω	Connect to V _{cc} -2.0V
	Start-up Time			10	ms	
	Jitter			1	ps	RMS (12KHz ~20MHz)
Frequency Stabilities	Frequency Tolerance vs. Operating Temperature Range	-30		+30	× 10 ⁻⁶	T _A varied from -40°C to 85°C, measurement referenced to frequency observed with T _A =25°C, V _{cc} =3.3V, V _c =1.65V, O _{load} =50Ω Connect to V _{cc} -2.0V, temperature variable speed less than 2°C per minute.
	Initial Frequency Tolerance	-15		+15	× 10 ⁻⁶	Measurement referenced to frequency observed with T _A = 25°C, V _{cc} = 3.3V, V _c =1.65V within 30 days after ex-works.
	Frequency Tolerance vs. Supply Voltage	-3		+3	× 10 ⁻⁶	measurement referenced to frequency observed T _A =25°C, V _{cc} varied from 3.13V to 3.47V, V _c =1.65V and O _{Load} =50Ω Connect to V _{cc} -2.0V.
	Frequency Tolerance vs. Load	-1		+1	× 10 ⁻⁶	5% load change measurement referenced to frequency observed with T _A =25°C, V _{cc} =3.3V, V _c =1.65V and O _{Load} =50Ω Connect to V _{cc} -2.0V.
	Aging Tolerance 1 Year	-5		+5	× 10 ⁻⁶	T _A =25°C, V _{cc} =3.3V, V _c =1.65V and after 1h of operation.
Power Supply	Current Consumption		80		mA	@25°C, O _{Load} =50Ω Connect to V _{cc} -2.0V
	Supply Voltage	3.13	3.3	3.47	V	



Voltage Control Characteristics	Frequency Tuning Range			-80	$\times 10^{-6}$	$V_c=0V$. measurement referenced to $V_c=1.65V$
		-15		+15	$\times 10^{-6}$	$V_c=1.65V$. measurement referenced to exactly 160.00MHz
		+80			$\times 10^{-6}$	$V_c=3.3V$. measurement referenced to $V_c=1.65V$
	Linearity			15	%	
	Slope	Positive				
	Input Impedance	100				K Ω
Phase Noise	Phase Noise			-55	dBc/Hz	10Hz
				-85		100Hz
				-105		1KHz
				-125		10KHz
				-135		100KHz
				-138		1MHz
Environmental Conditions	Operable Temperature	-40		+85	$^{\circ}C$	
	Storage Temperature	-55		+105	$^{\circ}C$	
	ESD Level	Human Body Model, class2: 2000V to 4000V; ANSI/ESDA/JEDEC JS-001-2010.				
		Machine Model, class B: 200V to 400V; ANSI/ESDA/JEDEC JS-001-2010.				
	Moisture Sensitivity Level	Level 2.				
	Vibration	Test Condition: 0.75mm ;acceleration:10g;10Hz~2000Hz, one cycle per 30 min, test 2 hour. (3 times for each 3 directions X ,Y , Z), IEC 68-2-06 Test Fc.				
Shock	100g; 6ms; half sine wave (3 times for each 3 directions X ,Y , Z),IEC 68-2-27 Test Ea/Severity 50A.					



2. Mechanical Structure (mm)

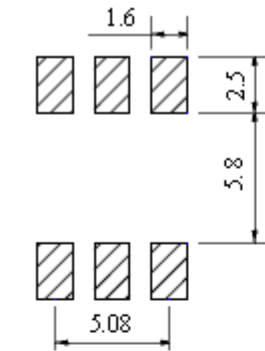

Solder pad layout

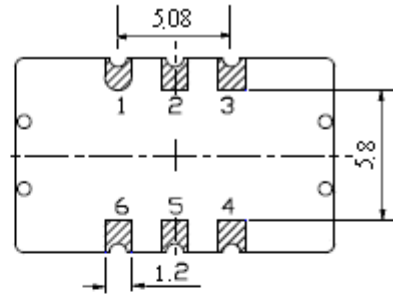

Bottom view

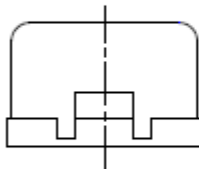

Right view

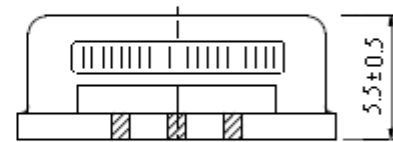

Front view

PIN FUNCTION

PIN	FUNCTION
1	VC
2	E/D
3	GND
4	OUTPUT
5	OUTPUT
6	VCC

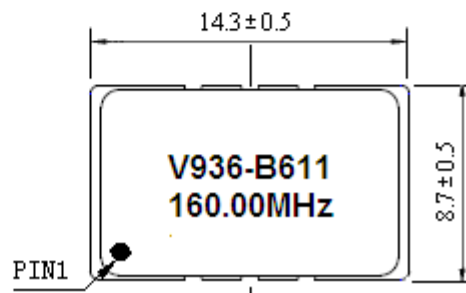

Top view

Note1: Referential Weight 1.4g

Note2: Enable: $V_{il} \leq V_{CC} - 2.0V$

Disable: $V_{ih} \geq V_{CC} - 1.025V$

E/D	OUT1	OUT2
low level, open	data	data
high level	no data	no data



3. Test Circuit

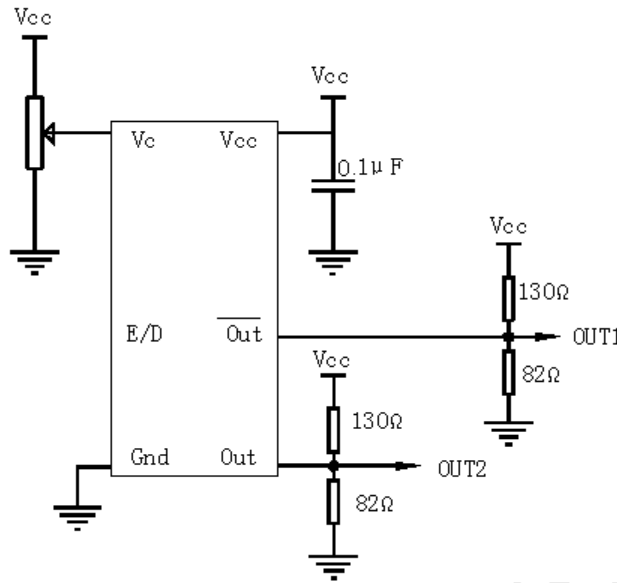

4. Reflow Soldering Curve (RoHS)

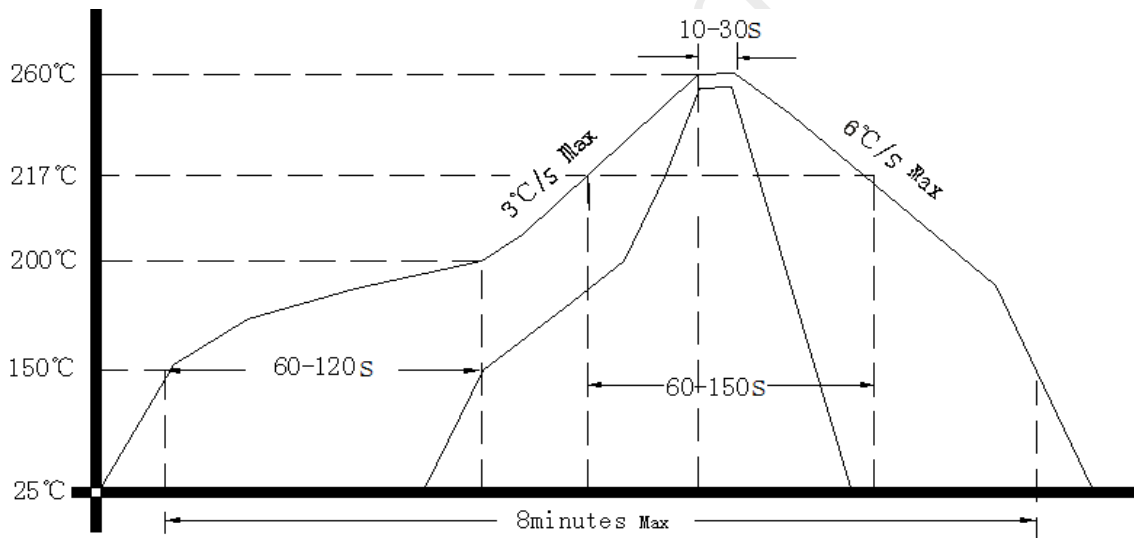

5. Package: Tape & Reel (mm)

