

Customer Code : _____

DATASHEET

DAPU P/N: **DP7C33333002**

Plot			The Label
Drew	Audited	Approved	
Date: 2018.12.10			Stamp, please! Thanks!

Guangdong Dapu Telecom Technology Co.,Ltd

Bldg16,.N.Ind.Zone,SSL Industry Park, Dongguan City, Guangdong Province, China

TEL: 0086-0769-88010888 FAX: 0086-0769-81800098



1、Electrical Parameters

MODEL: DP7C3333002							
No.	Parameters	SYM.	Electrical Spec.				Notes
			Min.	Typ.	Max.	Units	
1	Nominal Frequency	FL	33.333			MHz	
2	Output Waveform		CMOS				
3	Frequency Stability		-50		+50	$\times 10^{-6}$	Frequency stability includes frequency tolerance@25°C and frequency stability vs. operating temperature range and voltage variance and first year aging.
4	Operating Temperature	Topr	-40		+85	°C	The operating temperature range over which the frequency stability is measured.
5	Storage Temperature	Tstg	-55		+125	°C	
6	Supply Voltage	VDD	2.97	3.3	3.63	V	
7	Current	Icc			10	mA	At maximum supply voltage
8	Output Load				15	pF	
9	Aging	-	-3	-	+3	$\times 10^{-6}$	Frequency drift in first year
10	Output Voltage High	VoH	2.97	-	-	V	
11	Output Voltage Low	Vol	-	-	0.33	V	
12	Duty Cycle	-	45	50	55	%	
13	Rise /Fall Time				5.0	ns	
14	Start Time	Tosc	-	-	5.0	ms	
15	Tri-State Output Active		2.31 or Floating			V	Pin 1 Tri-state
16	Tri-State Output in High-Impedance state				0.99	V	



17	Vibration Test	MIL-STD-883 2007 Condition A	10~2000Hz, 1.52mm, 20g, each axis for 4 hrs
		JESD22-B103 Condition 1	
18	Thermal Shock	MIL-STD-883 1010 Condition B	-55°C, 125°C; soak time is 10 mins, with total 200 cycles
		JESD22-A104 Condition B	
19	Mechanical Shock	MIL-STD-883 2002 Condition B	1500g half-sine, 0.5ms, each axis for 3 times.
		JESD22-B104 Condition B	

2、Mechanical Structure(mm)

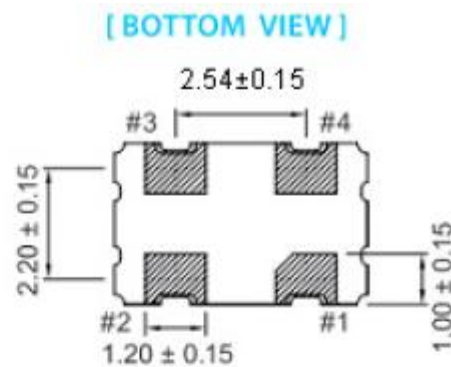
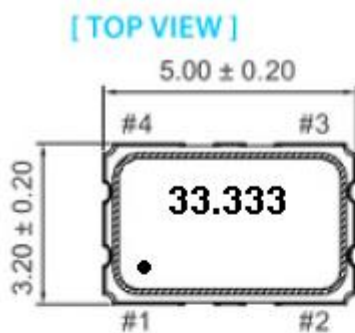

[SIDE VIEW]

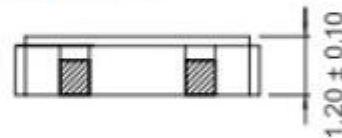

PIN FUNCTIONS

Pin	Function
#1	TRI-STATE
#2	GND
#3	Output
#4	V _{DD}

Unit:mm

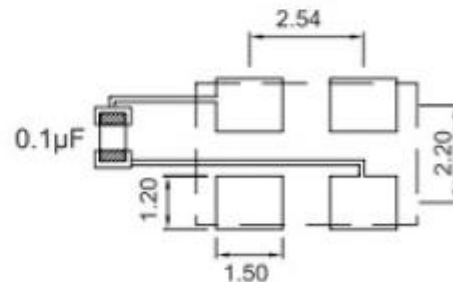

To ensure optimal oscillator performance, place a by-pass capacitor of 0.1µF as close to the part as possible between V_{DD} and GND pads.



3、 Test Circuit

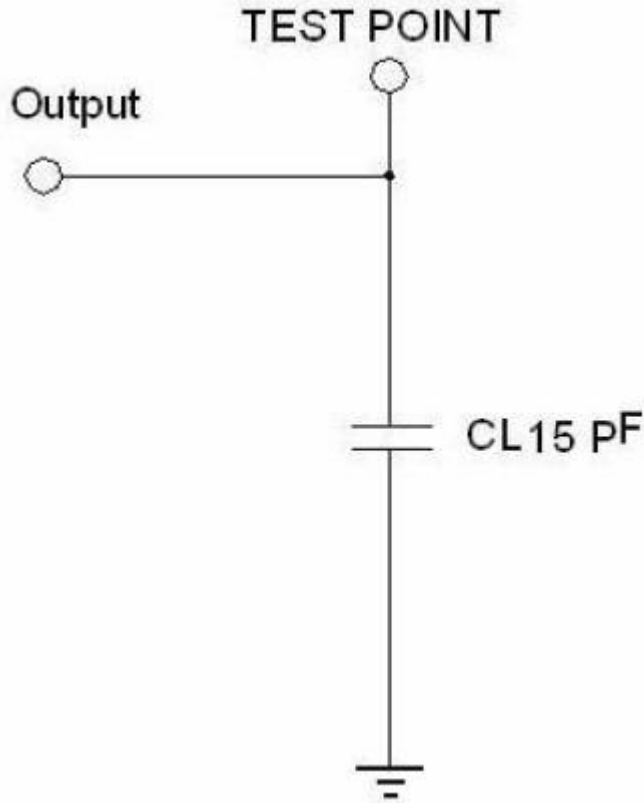

4、 Output Waveform(CMOS Load)

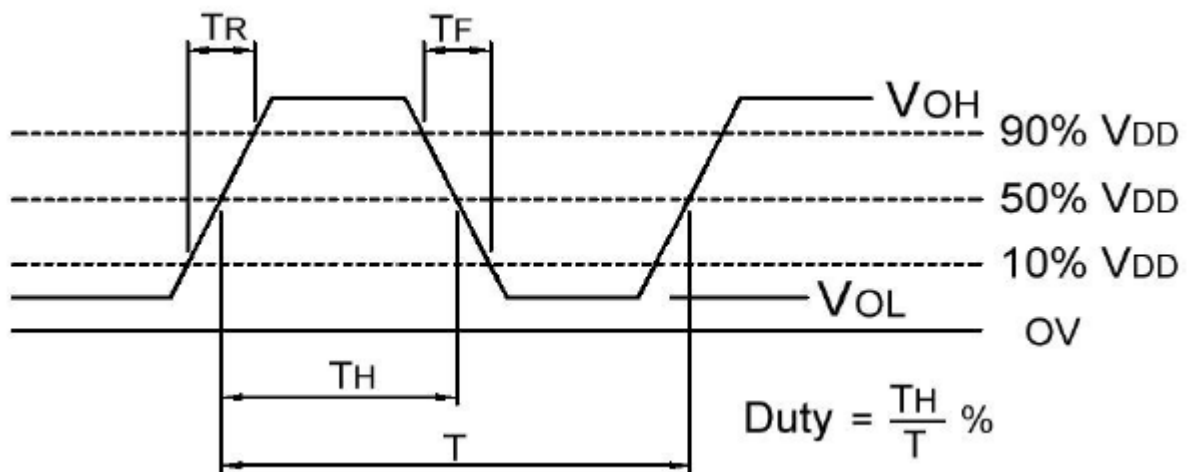



5、 Recommended Ir Reflow Profile

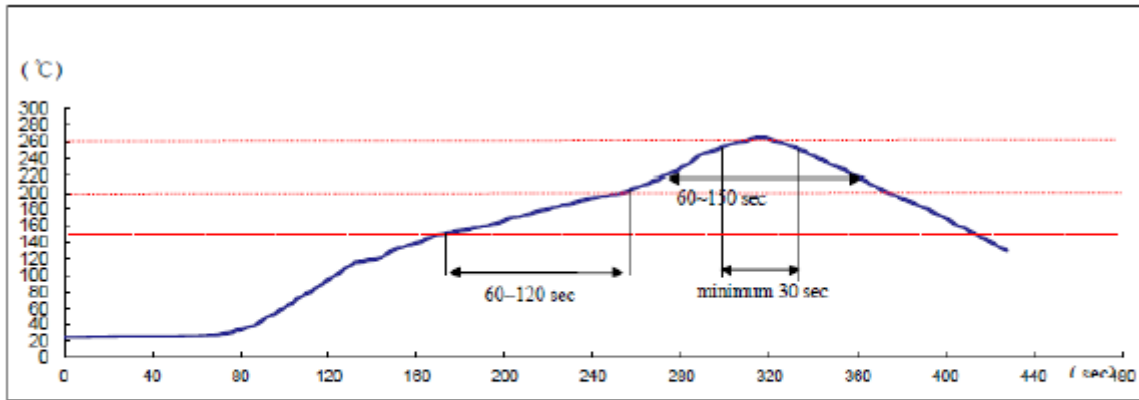

Reference Standard: JEDEC-STD 020

Test conditions: Pre-heating : 150°C to 200°C, 60~120secs.

Heating : 217°C, 60~150sec.

Peak temperature at least : 260°C, The time above 255 °C : minimum 30sec.

6、 Package: Tape & Reel (mm)

