

Customer Code : _____

DATASHEET

DAPU P/N: **O11F-L411-40.00MHz**

Customer P/N: _____

DAPU			Customer Approval
Drew	Audited	Approved	Stamp, please! Thanks!
Date: 2018.12.06			

Guangdong Dapu Telecom Technology Co.,Ltd

Bldg13-16,.N.Ind.Zone,SSL Industry Park, Dongguan City, Guangdong Province, China

TEL: 0086-0769-88010888 FAX: 0086-0769-81800098



Table of amendment

Version	Revision contents	Prepared by	Revised date
1.0	The first issued	<i>Amway</i>	2014.11.05
1.1	“2.Typical Performance Data” and “Full Package Storage” added	<i>Amway</i>	2015.01.23
1.2	Modified the 1 st page “Typical Performance Data” deleted “Marking” changed	<i>Amway</i>	2015.07.03
1.3	“2.Typical Performance Data” and “Full Package Storage” added	<i>Amway</i>	2018.11.02
1.4	“Frequency Stabilities” changed	<i>Amway</i>	2018.12.06



1. Electrical Parameters

MODEL: O11F-L411-40.00MHz						
Item	Description	Parameters			Unit	Test Condition
		Min.	Typ.	Max.		
Output	Frequency	40.00			MHz	
	Output Waveform	Sine wave				
	Level	6		10	dBm	
	Load	50			Ω	
	Harmonics Suppression			-30	dBc	
	Spurious Suppression			-60	dBc	
Frequency Stabilities	Frequency Tolerance vs. Operating Temperature Range	-0.05		+0.05	$\times 10^{-6}$	T_A varied from -40°C to 85°C , measurement referenced to frequency observed with $f_{\text{ref}}=(f_{\text{max}}+f_{\text{min}})/2$, $V_{\text{cc}}=3.3\text{V}$, $V_c=1.65\text{V}$, $O_{\text{load}}=50\Omega$, temperature variable speed less than 2°C per minute.
	Initial Frequency Tolerance	-0.5		+0.5	$\times 10^{-6}$	Measurement referenced to frequency observed with $T_A=25^\circ\text{C}$, $V_{\text{cc}}=3.3\text{V}$, $V_c=1.65\text{V}$ and after 15 minutes of operation, within 30 days after ex-works.
	Frequency Tolerance vs. supply voltage	-10		+10	$\times 10^{-9}$	measurement referenced to frequency observed $T_A=25^\circ\text{C}$, V_{cc} varied from 3.13V to 3.47V, $V_c=1.65\text{V}$, $O_{\text{load}}=50\Omega$.
	Frequency Tolerance vs. Load	-10		+10	$\times 10^{-9}$	5% Load Change Measurement referenced to frequency observed with $T_A=25^\circ\text{C}$, $V_{\text{cc}}=3.3\text{V}$, $V_c=1.65\text{V}$, $O_{\text{load}}=50\Omega$.
	Short Term Stability			0.1	$\times 10^{-9}$	Temperature stability, no EMI\EMC or other interference, test after power for 1hour ref. to 25°C ; 1s, using PN9000 equipment.
	Aging Tolerance per day	-5		+5	$\times 10^{-9}$	V_{cc}, V_c, T_A constant Measurement referenced to frequency observed with $T_A=25^\circ\text{C}$,
	Aging Tolerance 1Year	-0.5		+0.5	$\times 10^{-6}$	$V_{\text{cc}}=3.3\text{V}, V_c=1.65\text{V}, O_{\text{load}}=50\Omega$ and after 30 days of operation.
Power Supply	Supply Voltage	3.13	3.3	3.47	V	
	Current Consumption			300	mA	@ 25°C
	Current Consumption during warm up			600	mA	
	Warm-Up Time			5	minutes	@ 25°C within $\pm 0.1 \times 10^{-6}$ of final frequency with reference after 1 hour on.



Voltage Control Characteristics	Frequency Tuning Range	-8		-3	$\times 10^{-6}$	$V_c=0V$. measurement referenced to $V_c=1.65V$.
		-0.5		+0.5	$\times 10^{-6}$	$V_c=1.65V$. measurement referenced to exactly 40.00MHz.
		+3		+8	$\times 10^{-6}$	$V_c=3.3V$. measurement referenced to $V_c=1.65V$.
	Linearity			10	%	
	Slope	Positive				
	Input Impedance	100				K Ω
Phase Noise	Phase Noise @25°C		-100	-90	dBc/Hz	10Hz
			-120	-110		100Hz
			-145	-140		1KHz
			-150	-145		10KHz
			-150	-145		100KHz
			-155	-150		1MHz
Environmental Conditions	Operable Temperature	-40		+85	°C	
	Storage Temperature	-55		+105	°C	
	ESD Level	Human Body Model, class2: 2000V to 4000V; ANSI/ESDA/JEDEC JS-001-2010.				
		Machine Model, class B: 200V to 400V; ANSI/ESDA/JEDEC JS-001-2010.				
	Moisture Sensitivity Level	Level 2.				
	Vibration	Test Condition: 0.75mm ;acceleration:10g;10Hz~500Hz, one cycle per 30 min, test 2 hour. (3 times for each 3 directions X ,Y , Z), IEC 68-2-06 Test Fc.				
Shock	50g; 11ms; half sine wave (3 times for each 3 directions X ,Y, Z),IEC 68-2-27 Test Ea/Severity 50A.					
Full Package Storage	Relative humidity (%)	20% ~70%				
	Temperature (°C)	-10~35°C				



2. Typical Performance Data

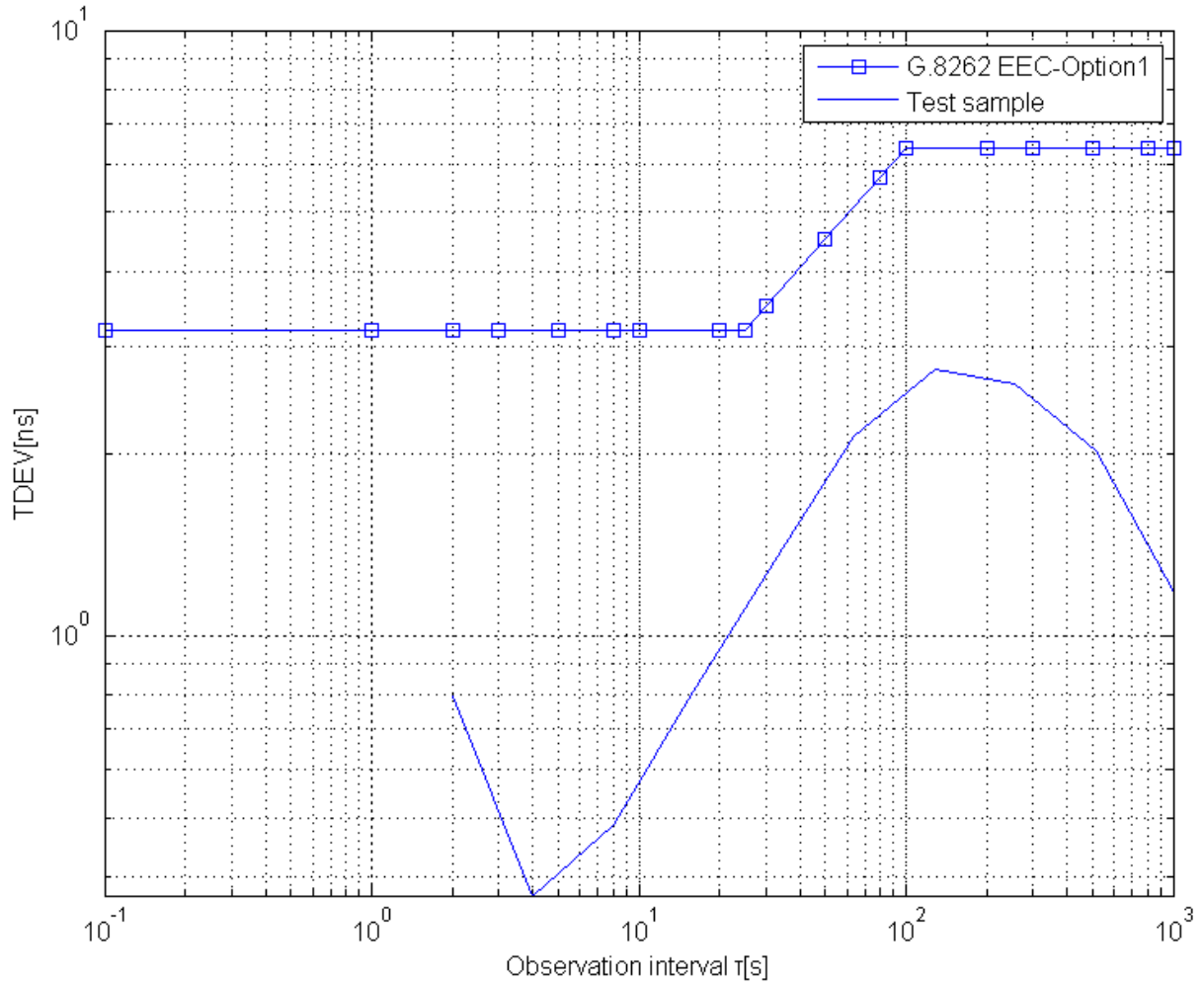

TDEV per G.8262 Option 1

DAPU

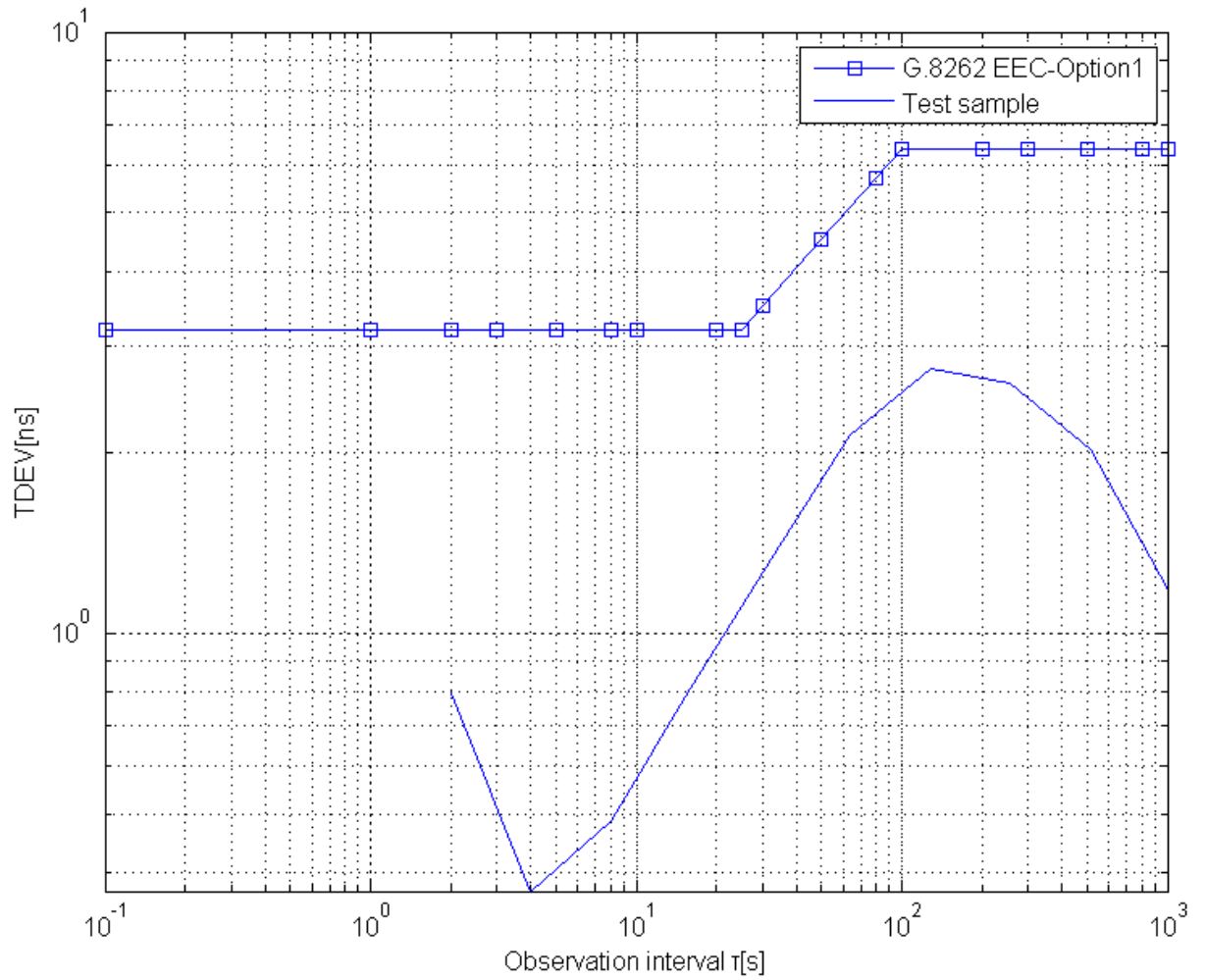

TDEV per G.8262 Option 1

DAPU



3. Mechanical Structure (mm)

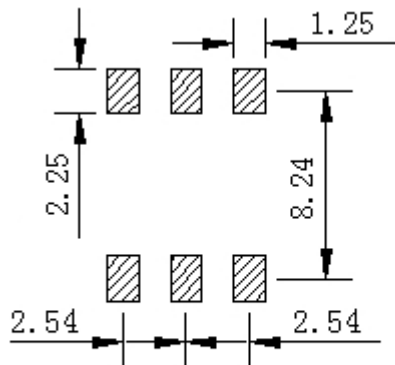

Solder Pad layout

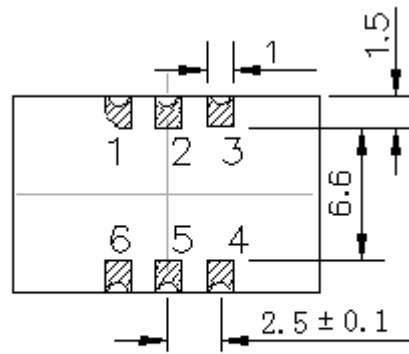

Bottom view

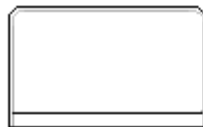

Right view



Side view

PIN FUNCTION

PIN	NOTATION	FUNCTION
1	VC	Control Voltage
2,5	NC	Not Connect
3	GND	GND
4	OUTPUT	RF Output
6	VCC	Supply Voltage

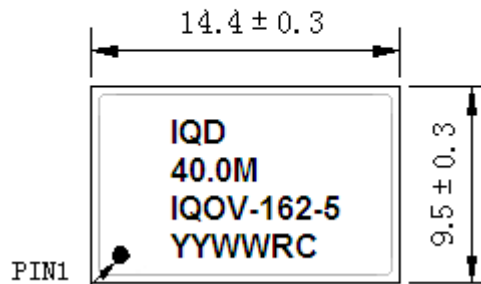

Top view

4. Test Circuit

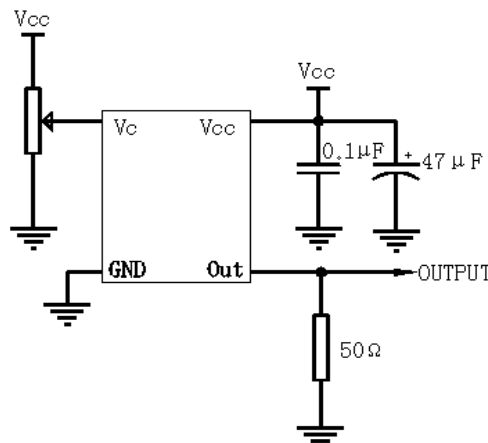



5. Reflow Soldering Curve (RoHS)

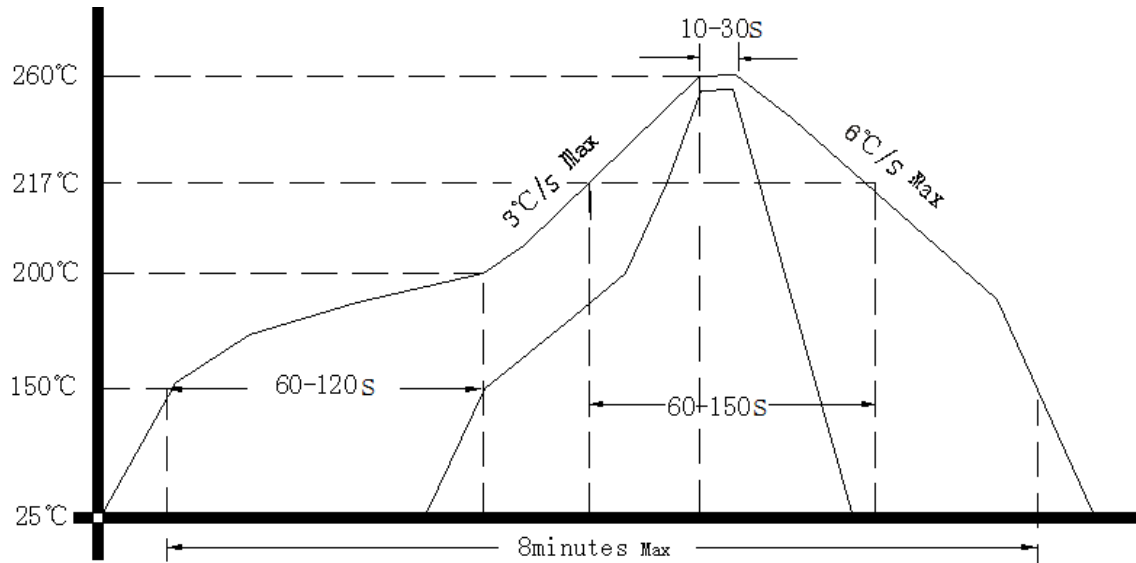

6. Package: Tape & Reel (mm)

