

Customer Code : _____

DATASHEET

DAPU P/N: **O22B-P428-100.00MHz-B**

Customer P/N: _____

DAPU			Customer Approval
Drew	Audited	Approved	Stamp, please! Thanks!
Date: 2018.10.26			

Guangdong Dapu Telecom Technology Co.,Ltd

Bldg 16,.N.Ind.Zone,SSL Industry Park, Dongguan City, Guangdong Province, China

TEL: 0086-0769-88010888 FAX: 0086-0769-81800098



1. Electrical Parameters

MODEL: O22B-P428-100.00MHZ-B						
Item	Description	Parameters			Unit	Test Condition
		Min.	Typ.	Max.		
Output	Frequency	100.00			MHz	
	Output Waveform	Sine wave				
	Level	8	13		dBm	
	Load	50			Ω	
	Harmonics Suppression			-50	dBc	
	Spurious Suppression			-80	dBc	
Frequency Stabilities	Frequency Tolerance vs. Operating Temperature Range	-5.0		+5.0	$\times 10^{-9}$	T_A varied from -40°C to 85°C , measurement referenced to frequency observed with $f_{\text{ref}}=(f_{\text{max}}+f_{\text{min}})/2$, $V_{\text{cc}}=5.0\text{V}$, $V_c=2.5\text{V}$, $O_{\text{load}}=50\Omega$, temperature variable speed less than 2°C per minute.
	Initial Frequency Tolerance	-0.2		+0.2	$\times 10^{-6}$	Measurement referenced to frequency observed with $T_A=25^\circ\text{C}$, $V_{\text{cc}}=5.0\text{V}$, $V_c=2.5\text{V}$ and after 15 minutes of operation, within 30 days after ex-works.
	Frequency Tolerance vs. supply voltage	-0.03		+0.03	$\times 10^{-6}$	measurement referenced to frequency observed $T_A=25^\circ\text{C}$, V_{cc} varied from 4.75V to 5.25V, $V_c=2.5\text{V}$, $O_{\text{load}}=50\Omega$.
	Frequency Tolerance vs. Load	-0.01		+0.01	$\times 10^{-6}$	5% Load Change Measurement referenced to frequency observed with $T_A=25^\circ\text{C}$, $V_{\text{cc}}=5.0\text{V}$, $V_c=2.5\text{V}$, $O_{\text{load}}=50\Omega$.
	Short Term Stability			0.01	$\times 10^{-9}$	Temperature stability, no EMI\EMC or other interference, test after power for 1hour ref. to 25°C ; 1s, using PN9000 equipment.
	Aging Tolerance per day	-1.0		+1.0	$\times 10^{-9}$	V_{cc}, V_c, T_A constant Measurement referenced to frequency observed with $T_A=25^\circ\text{C}$, $V_{\text{cc}}=5.0\text{V}$, $V_c=2.5\text{V}$, $O_{\text{load}}=50\Omega$ and after 30 days of operation.
	Aging Tolerance 1Year	-0.1		+0.1	$\times 10^{-6}$	
Power Supply	Supply Voltage	4.75	5.0	5.25	V	
	Steady Consumption			600	mA	@ 25°C
	Warm up current			1200	mA	
	Warm-Up Time			15	minutes	@ 25°C within $\pm 0.05 \times 10^{-6}$ of final frequency with reference after 1 hour on.



Voltage Control Characteristics	Frequency Tuning Range			-1.0	$\times 10^{-6}$	$V_c=0V$. measurement referenced to $V_c=2.5V$.
		-0.2		+0.2	$\times 10^{-6}$	$V_c=2.5V$. measurement referenced to exactly 100.00MHz.
		+1.0			$\times 10^{-6}$	$V_c=5.0V$. measurement referenced to $V_c=2.5V$.
	Linearity			10	%	
	Slope	Positive				
	Input Impedance	100				K Ω
Phase Noise	Phase Noise		-100	-95	dBc/Hz	10Hz
			-135	-130		100Hz
			-160	-155		1KHz
			-170	-165		10KHz
			-175	-170		100KHz
			-175	-170		1MHz
Environmental Conditions	Operable Temperature	-40		+85	$^{\circ}C$	
	Storage Temperature	-55		+105	$^{\circ}C$	
	ESD Level	Human Body Model, class2: 2000V to 4000V; ANSI/ESDA/JEDEC JS-001-2010.				
		Machine Model, class B: 200V to 400V; ANSI/ESDA/JEDEC JS-001-2010.				
	Moisture Sensitivity Level	Not humidity sensitive.				
	Vibration	Test Condition: 0.75mm ;acceleration:10g;10Hz~500Hz, one cycle per 30 min, test 2 hour. (3 times for each 3 directions X ,Y , Z), IEC 68-2-06 Test Fc.				
Shock	50g; 11ms; half sine wave (3 times for each 3 directions X ,Y, Z),IEC 68-2-27 Test Ea/Severity 50A.					
Full Package Storage	Relative humidity (%)	20% ~70%				
	Temperature ($^{\circ}C$)	-10~35 $^{\circ}C$				



2. Mechanical Structure (mm)

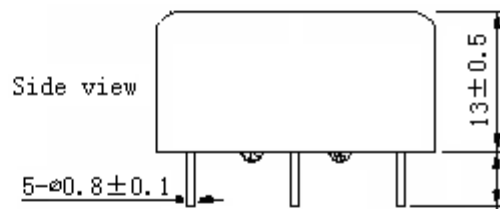
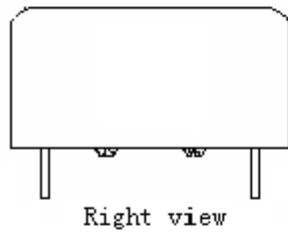
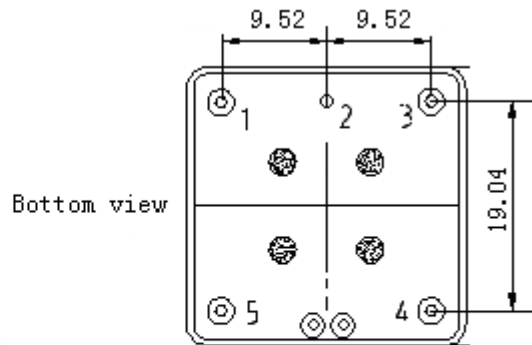

PIN FUNCTION

PIN	NOTATION	FUNCTION
1	OUTPUT	RF Output
2	GND	GND
3	VC	Control Voltage
4	NC	Not Connect
5	VCC	Supply Voltage

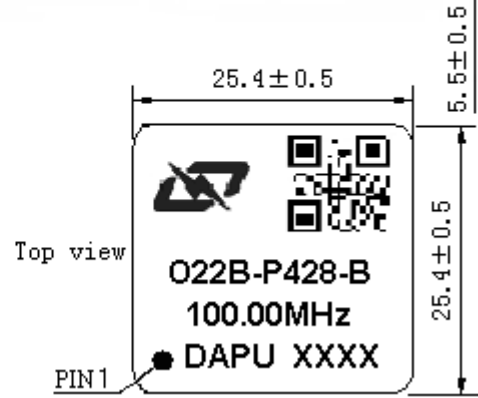

- Note1:** Tolerance $\pm 0.20\text{mm}$ without mark
- Note2:** The first two xx representative: week
After two xx representative: year
- Note3:** Referential weight 13.6g
- Note4:** NC is not connect



3. Test Circuit

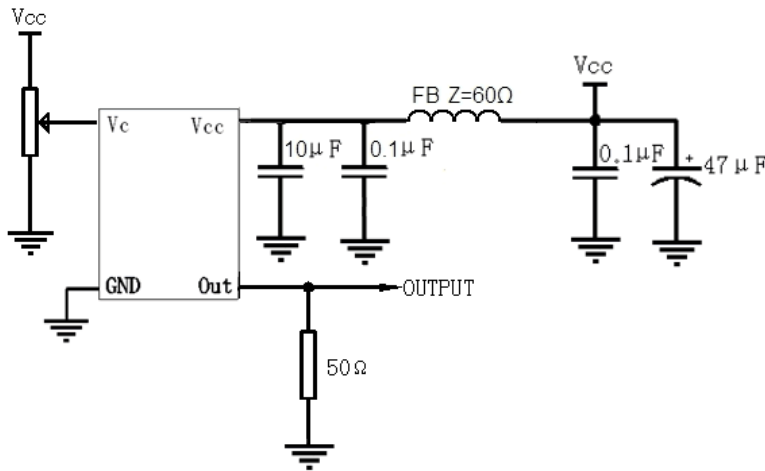

4. Reflow Soldering Curve (RoHS)

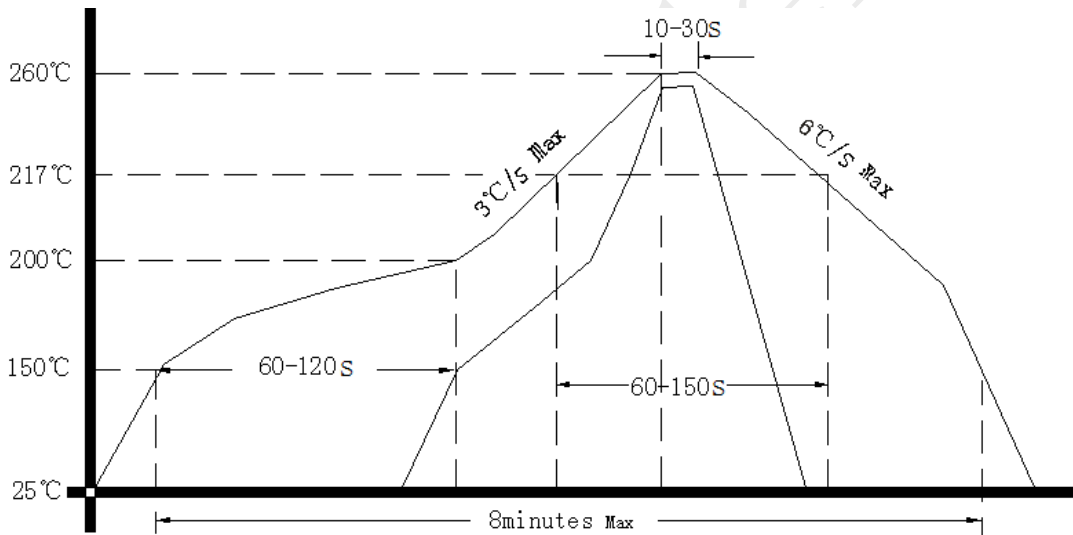

5. Package(mm)

