







## 1. Electrical Parameters

MODEL: T75A-2103-12.80MHz							
Item	Description	Parameters			Unit	Test Condition	
		Min.	Typ.	Max.			
Output	Frequency	12.80			MHz		
	Output Waveform	HCMOS					
	Output Low Voltage			0.33	V	$V_{cc}=3.3V, O_{load}=15\text{ pF}$	
	Output High Voltage	2.97			V	$V_{cc}=3.3V, O_{load}=15\text{ pF}$	
	Duty Cycle	45	50	55	%	@50%	
	Rise / Fall Time (10%~90%)			5	ns	@25°C	
	Load	15			pF		
	Start Time			2	ms		
Frequency Stabilities	Frequency Tolerance vs. Operating Temperature Range	-0.2		+0.2	$\times 10^{-6}$	$T_A$ varied from -40°C to 85°C, measurement referenced to frequency observed with $f_{ref} = (f_{max} + f_{min})/2$ , $V_{cc}=3.3V, O_{load}=15\text{ pF}$ , temperature variable speed less than 2°C per minute.	
	Initial Frequency Tolerance	-1.0		+1.0	$\times 10^{-6}$	Measurement referenced to frequency observed with $T_A=25^\circ\text{C}, V_{cc}=3.3V$ within 30 days after ex-works.	
	Frequency Tolerance vs. Supply Voltage	-0.05		+0.05	$\times 10^{-6}$	measurement referenced to frequency observed $T_A=25^\circ\text{C}, V_{cc}$ varied from 3.13V to 3.47V, and $O_{Load}=15\text{ pF}$ .	
	Frequency Tolerance vs. Load	-0.05		+0.05	$\times 10^{-6}$	5% load change measurement referenced to frequency observed with $T_A=25^\circ\text{C}, V_{cc}=3.3V, O_{Load}=15\text{ pF}$ .	
	Frequency slope			0.02	$\times 10^{-6}/^\circ\text{C}$	$\Delta F/\Delta T$ , measured in 1°C steps / 1 minute soak per step.	
	Holdover 24hours Drift		-0.04		+0.04	$\times 10^{-6}/\text{day}$	$\Delta T \leq \pm 0.5^\circ\text{C}, \Delta V_s \leq \pm 1\%$ , after 48 hours of continuous operation.
			-0.3		+0.3	$\times 10^{-6}$	Inclusive of the following: - operating temperature -40°C to 85°C - 3.3V±5% - 24 hours aging
Overall Stability		-4.6		+4.6	$\times 10^{-6}$	Inclusive of the following: - initial tolerance (@25°C) - operating temperature -40°C to 85°C - 3.3V±5% - 15pF load ±5% - Reflow soldering - 20 years aging	



Power Supply	Current Consumption			10	mA	@25°C, V <sub>cc</sub> =3.3V, O <sub>Load</sub> =15pF.
	Supply Voltage	3.13	3.3	3.47	V	
Phase Noise	Phase Noise @25°C		-85	-82	dBc/Hz	10Hz
			-115	-110		100Hz
			-135	-130		1KHz
			-145	-140		10KHz
			-150	-145		100KHz
			-150	-145		1MHz
Environmental Conditions	Operable Temperature	-40		+85	°C	
	Storage Temperature	-55		+105	°C	
	ESD Level	Human Body Model, class2: 2000V to 4000V; ANSI/ESDA/JEDEC JS-001-2010.				
		Machine Model, class B: 200V to 400V; ANSI/ESDA/JEDEC JS-001-2010.				
	Moisture Sensitivity Level	Level 2.				
	Vibration	Test Condition: 0.75mm ;acceleration:10g;10Hz~2000Hz, one cycle per 30 min, test 2 hour. (3 times for each 3 directions X , Y , Z) .IEC 68-2-06 Test Fc.				
Shock	100g; 6ms; half sine wave (3 times for each 3 directions X , Y , Z ),IEC 68-2-27 Test Ea/Severity 50A.					
Full Package Storage	Relative humidity (%)	20%~70%				
	Temperature (°C)	-10~35°C				



## 2. Mechanical Structure(mm)

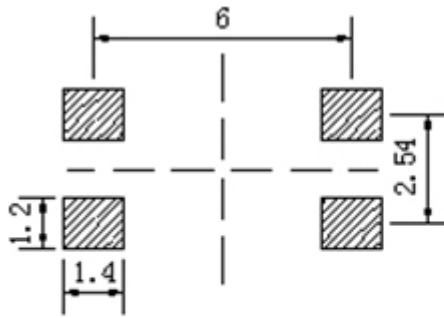

Solder pad layout

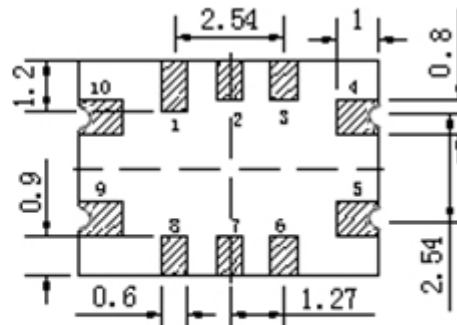

Bottom view

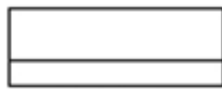

Right view

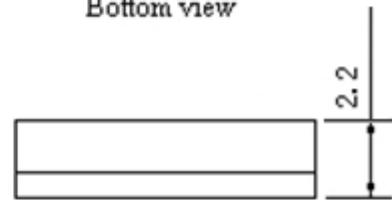

Front view

### PIN FUNCTION

PIN	NOTATION	FUNCTION
1, 2, 3, 6, 7, 8	NC	Not Connect
4	GND	GND
5	OUTPUT	RF Output
9	VCC	Supply Voltage
10	NC	Not Connect

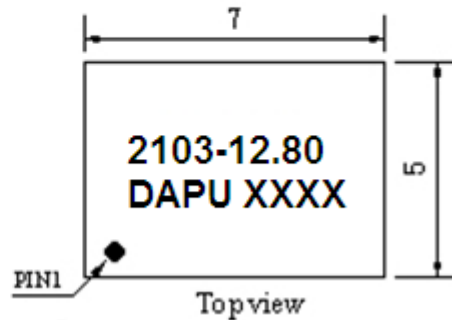

Topview

**Note1:** Tolerance  $\pm 0.2\text{mm}$  without mark

**Note2:** The first two xx representative: week

After two xx representative: year

**Note3:** Referential Weight 0.2g

**Note4:** NC is not connect

**Note5:** Material composition :

Pad/terminals: Cu (Surface plating: Ni 3-6um, Au 0.1~0.5um)

Base: High-TG FR4



### 3. Test circuit

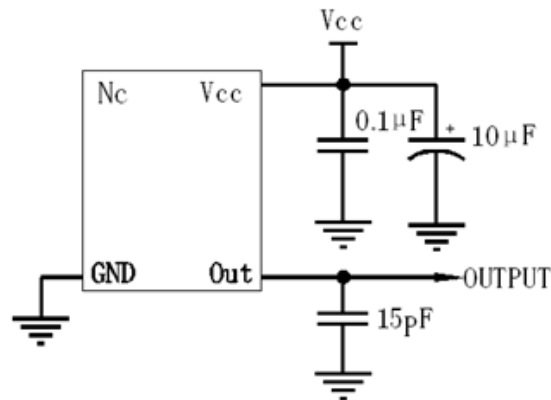

### 4. Reflow Soldering Curve (RoHS)

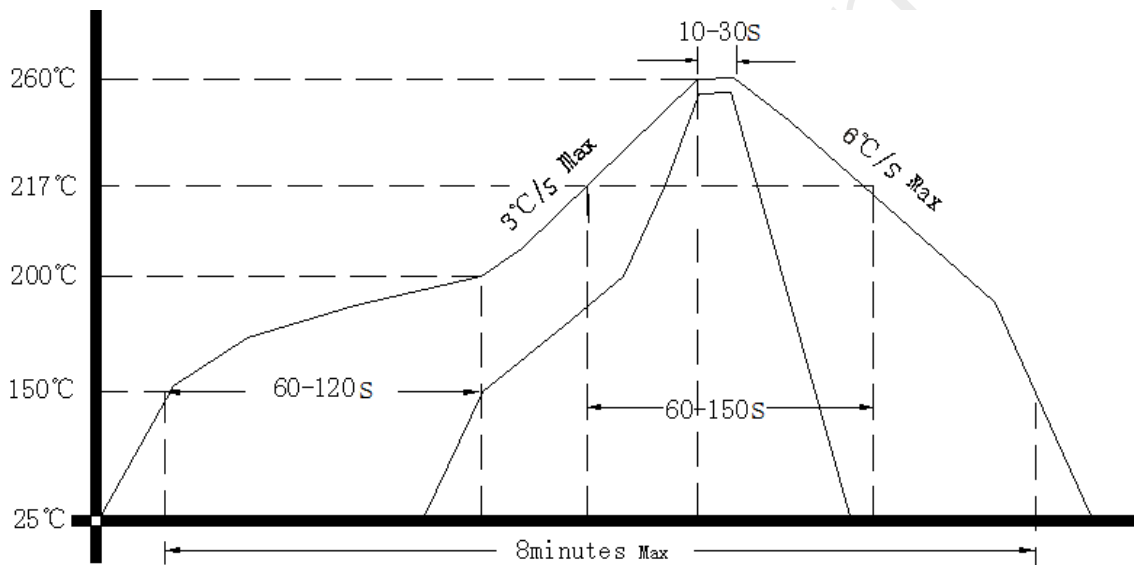

### 5. Package: Tape & Reel (mm)

