

Travelling Merchant: _____

DATASHEET

Standard: DP9B04000002

Plot			The Label
Drew	Audited	Approved	Stamp, please! Thanks!
Date: 2011.11.23			

Guangdong Dapu Telecom Technology Co.,Ltd

Bldg13-16,.N.Ind.Zone,SSL Industry Park, Dongguan City, Guangdong Province, China

TEL: 0086-0769-88010888 FAX: 0086-0769-81800098



1. Electrical Parameters

MODEL: DP9B0400002							
No.	Parameters	SYM.	Electrical Spec.				Notes
			Min.	Typ.	Max.	Units	
1	Nominal Frequency	FL	4.000000			MHz	
2	Oscillation Mode	-	Fundamental			-	
3	Load Capacitance	CL	20			pF	
4	Frequency Stability	-	-20	-	+20	$\times 10^{-6}$	at 25°C \pm 2°C
5	Operating Temperature Range	-	-20	~	+70	°C	
6	Storage Temperature	-	-40	~	+85	°C	
7	Aging	-	-3	-	+3	$\times 10^{-6}$	1st Year
8	Drive Level	DL	-	100	-	uW	
9	Effective Series Resistance	ESR	-	-	60	Ω	
10	Shunt Capacitance C0	C0	-	-	5	pF	
11	Insulation Resistance		500			M Ω	at DC 100V
12	ESD Level	Human Body Model,class2: 2000V to 4000V; ANSI/ESDA/JEDEC JS-001-2010.					
13		Machine Model, class B: 200V to 400V; ANSI/ESDA/JEDEC JS-001-2010.					
14	Moisture Sensitivity Level	Not humidity sensitive.					
15	Vibration	Test Condition: 0.75mm ;acceleration:10g;10Hz~2000Hz, one cycle per 30 min, test 2 hour. (3 times for each 3 directions X ,Y , Z).IEC 68-2-06 Test Fc.					
16	Shock	100g; 6ms; half sine wave (3 times for each 3 directions X ,Y , Z),IEC 68-2-27 Test Ea/Severity 50A.					



2. Mechanical Structure (mm)

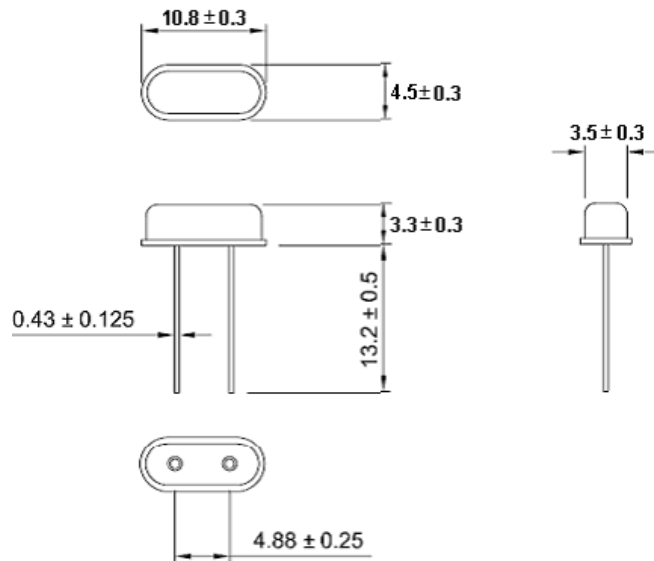

3. Wave Soldering Curve (RoHS)

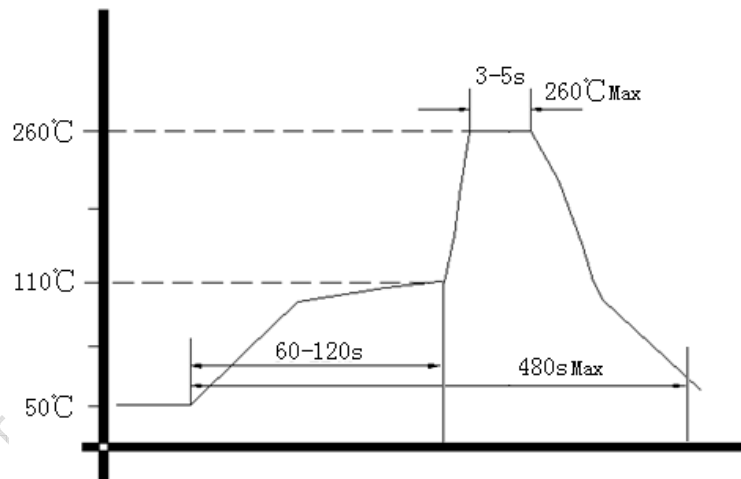

4. Package

