

Customer Code : _____

DATASHEET

DAPU P/N : **T32-B513-10.00MHz**

Customer P/N: _____

DAPU			Customer Approval
Drew	Audited	Approved	Stamp, please! Thanks!
Date: 2016.06.23			

Guangdong Dapu Telecom Technology Co.,Ltd

Bldg13-16,.N.Ind.Zone,SSL Industry Park, Dongguan City, Guangdong Province, China

TEL: 0086-0769-88010888 FAX: 0086-0769-81800098



1. Electrical Parameters

MODEL: T32-B513-10.00MHz						
Item	Description	Parameters			Unit	Test Condition
		Min.	Typ.	Max.		
Output	Frequency	10.00			MHz	
	Output Waveform	Clipped Sine Wave				
	Vp-p	0.8			V	
	Load	10KΩ//10pF				
Frequency Stabilities	Frequency Tolerance vs. Operating Temperature Range	-0.28		+0.28	$\times 10^{-6}$	T_A varied from -40 to 85°C, measurement referenced to frequency observed with $f_{ref}=(f_{max}+f_{min})/2$, $V_{cc}=3.3V$, $V_c=1.5V$, $O_{load}=10K\Omega//10pF$, temperature variable speed less than 2°C per minute.
	Initial Frequency Tolerance	-1		+1	$\times 10^{-6}$	Measurement referenced to frequency observed with $T_A=25^\circ C$, $V_{cc}=3.3V$, $V_c=1.5V$ within 30 days after ex-works.
	Frequency Tolerance vs. Supply Voltage	-0.1		+0.1	$\times 10^{-6}$	measurement referenced to frequency observed $T_A=25^\circ C$, V_{cc} varied from 3.13V to 3.47V, $V_c=1.5V$ and $O_{Load}=10K\Omega//10pF$.
	Frequency Tolerance vs. Load	-0.1		+0.1	$\times 10^{-6}$	5% load change measurement referenced to frequency observed with $T_A=25^\circ C$, $V_{cc}=3.3V$, $V_c=1.5V$, $O_{Load}=10K\Omega//10pF$.
	Aging Tolerance Per Day	-0.02		+0.02	$\times 10^{-6}$	$T_A=25^\circ C$, $V_{cc}=3.3V$, $V_c=1.5V$ and after 1h of operation.
	Aging Tolerance 1 Year	-1		+1	$\times 10^{-6}$	
Power Supply	Current Consumption			3	mA	@25°C, $V_{cc}=3.3V$, $V_c=1.5V$, $O_{load}=10K\Omega//10pF$.
	Supply Voltage	3.13	3.3	3.47		V
Phase Noise	Phase Noise		-90	-85	dBc/Hz	10Hz
			-120	-115		100Hz
			-140	-135		1KHz
			-145	-140		10KHz
			-148	-143		100KHz



Voltage Control Characteristics	Frequency Tuning Range	-15		-10	$\times 10^{-6}$	$V_c=0.5V$. measurement referenced to $V_c=1.5V$
		-1		+1	$\times 10^{-6}$	$V_c=1.5V$. measurement referenced to exactly 10.00MHz
		+10		+15	$\times 10^{-6}$	$V_c=2.5$. measurement referenced to $V_c=1.5V$
	Linearity			10	%	
	Slope	Positive				
	Input Impedance	100			$K\Omega$	
Environmental Conditions	Operable Temperature	-40		+85	$^{\circ}C$	
	Storage Temperature	-55		+105	$^{\circ}C$	
	ESD Level	Human Body Model, class2: 2000V to 4000V; ANSI/ESDA/JEDEC JS-001-2010.				
		Machine Model, class B: 200V to 400V; ANSI/ESDA/JEDEC JS-001-2010.				
	Moisture Sensitivity Level	Level 2.				
	Vibration	Test Condition: 0.75mm ;acceleration:10g;10Hz~2000Hz, one cycle per 30 min, test 2 hour. (3 times for each 3 directions X , Y , Z) .IEC 68-2-06 Test Fc.				
Shock	100g; 6ms; half sine wave (3 times for each 3 directions X , Y , Z),IEC 68-2-27 Test Ea/Severity 50A.					
Full Package Storage	Relative humidity (%)	20% ~ 70%				
	Temperature ($^{\circ}C$)	-10~35 $^{\circ}C$				



2. Mechanical Structure(mm)

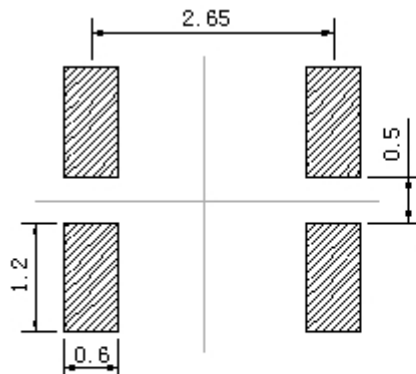

Solder Pad Layout

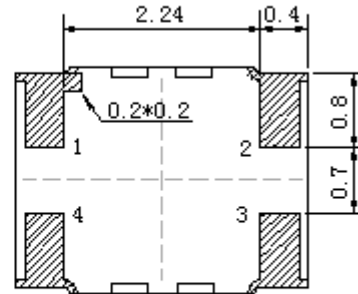

Bottom View

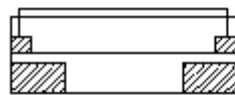

Right View



Side View

PIN FUNCTION

PIN	NOTATION	FUNCTION
1	VC	Control Voltage
2	GND	GND
3	OUTPUT	RF Output
4	VCC	Supply Voltage

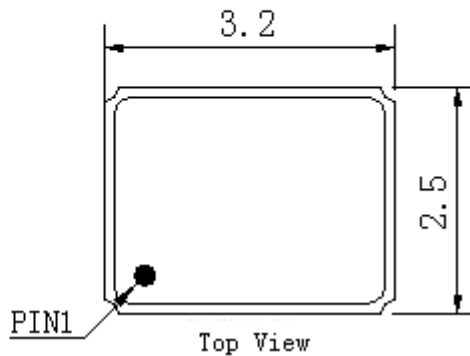

Top View

Note1: Tolerance $\pm 0.1\text{mm}$ without mark

Note2: Referential weight 0.02g

3. Test circuit

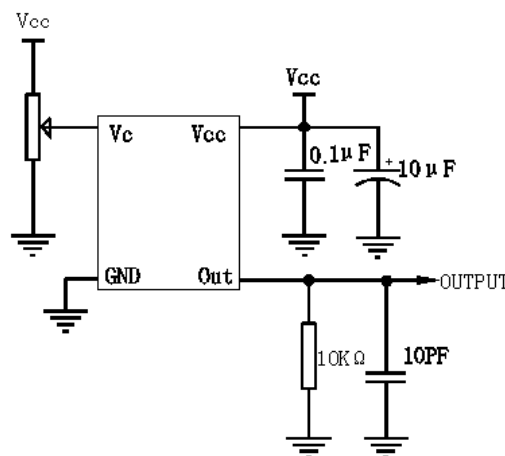



4. Reflow Soldering Curve (RoHS)



Note: If soldering with a hot air gun, ensure the temperature < 320°C , soldering time < 15 seconds.

5. Package: Tape & Reel (mm)

