

Customer Code : \_\_\_\_\_

# DATASHEET

DAPU P/N: M936-H419-50.00MHz

Customer P/N: \_\_\_\_\_

DAPU			Customer Approval
Drew	Audited	Approved	Stamp, please! Thanks!
Date: 2017.07.05			

## Guangdong Dapu Telecom Technology Co.,Ltd

Bldg13-16,.N.Ind.Zone,SSL Industry Park, Dongguan City, Guangdong Province, China

TEL: 0086-0769-88010888 FAX: 0086-0769-81800098





## 1. Electrical Parameters

MODEL: M936-H419-50.00MHz						
Item	Description	Parameters			Unit	Test Condition
		Min.	Typ.	Max.		
Output	Frequency	50.00			MHz	
	Output Waveform	Sine Wave				
	Level	5			dBm	
	Harmonics Suppression			-30	dBc	
	Spurious Suppression			-60	dBc	
	Load	50			$\Omega$	
Frequency Stabilities	Frequency Tolerance vs. Operating Temperature Range	-0.1		+0.1	$\times 10^{-6}$	$T_A$ varied from $-40^{\circ}\text{C}$ to $85^{\circ}\text{C}$ , measurement referenced to frequency observed with $T_A = 25^{\circ}\text{C}$ , $V_{cc} = 3.3\text{V}$ , $O_{load} = 50\Omega$ , temperature variable speed less than $2^{\circ}\text{C}$ per minute.
	Initial Frequency Tolerance	-0.5		+0.5	$\times 10^{-6}$	Measurement referenced to frequency observed with $T_A = 25^{\circ}\text{C}$ , $V_{cc} = 3.3\text{V}$ within 30 days after ex-works.
	Frequency Tolerance vs. Supply Voltage	-0.05		+0.05	$\times 10^{-6}$	measurement referenced to frequency observed $T_A = 25^{\circ}\text{C}$ , $V_{cc}$ varied from 3.13V to 3.47V, and $O_{Load} = 50\Omega$ .
	Frequency Tolerance vs. Load	-0.05		+0.05	$\times 10^{-6}$	5% load change measurement referenced to frequency observed with $T_A = 25^{\circ}\text{C}$ , $V_{cc} = 3.3\text{V}$ , $O_{Load} = 50\Omega$ .
	Aging Tolerance Per Day	-0.02		+0.02	$\times 10^{-6}$	$T_A = 25^{\circ}\text{C}$ , $V_{cc} = 3.3\text{V}$ , and after 1h of operation.
	Aging Tolerance 1 Year	-1		+1	$\times 10^{-6}$	
Power Supply	Current Consumption			20	mA	@ $25^{\circ}\text{C}$ , $V_{cc} = 3.3\text{V}$ , $O_{load} = 50\Omega$ .
	Supply Voltage	3.13	3.3	3.47	V	
Phase Noise	Phase Noise		-75	-70	dBc/Hz	10Hz
			-105	-100		100Hz
			-125	-120		1KHz
			-143	-138		10KHz
			-145	-140		100KHz
			-148	-143		1MHz



Environmental Conditions	Operable Temperature	-40		+85	°C	
	Storage Temperature	-55		+105	°C	
	ESD Level	Human Body Model, class2: 2000V to 4000V; ANSI/ESDA/JEDEC JS-001-2010.				
		Machine Model, class B: 200V to 400V; ANSI/ESDA/JEDEC JS-001-2010.				
	Moisture Sensitivity Level	Level 2.				
	Vibration	Test Condition: 0.75mm ;acceleration:10g;10Hz~2000Hz, one cycle per 30 min, test 2 hour. (3 times for each 3 directions X , Y , Z) .IEC 68-2-06 Test Fc.				
Shock	100g; 6ms; half sine wave (3 times for each 3 directions X , Y, Z ),IEC 68-2-27 Test Ea/Severity 50A.					
Full Package Storage	Relative humidity (%)	20% ~ 70%				
	Temperature (°C)	-10~35°C				

DAPU Confidential



## 2. Mechanical Structure(mm)

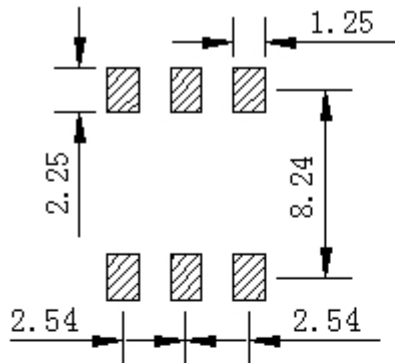

Solder Pad layout

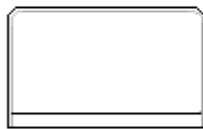

Right view

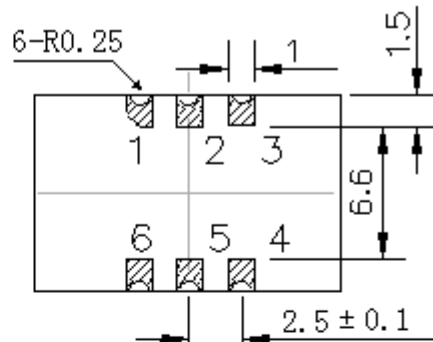

Bottom view

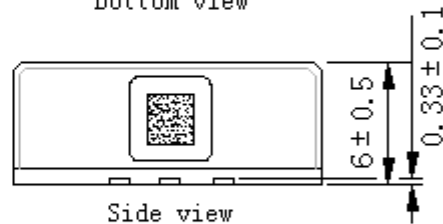

Side view

### PIN FUNCTION

PIN	NOTATION	FUNCTION
1	NC	Not Connect
2,5	NC	Not Connect
3	GND	GND
4	OUTPUT	RF Output
6	VCC	Supply Voltage

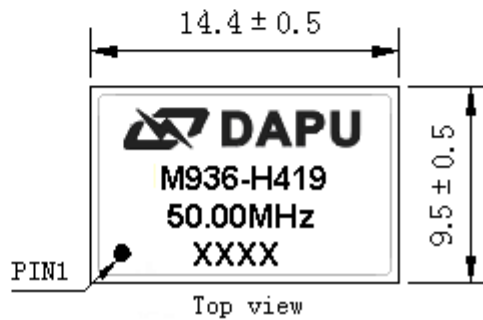

Top view

- Note1:** Tolerance  $\pm 0.20\text{mm}$  without mark
- Note2:** The first two xx representative: week  
After two xx representative: year
- Note3:** Referential weight 1.5g
- Note4:** NC is not connect

## 3. Test circuit

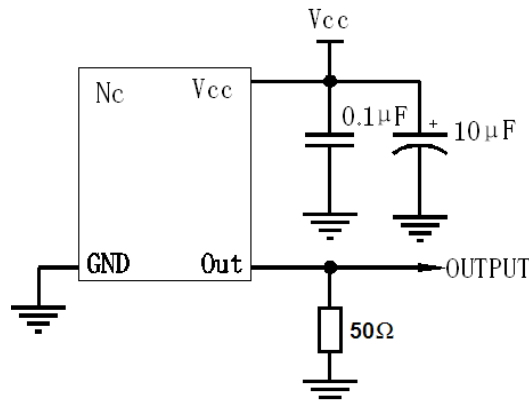



#### 4. Reflow Soldering Curve (RoHS)

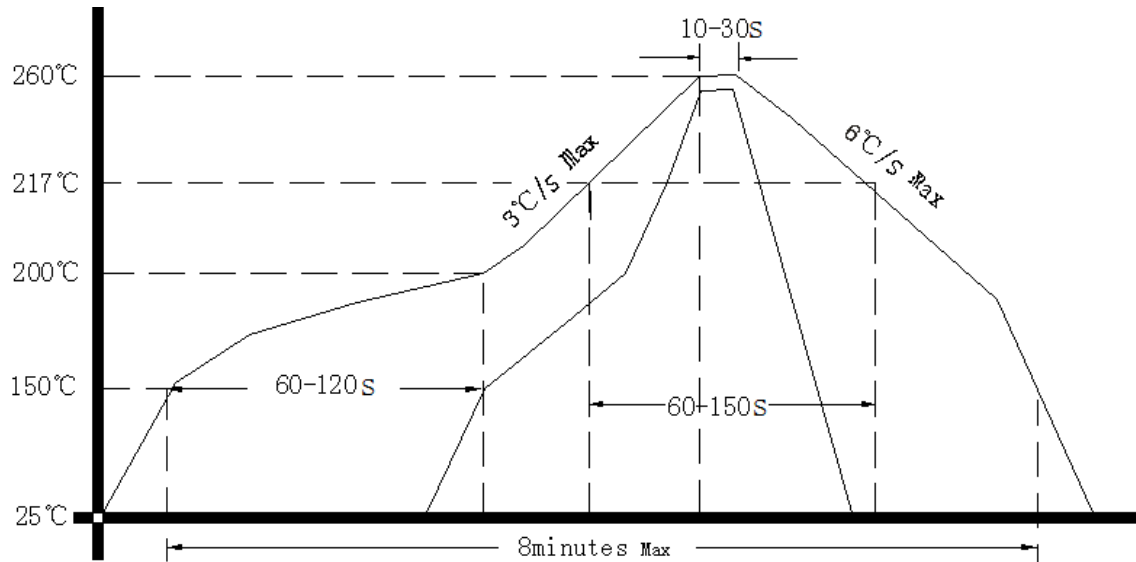

#### 5. Package: Tape & Reel (mm)

