

Customer Code : _____

DATASHEET

DAPU P/N : M75B-H413-10.00MHz

Customer P/N: _____

DAPU			Customer Approval
Drew	Audited	Approved	Stamp, please! Thanks!
<i>Amway.wei</i>	<i>Carry.Wang</i>	<i>James.Liu</i>	
Date: 2017.05.05			



Guangdong Dapu Telecom Technology Co.,Ltd

Bldg13-16,.N.Ind.Zone,SSL Industry Park, Dongguan City, Guangdong Province, China

TEL: 0086-0769-88010888 FAX: 0086-0769-81800098

**1. Electrical Parameters**

MODEL: M75B-H413-10.00MHz						
Item	Description	Parameters			Unit	Test Condition
		Min.	Typ.	Max.		
Output	Frequency	10.00			MHz	
	Output Waveform	Clipped Sine Wave				
	V _{p-p}	0.8			V	
	Load	10KΩ/10pF				
Frequency Stabilities	Frequency Tolerance vs. Operating Temperature Range	-0.1		+0.1	× 10 ⁻⁶	T _A varied from -40 to 85°C, measurement referenced to frequency observed with f _{ref} =(f _{max} +f _{min})/2, V _{cc} =3.3V, V _c =1.65V, O _{load} =10KΩ/10pF, temperature variable speed less than 2°C per minute.
	Initial Frequency Tolerance	-1		+1	× 10 ⁻⁶	Measurement referenced to frequency observed with T _A =25°C, V _{cc} =3.3V, V _c =1.65V, within 30 days after ex-works.
	Frequency Tolerance vs. Supply Voltage	-0.1		+0.1	× 10 ⁻⁶	measurement referenced to frequency observed T _A =25°C, V _{cc} varied from 3.13V to 3.47V, V _c =1.65V and O _{Load} =10KΩ/10pF.
	Frequency Tolerance vs. Load	-0.1		+0.1	× 10 ⁻⁶	5% load change measurement referenced to frequency observed with T _A =25°C, V _{cc} =3.3V, V _c =1.65V, O _{Load} =10KΩ/10pF.
	Aging Tolerance Per Day	-0.02		+0.02	× 10 ⁻⁶	T _A =25°C, V _{cc} =3.3V, V _c =1.65V, and after 1h of operation.
	Aging Tolerance 1 Year	-1		+1	× 10 ⁻⁶	
Power Supply	Current Consumption			10	mA	@25°C, V _{cc} =3.3V, O _{load} =10KΩ/10pF.
	Supply Voltage	3.13	3.3	3.47	V	
Voltage Control	Frequency tuning range	-15		-10	× 10 ⁻⁶	V _c =0V. measurement referenced to V _c =1.65V.
		-1.0		+1.0	× 10 ⁻⁶	V _c =1.65V. measurement referenced to Exactly 10.00MHz.
		+10		+15	× 10 ⁻⁶	V _c =3.3V. measurement referenced to V _c =1.65V.
	Linearity			10	%	
	Slope	Positive				
	Input Impedance	100			KΩ	



Phase Noise	Phase Noise		-90	-85	dBc/Hz	10Hz
			-115	-110		100Hz
			-135	-130		1KHz
			-145	-140		10KHz
			-150	-145		100KHz
Environmental Conditions	Operable Temperature	-40		+85	°C	
	Storage Temperature	-55		+105	°C	
	ESD Level	Human Body Model, class2: 2000V to 4000V; ANSI/ESDA/JEDEC JS-001-2010.				
		Machine Model, class B: 200V to 400V; ANSI/ESDA/JEDEC JS-001-2010.				
	Moisture Sensitivity Level	Level 2.				
	Vibration	Test Condition: 0.75mm ;acceleration:10g;10Hz~2000Hz, one cycle per 30 min, test 2 hour. (3 times for each 3 directions X , Y , Z) .IEC 68-2-06 Test Fc.				
Shock	100g; 6ms; half sine wave (3 times for each 3 directions X , Y , Z),IEC 68-2-27 Test Ea/Severity 50A.					
Full Package Storage	Relative humidity (%)	20%~70%				
	Temperature (°C)	-10~35°C				



2. Mechanical Structure(mm)

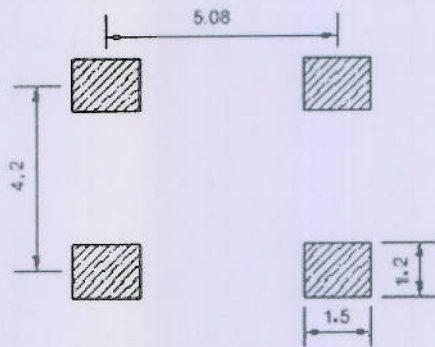

Solder pad layout

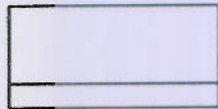

Right view

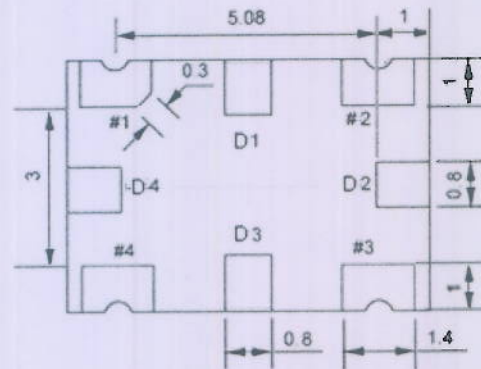

Bottom view

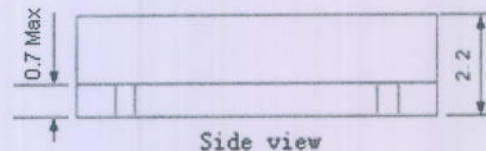

Side view

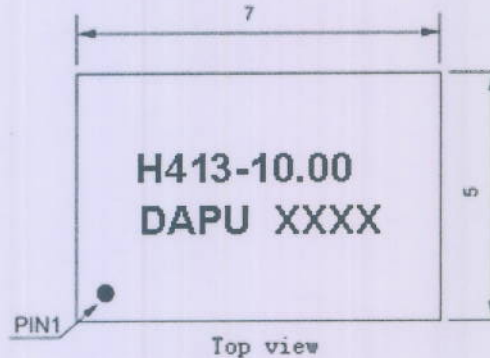

Top view

PIN FUNCTION

PIN	NOTATION	FUNCTION
D1, D2, D3, D4	NC	Not Connect
1	VC	Control Voltage
2	GND	GND
3	OUTPUT	RF Output
4	VCC	Supply Voltage

Note1: Tolerance $\pm 0.20\text{mm}$ without mark

Note2: The first two xx representative: week

After two xx representative: year

Note3: Referential weight 0.2g

Note4: NC is not connect



3. Test circuit

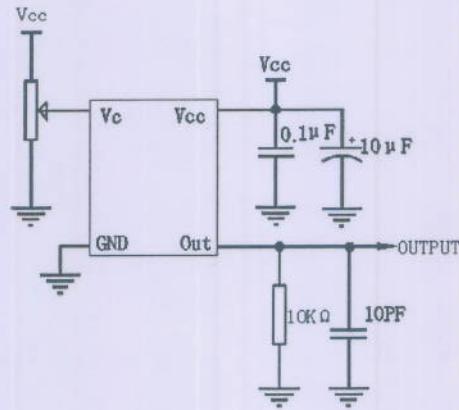

4. Reflow Soldering Curve (RoHS)

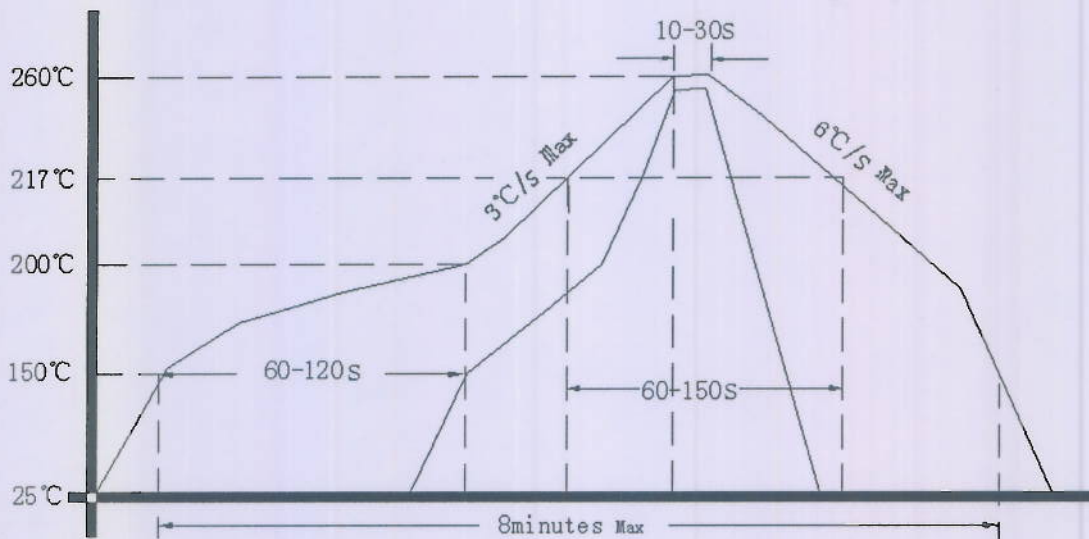

5. Package: Tape & Reel (mm)

