

Customer Code : _____

DATASHEET

DAPU P/N: **T75B-P512-50.00MHZ**

Customer P/N: _____

DAPU			Customer Approval
Drew	Audited	Approved	Stamp, please! Thanks!
Date: 2015.12.10			

Guangdong Dapu Telecom Technology Co.,Ltd

Bldg 16,.N.Ind.Zone,SSL Industry Park, Dongguan City, Guangdong Province, China

TEL: 0086-0769-88010888 FAX: 0086-0769-81800098



1. Electrical Parameters

MODEL: T75B-P512-50.00MHz						
Item	Description	Parameters			Unit	Test Condition
		Min.	Typ.	Max.		
Output	Frequency	50.00			MHz	
	Output Waveform	Clipped Sine Wave				
	Vp-p	0.6			V	
	Load	10KΩ//10pF				
Frequency Stabilities	Frequency Tolerance vs. Operating Temperature Range	-0.28		+0.28	$\times 10^{-6}$	T_A varied from -40°C to 85°C , measurement referenced to frequency observed with $f_{\text{ref}}=(f_{\text{max}}+f_{\text{min}})/2$, $V_{\text{cc}}=3.3\text{V}$, $V_c=1.65\text{V}$, $O_{\text{load}}=10\text{K}\Omega//10\text{pF}$, temperature variable speed less than 2°C per minute.
	Initial Frequency Tolerance	-1		+1	$\times 10^{-6}$	Measurement referenced to frequency observed with $T_A=25^{\circ}\text{C}$, $V_{\text{cc}}=3.3\text{V}$, $V_c=1.65\text{V}$ within 30 days after ex-works.
	Frequency Tolerance vs. Supply Voltage	-0.1		+0.1	$\times 10^{-6}$	measurement referenced to frequency observed $T_A=25^{\circ}\text{C}$, V_{cc} varied from 3.13V to 3.47V, $V_c=1.65\text{V}$ and $O_{\text{Load}}=10\text{K}\Omega//10\text{pF}$.
	Frequency Tolerance vs. Load	-0.1		+0.1	$\times 10^{-6}$	5% load change measurement referenced to frequency observed with $T_A=25^{\circ}\text{C}$, $V_{\text{cc}}=3.3\text{V}$, $V_c=1.65\text{V}$ and $O_{\text{Load}}=10\text{K}\Omega//10\text{pF}$.
	Aging Tolerance Per Day	-0.02		+0.02	$\times 10^{-6}$	$T_A=25^{\circ}\text{C}$, $V_{\text{cc}}=3.3\text{V}$, $V_c=1.65\text{V}$ and after 1h of operation.
	Aging Tolerance 1 Year	-1		+1	$\times 10^{-6}$	
Power Supply	Operating Current			10	mA	@ 25°C , $V_{\text{cc}}=3.3\text{V}$, $V_c=1.65\text{V}$, $O_{\text{Load}}=10\text{K}\Omega//10\text{pF}$.
	Supply Voltage	3.13	3.3	3.47	V	



Voltage Control	Frequency tuning range			-5	$\times 10^{-6}$	$V_c=0V$. measurement referenced to $V_c=1.65V$.
		-1		+1	$\times 10^{-6}$	$V_c=1.65V$. measurement referenced to Exactly 50.00MHz.
		+5			$\times 10^{-6}$	$V_c=3.3V$. measurement referenced to $V_c=1.65V$.
	Linearity			10	%	
	Slope	Positive				
	Input Impedance	100				K Ω
Phase Noise	Phase Noise @25°C		-125	-120	dBc/Hz	1KHz
Environmental Conditions	Operable Temperature	-40		+85	°C	
	Storage Temperature	-55		+105	°C	
	ESD Level	Human Body Model,class2: 2000V to 4000V; ANSI/ESDA/JEDEC JS-001-2010.				
		Machine Model, class B: 200V to 400V; ANSI/ESDA/JEDEC JS-001-2010.				
	Moisture Sensitivity Level	Level 2.				
	Vibration	Test Condition: 0.75mm ;acceleration:10g;10Hz~2000Hz, one cycle per 30 min, test 2 hour. (3 times for each 3 directions X , Y , Z) .IEC 68-2-06 Test Fc.				
Shock	100g; 6ms; half sine wave (3 times for each 3 directions X , Y , Z),IEC 68-2-27 Test Ea/Severity 50A.					
Full Package Storage	Relative humidity (%)	20%~70%				
	Temperature (°C)	-10~35°C				



2. Mechanical Structure(mm)

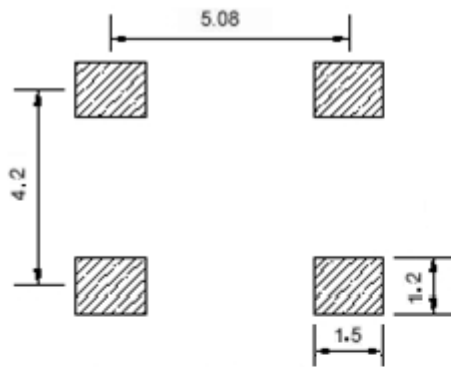

Solder pad layout

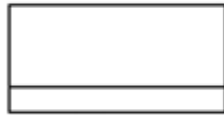

Right view

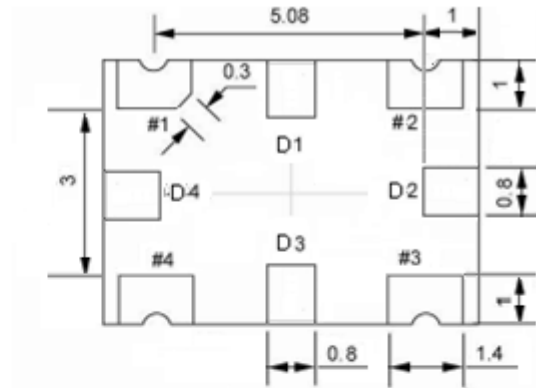

Bottom view

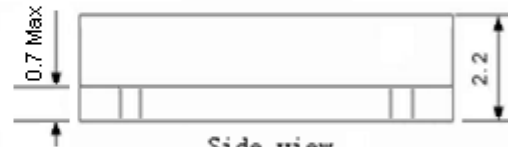

Side view

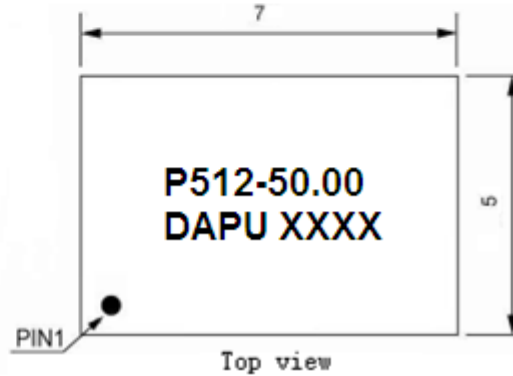

Top view

PIN FUNCTION

PIN	NOTATION	FUNCTION
D1, D2, D3, D4	NC	Not Connect
1	VC	Control Voltage
2	GND	GND
3	OUTPUT	RF Output
4	VCC	Supply Voltage

Note1: Tolerance $\pm 0.20\text{mm}$ without mark

Note2: The first two xx representative: week

After two xx representative: year

Note3: Referential Weight 0.2g

Note4: NC is not connect



3. Test Circuit

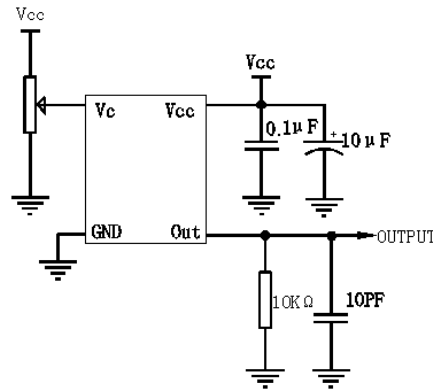

4. Reflow Soldering Curve (RoHS)

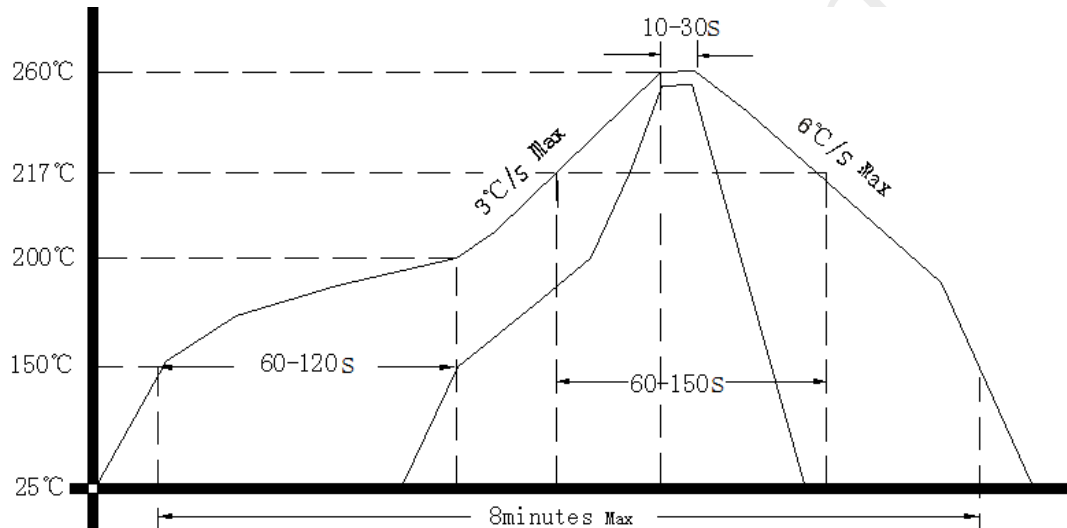

Note: If soldering with a hot air gun, ensure the temperature < 320°C , soldering time < 15 seconds.

5. Package: Tape & Reel (mm)

