

**Table of amendment**

Version	Revision contents	Prepared by	Revised date
1.0	The first issued	<i>Amway</i>	2015.01.12
1.1	“Unit”, “Initial Frequency Tolerance” changed	<i>Amway</i>	2015.01.14
1.2	Modified according to customer requirements: 1. “Aging Tolerance 1 Year” added 2. “Frequency Tolerance vs. Operating Temperature Range”, “Allan Deviation”, “Aging Tolerance Per Day”, “Current Consumption”, “Warm-up completion time”, “Warm up current”, “3.1.2 EEPROM for inventory and data storage”, “3.1.4 Temperature stability correction record in EEPROM”, “3. I ² C Devices Address -Notes”, “3.2. Temperature sensor” changed 3. “Warm-up stability”, “Frequency variation During Thermal Shock”, “Maximum daily ageing phase variation, based on mean ageing slope linear estimation over 48h” deleted	<i>Amway</i>	2015.01.28
1.3	“Initial Frequency Tolerance” and “3.2. DIGITAL THERMOMETER- Device address” changed	<i>Amway</i>	2015.01.29
1.4	1. Modified the 1 st page 2. Modified according to customer requirements: “Warm-up completion time - Test Condition”, “3.1.3 Inventory record in EEPROM -Function Code”, “3. I ² C Devices Address-Note 10-conversion formula ”changed “Internal temperature” instead of “Ambient Temperature” 3. “3.2. DIGITAL THERMOMETER- Device name”, “3. I ² C Devices Address-Note 7” corrected	<i>Amway</i>	2015.03.16
1.5	Modified according to customer requirements: Warm-up stability	<i>Amway</i>	2015.04.13
1.6	1. “Environmental Reliability(Air temperature)-High-Low Temp” change to “Environmental Reliability (Air temperature)- High-High Temp” 2. “Warm-up stability- Test Condition” changed	<i>Amway</i>	2015.04.16
1.7	“3.1.4 Temperature stability correction record in EEPROM” changed	<i>Amway</i>	2015.07.29
1.8	Modified according to customer requirements: “3.1.4 Temperature stability correction record in EEPROM”	<i>Amway</i>	2015.07.31



1. Electrical Parameters

MODEL: O22S-2103-10.00MHz							
Item	Description	Parameters			Unit	Test Condition	
		Min.	Typ.	Max.			
Output	Frequency	10.00			MHz		
	Output Waveform	LVTTL					
	Output Low Voltage			0.4	V	$V_{cc}=5.0V, O_{load}=15pF$	
	Output High Voltage	2.4			V	$V_{cc}=5.0V, O_{load}=15pF$	
	Duty Cycle	45	50	55	%	@50%	
	Rise / Fall Time (10%~90%)		2	3	ns	@25°C	
	Load	15			pF		
	Frequency Tolerance vs. Operating Temperature Range		-3		+3	ppb	T_A varied from -5°C to 85°C, measurement referenced to frequency observed with $f_{ref}=(f_{max}+f_{min})/2$ $V_{cc}=5.0V, O_{load}=15pF$, temperature variable speed less than 1°C per minute.
			-0.3		+0.3	ppb	$\Delta T < 5^\circ C$ within range -5°C to 85°C $V_{cc}=5.0V, O_{load}=15pF$, temperature variable speed less than 1°C per minute.
			-0.3		+0.3	ppb	Frequency variation after thermal Correction within range -5°C to 85°C $V_{cc}=5.0V, O_{load}=15pF$, temperature variable speed less than 1°C per minute.
	Initial Frequency Tolerance	-100		+100	ppb	$T_A=25^\circ C, V_{cc}=5.0V$, at shipment measurement referenced to 10MHz after 10 minutes of warm-up .	
	Warm-up stability	-15		+15	ppb	Y(unit: s) is the time needed from start up to steady status(refer to frequency test 1 hour after start-up). B(unit:°C) is internal temperature. Formula to calculate Y at different temperature point (ambient temperature range: -7°C~85°C) is: $Y = -1.2 \times B + 235$.	
Allan Deviation			0.01	ppb	Temperature stability, no EMI\EMC or other interference, test after power for 24hours, 25°C; 1s, using PN9000 equipment.		
			0.015	ppb	Temperature stability, no EMI\EMC or other interference, test after power for 24hours, 25°C; 10s, using PN9000 equipment.		



				0.05	ppb	Temperature stability, no EMI/EMC or other interference, test after power for 24hours, 25°C; 100s, using PN9000 equipment.
	Maximum total frequency jump	-0.2		+0.2	ppb	Test the frequency every 2s after the products are powered off for 72 hours. Take 10 frequency values and calculate the average value.
	Aging Tolerance Per Day	-0.5		+0.5	ppb	V_{cc} , T_A constant measurement referenced to frequency observed with $T_A=25^\circ\text{C}$, $V_{cc}=5.0\text{V}$ and after 30 days of operation.
	Aging Tolerance 1 Year	-100		+100	ppb	
	Overall Stability	-500		+500	ppb	Inclusive of the following: operating temperature -5°C to 85°C $5.0\text{V}\pm 5\%$ 15pF load $\pm 5\%$ 10 years aging reference to nominal frequency
Power Supply	Supply Voltage	4.9	5.0	5.1	V	
	Current Consumption			800	mA	$T_A=-5^\circ\text{C}$
				300	mA	$T_A=25^\circ\text{C}$
				200	mA	$T_A=85^\circ\text{C}$
	Warm-up completion time			10	min	$T_A=25^\circ\text{C}$, Oscillator frequency within $\pm 0.015 \times 10^{-6}$, with reference to 24 hour value .
	Warm up current			800	mA	
	Ripple noise on power supply			10	mV	Peak to peak
Inrush current on the 5V supply, at power up			3500	mA	For a 50 μs max	
Phase Noise	Phase Noise @25°C			-80	dBc/Hz	1Hz
				-100		10Hz
				-120		100Hz
				-130		1KHz
				-130		10KHz
				-130		1MHz



Environmental Conditions	Reference Air Velocity	1	2	3	m/s	
	Operable Temperature	-5		+85	°C	
	Storage Temperature	-40		+85	°C	
	ESD Level	Human Body Model, class2: 2000V to 4000V; ANSI/ESDA/JEDEC JS-001-2010.				
		Machine Model, class B: 200V to 400V; ANSI/ESDA/JEDEC JS-001-2010.				
Moisture Sensitivity Level	Level 2 .					
Environmental Reliability (Operational Conditions)	Vibration(Sinusoidal)	1. Frequency range:5-9Hz (displacement: 1,2mm) 2. Frequency range:9-200Hz (displacement: 4m/s ²) 3. Duration:3×5 sweep cycles				
	Vibration(Random)	1. Frequency range:5-10Hz,10-50Hz,50-100Hz 2. ASD:0,04m ² /s ³ 3. Duration:3 × 30 minutes				
	Shocks	1. Shock spectrum: half sine 2. Duration:11ms 3. Acceleration:50m/s ² 4. Directions of bumps:6 5. Duration:100 in each direction				
	Humidity	1. Temperature:30°C 2. Humidity: 93%RH 3. Duration: 4d (96h)				
Environmental Reliability (Non Operational Conditions)	Random Vibration	1. Frequency range:5-20Hz,20-200Hz. 2. ASD:1 m ² /s ³ 3. Duration:3 × 30 minutes				
	Shocks	1. Shock spectrum: half sine 2. Duration:6ms 3. Acceleration:180m/s ² 4. Directions of bumps:6 5. Duration:100 in each direction				
	Free fall	1. Height:0.1m 2. Duration:1 fall on each face				
Environmental Reliability (Air temperature)	Low	1. Low Temp:-25°C ; 2. Duration: 72h				
	High	1. High Temp:70°C ; 2. Duration: 72h				
	air/air Change	1. Temp Change:-25°C ~30°C 2. Cycle:5				



	Humidity	1. Temperature:30°C 2. Humidity: 93%RH 3. Duration: 4d (96h)
	Humidity (Condensation)	1. Temperature:30°C 2. Humidity: 90-100%RH 3. Duration: 2Cycle
Full Package Storage	Relative humidity (%)	20%~70%
	Temperature (°C)	-10~35°C

DAPU Confidential



2. Mechanical Structure(mm)

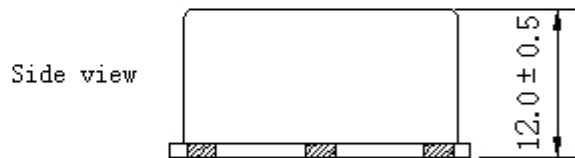
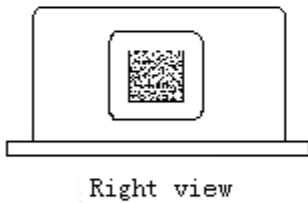
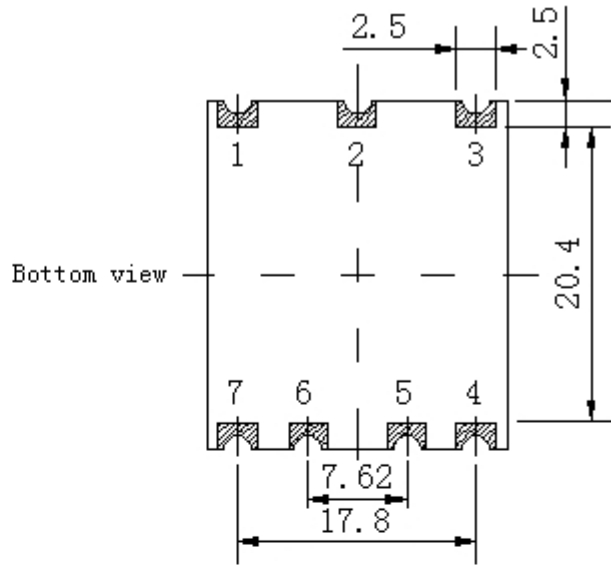
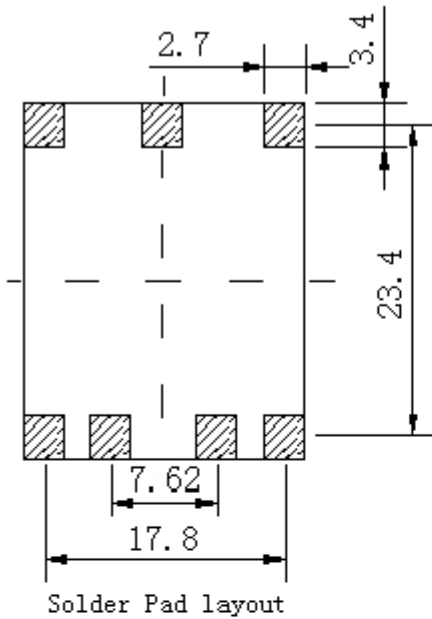

PIN FUNCTION

PIN	NOTATION	FUNCTION
1,2	NC	Not Connect
3	VCC	Supply Voltage
4	OUTPUT	RF Output
5	SCL	Serial Clock Input
6	SDA	Serial Data Input/Output
7	GND	GND

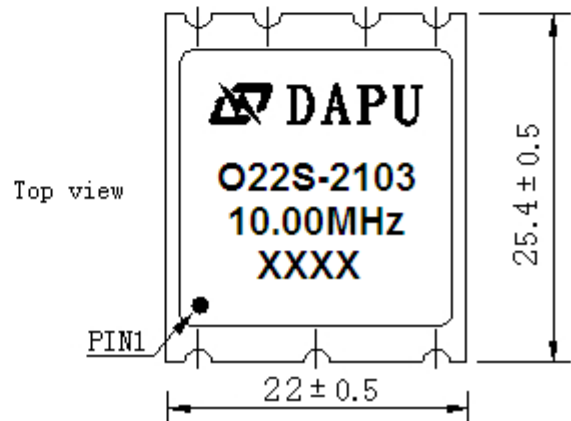

Note1: Tolerance ± 0.2 mm without mark

Note2: The first two xx representative: week
After two xx representative: year

Note3: Referential Weight 12 g

Note4: NC is not connect

Note5: Material composition :

Pad/terminals: Cu (Surface plating: Ni 3-6um, Au 0.1~0.5um)

Base: High-TG FR4

Cover: Stainless steel



3. I²C Devices Address

3.1.1 8K I²C SERIAL EEPROM

Device name : AT24C08C

Device supplier : Atmel

Device address : 1010100~1010111

3.1.2 EEPROM for inventory and data storage

Address	Total number of bytes	Usage
0x000 – 0x05F	96	Inventory record
0x060 – 0x07F	32	Reserved future inventory format extension
0x080 – 0x1FF	384	Temperature stability correction record
0x0200 – 0x2FF	256	Reserved for aging correction record
0x0300 – 0x3FF	256	Reserved for future use

3.1.3 Inventory record in EEPROM

The inventory record inside the EEPROM will be in the following format. This is a 96 byte format.

Identification Fields	D#	# of bytes	Values (in Hex)
Header	D0	1	80
Function Code: OCSD2	D1-D11	11	5 ASCII bytes to show “OCSD2” See note 1 for unused position filling
Serial Number: “Y ₁ Y ₀ F ₁ F ₀ M ₁ M ₀ N ₅ N ₄ N ₃ N ₂ N ₁ N ₀ ” Y ₁ Y ₀ =year,F ₁ F ₀ =factory code, M ₁ M ₀ =month N ₅ N ₄ N ₃ N ₂ N ₁ N ₀ =unit number	D12-D24	13	Variable Note 1,2, 4
Doc Number	D25-D36	12	9 ASCII bytes to show “DD/045622” See note 1 for unused position filling
Doc Issue No. "I ₁ -I ₀ " (e.g. 1.8)	D37-D41	5	Note 1,6
Version “SS ₂ :S ₁ S ₀ ” (eg. S4:00)	D42-D47	6	Note 1,4
Supplier’s Part Number : numbering scheme (12-digit)	D48-D62	15	12 ASCII bytes See note 1 for unused position filling See note 5 for value
Supplier Specific Information (If applicable)	D63-D73	11	Note 1
Specific information per function code	D74-D80	7	Note 1, 3
Supplier Code (Supplier’s company name in capital letter)	D81-D94	14	“DAPU” See note 1 for unused position filling
End of File	D95	1	04



3.1.4 Temperature stability correction record in EEPROM

In the EEPROM, record frequency-temperature slope by using below format. This is a 4 byte format.

Identification Fields	D#	# of bytes	Values (in Hex)
Frequency-Temperature Slope	0x80 – 0x83	4	Note 7,8

Notes

- The I/D values are in ASCII representation except where explicitly noted. Unused positions in a field are filled with the ASCII space character (20h). A null character (00h) is in the last byte of each field, except header and End-of-file. The end-of-file ASCII character (04h) indicates end of inventory data.
- The variable values will be provided by or agreed to by SCN contact for use here.
- This field is reserved for future use.
- F1F0 is defined by Supplier to identify different factory of the Supplier to manufacture the part. SS2:S1S0 is defined by Supplier to differentiate different version of the part. Every Hardware or software modification must be identified by a new value.
- This part number is specific to each supplier, and must clearly identify the product. Different values must be used before and after qualification.
- The Doc Issue in inventory is the version used by supplier to design product.
- Use IEEE754 as the storage mode:

Example

The Slope represent the frequency changes varies on the basis of the internal temperature sensor(NTC75).

Slope= -0.25ppb/°C

Decimal Representation

-0.25

Binary Representation

-0.01= -1.0*2⁻²

Calculate the exponent

-2+127=125

Sign	Exponent	Mantissa
1	01111101	000000000000000000000000

Store the data of address into EEPROM

Address	0x83	0x82	0x81	0x80
Data	0x BE	0x 80	0x 00	0x 00

- The formula which reflects correspondence between ambient temperature and the detected internal temperature is as below(This value is only typical, each temperature spot has about ±5°C error):

$$Y=0.16 \times B+76$$

B is ambient temperature; Y is the corresponding internal temperature.

3.2. DIGITAL THERMOMETER

Device name: NCT75

Device supplier: ON Semiconductor



Device address: 1001001

Note: More detailed information see the datasheet provide by the ONSEMI.

4. Test Circuit

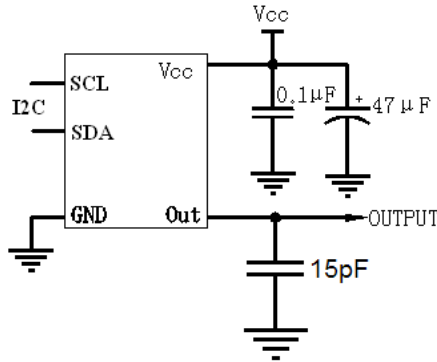

5. Reflow Soldering Curve (RoHS)

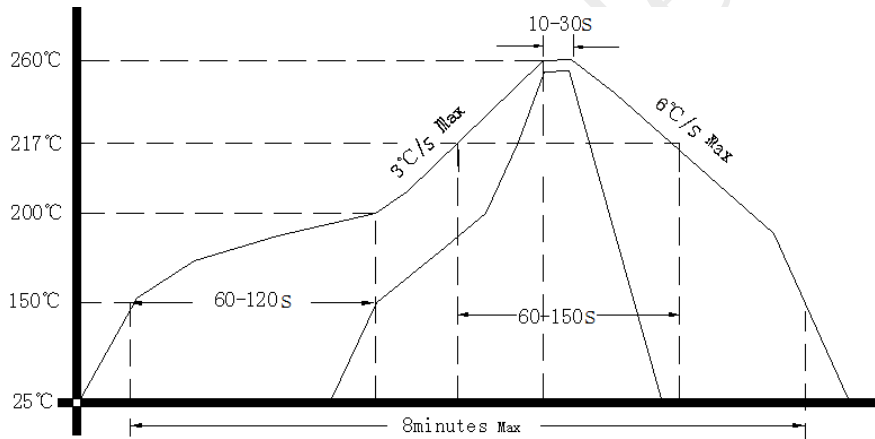

6. Package(mm)

