

Travelling Merchant: _____

DATASHEET

Standard: **T75B-F319-40.00MHz**

P/N: _____

Plot			The Label
Drew	Audited	Approved	Stamp, please! Thanks!
Date: 2013.12.25			

Guangdong Dapu Telecom Technology Co.,Ltd

Bldg13-16,.N.Ind.Zone,SSL Industry Park, Dongguan City, Guangdong Province, China

TEL: 0086-0769-88010888 FAX: 0086-0769-81800098



1. Electrical Parameters

MODEL: T75B-F319-40.00MHz						
Item	Description	Parameters			Unit	Test Condition
		Min.	Typ.	Max.		
Output	Frequency	40.00			MHz	
	Output Waveform	HCMOS				
	Output Low Voltage			0.4	V	$V_{cc}=3.3V, O_{load}=15\text{ pF}$
	Output High Voltage	2.4			V	$V_{cc}=3.3V, O_{load}=15\text{ pF}$
	Duty Cycle	45	50	55	%	@50%
	Rise / Fall Time (10%~90%)			8	ns	@25°C
	Load	15			pF	
Frequency Stabilities	Frequency Tolerance vs. Operating Temperature Range	-0.5		+0.5	$\times 10^{-6}$	T_A varied from -40°C to 85°C, measurement referenced to frequency observed with $T_A = 25^\circ\text{C}$, $V_{cc}=3.3V$, $O_{load}=15\text{ pF}$, temperature variable speed less than 2°C per minute.
	Initial Frequency Tolerance	-1		+1	$\times 10^{-6}$	Measurement referenced to frequency observed with $T_A=25^\circ\text{C}$, $V_{cc}=3.3V$ within 30 days after ex-works.
	Frequency Tolerance vs. Supply Voltage	-0.2		+0.2	$\times 10^{-6}$	measurement referenced to frequency observed $T_A=25^\circ\text{C}$, V_{cc} varied from 3.13V to 3.47V, and $O_{Load}=15\text{ pF}$.
	Frequency Tolerance vs. Load	-0.2		+0.2	$\times 10^{-6}$	5% load change measurement referenced to frequency observed with $T_A=25^\circ\text{C}$, $V_{cc}=3.3V$, $O_{Load}=15\text{ pF}$.
	Aging Tolerance Per Day	-0.02		+0.02	$\times 10^{-6}$	$T_A=25^\circ\text{C}$, $V_{cc}=3.3V$, and after 1h of operation.
	Aging Tolerance 1 Year	-1		+1	$\times 10^{-6}$	
Power Supply	Current Consumption			10	mA	@25°C, $V_{cc}=3.3V$, $O_{Load}=15\text{ pF}$.
	Supply Voltage	3.13	3.3	3.47	V	



3. Test circuit

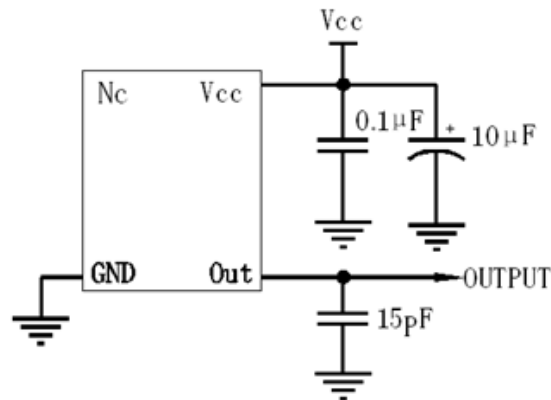

4. Reflow Soldering Curve (RoHS)

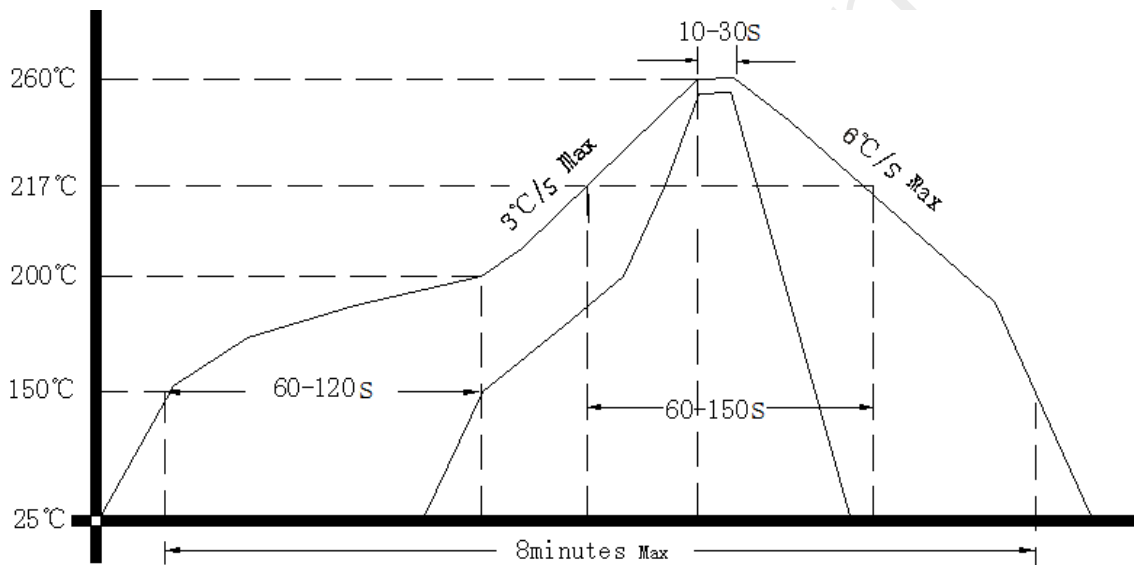

5. Package: Tape & Reel (mm)

