

Travelling Merchant: _____

DATASHEET

Standard: **O11F-Q411-38.88MHz**

P/N: _____

Plot			The Label
Drew	Audited	Approved	Stamp, please! Thanks!
Date: 2014.05.29			

Guangdong Dapu Telecom Technology Co.,Ltd

Bldg13-16,.N.Ind.Zone,SSL Industry Park, Dongguan City, Guangdong Province, China

TEL: 0086-0769-88010888 FAX: 0086-0769-81800098



1. Electrical Parameters

MODEL: O11F-Q411-38.88MHz						
Item	Description	Parameters			Unit	Test Condition
		Min.	Typ.	Max.		
Output	Frequency	38.88			MHz	
	Output Waveform	Sine wave				
	Level	6		10	dBm	
	Load	50			Ω	
	Harmonics Suppression			-30	dBc	
	Spurious Suppression			-60	dBc	
Frequency Stabilities	Frequency Tolerance vs. Operating Temperature Range	-0.02		+0.02	$\times 10^{-6}$	T_A varied from -40°C to 85°C , measurement referenced to frequency observed with $f_{\text{ref}}=(f_{\text{max}}+f_{\text{min}})/2$, $V_{\text{cc}}=3.3\text{V}$, $V_c=1.65\text{V}$, $O_{\text{load}}=50\Omega$, temperature variable speed less than 2°C per minute.
	Initial Frequency Tolerance	-0.5		+0.5	$\times 10^{-6}$	Measurement referenced to frequency observed with $T_A=25^\circ\text{C}$, $V_{\text{cc}}=3.3\text{V}$, $V_c=1.65\text{V}$ and after 15 minutes of operation, within 30 days after ex-works.
	Frequency Tolerance vs. supply voltage	-0.01		+0.01	$\times 10^{-6}$	measurement referenced to frequency observed $T_A=25^\circ\text{C}$, V_{cc} varied from 3.13V to 3.47V, $V_c=1.65\text{V}$, $O_{\text{load}}=50\Omega$.
	Frequency Tolerance vs. Load	-0.01		+0.01	$\times 10^{-6}$	5% Load Change Measurement referenced to frequency observed with $T_A=25^\circ\text{C}$, $V_{\text{cc}}=3.3\text{V}$, $V_c=1.65\text{V}$, $O_{\text{load}}=50\Omega$.
	Short Term Stability			0.1	$\times 10^{-9}$	Temperature stability, no EMI\EMC or other interference, test after power for 1hour ref. to 25°C ; 1s, using PN9000 equipment.
	Aging Tolerance per day	-5		+5	$\times 10^{-9}$	V_{cc}, V_c, T_A constant Measurement referenced to frequency observed with $T_A=25^\circ\text{C}$, $V_{\text{cc}}=3.3\text{V}$, $V_c=1.65\text{V}$, $O_{\text{load}}=50\Omega$ and after 30 days of operation.
	Aging Tolerance 1Year	-0.5		+0.5	$\times 10^{-6}$	
Power Supply	Supply Voltage	3.13	3.3	3.47	V	
	Current Consumption			250	mA	@ 25°C
	Current Consumption during warm up			560	mA	



Voltage Control Characteristics	Frequency Tuning Range	-8		-3	$\times 10^{-6}$	$V_c=0V$. measurement referenced to $V_c=1.65V$.
		-0.5		+0.5	$\times 10^{-6}$	$V_c=1.65V$. measurement referenced to exactly 38.88MHz.
		+3		+8	$\times 10^{-6}$	$V_c=3.3V$. measurement referenced to $V_c=1.65V$.
	Linearity			10	%	
	Slope	Positive				
	Input Impedance	100				K Ω
Phase Noise	Phase Noise @25°C		-100	-90	dBc/Hz	10Hz
			-130	-120		100Hz
			-145	-140		1KHz
			-150	-145		10KHz
			-150	-145		100KHz
			-155	-150		1MHz
Environmental Conditions	Operable Temperature	-40		+85	°C	
	Storage Temperature	-55		+105	°C	
	ESD Level	Human Body Model, class2: 2000V to 4000V; ANSI/ESDA/JEDEC JS-001-2010.				
		Machine Model, class B: 200V to 400V; ANSI/ESDA/JEDEC JS-001-2010.				
	Moisture Sensitivity Level	Level 2.				
	Vibration	Test Condition: 0.75mm ;acceleration:10g;10Hz~500Hz, one cycle per 30 min, test 2 hour. (3 times for each 3 directions X ,Y , Z), IEC 68-2-06 Test Fc.				
Shock	50g; 11ms; half sine wave (3 times for each 3 directions X ,Y, Z),IEC 68-2-27 Test Ea/Severity 50A.					



2. Mechanical Structure (mm)

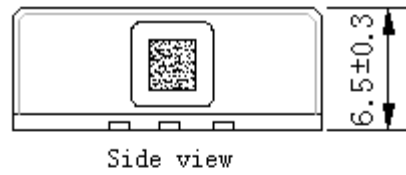
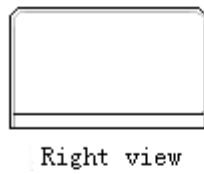
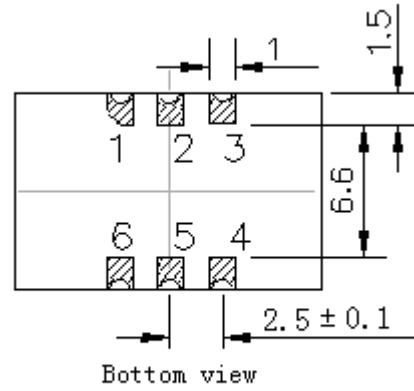
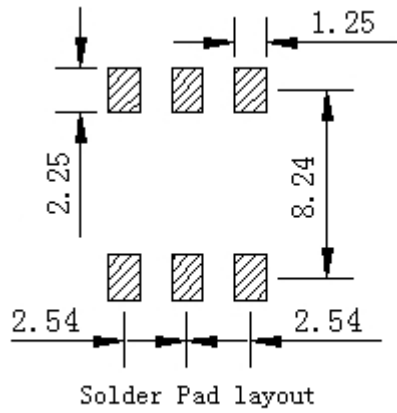

PIN FUNCTION

PIN	FUNCTION
1	VC
2,5	NC
3	GND
4	OUTPUT
6	VCC

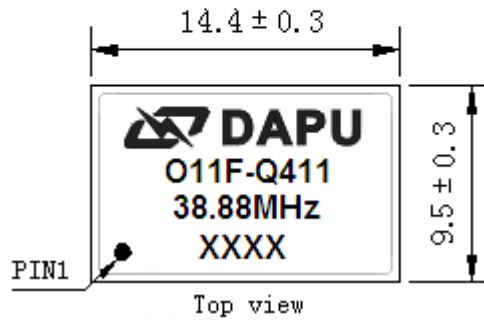

- Note1:** Tolerance $\pm 0.2\text{mm}$ without mark
Note2: The first two xx representative: week
 After two xx representative: year
Note3: Referential Weight 1.5g
Note4: NC is not connect



3. Test Circuit

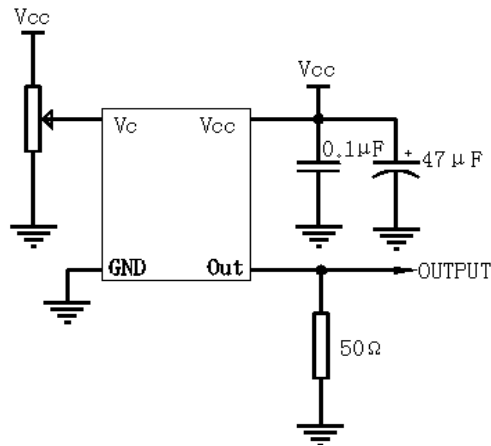

4. Reflow Soldering Curve (RoHS)

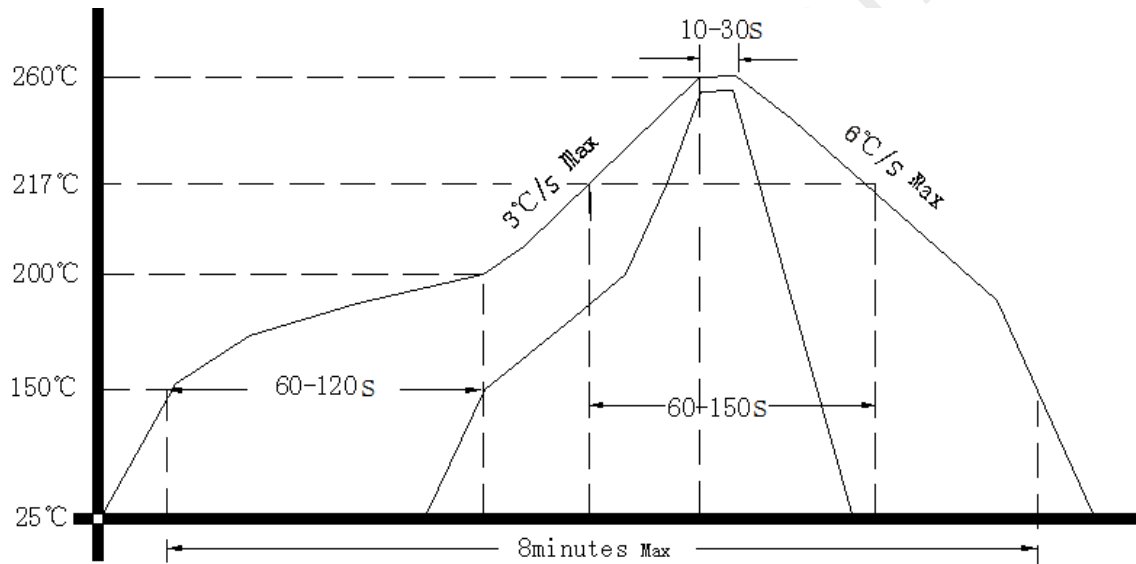

5. Package: Tape & Reel (mm)

