

Travelling Merchant: _____

DATASHEET

Standard: **M75B-P513-20.00MHz**

P/N: _____

Plot			The Label
Drew	Audited	Approved	Stamp, please! Thanks!
Date: 2014.05.28			

Guangdong Dapu Telecom Technology Co.,Ltd

Bldg13-16,.N.Ind.Zone,SSL Industry Park, Dongguan City, Guangdong Province, China

TEL: 0086-0769-88010888 FAX: 0086-0769-81800098



1. Electrical Parameters

MODEL: M75B-P513-20.00MHz						
Item	Description	Parameters			Unit	Test Condition
		Min.	Typ.	Max.		
Output	Frequency	20.00			MHz	
	Output Waveform	Clipped Sine Wave				
	Vp-p	0.8			V	
	Load	10KΩ//10pF				
Frequency Stabilities	Frequency Tolerance vs. Operating Temperature Range	-0.14		+0.14	$\times 10^{-6}$	T_A varied from -40°C to 85°C , measurement referenced to frequency observed with $T_A=25^{\circ}\text{C}$, $V_{cc}=3.3\text{V}$, $V_c=1.65\text{V}$, $O_{load}=10\text{K}\Omega//10\text{pF}$, temperature variable speed less than 2°C per minute.
	Nominal Frequency Tolerance	-0.5		+0.5	$\times 10^{-6}$	Measurement referenced to frequency observed with $T_A=25^{\circ}\text{C}$, $V_{cc}=3.3\text{V}$, $V_c=1.65\text{V}$ within 30 days after ex-works.
	Frequency Tolerance vs. Supply Voltage	-0.1		+0.1	$\times 10^{-6}$	measurement referenced to frequency observed $T_A=25^{\circ}\text{C}$, V_{cc} varied from 3.13V to 3.47V, $V_c=1.65\text{V}$ and $O_{Load}=10\text{K}\Omega//10\text{pF}$.
	Frequency Tolerance vs. Load	-0.1		+0.1	$\times 10^{-6}$	5% load change measurement referenced to frequency observed with $T_A=25^{\circ}\text{C}$, $V_{cc}=3.3\text{V}$, $V_c=1.65\text{V}$ and $O_{Load}=10\text{K}\Omega//10\text{pF}$.
	Aging Tolerance Per Day	-0.02		+0.02	$\times 10^{-6}$	$T_A=25^{\circ}\text{C}$, $V_{cc}=3.3\text{V}$, $V_c=1.65\text{V}$ and after 1h of operation.
	Aging Tolerance 1 Year	-1		+1	$\times 10^{-6}$	
Power Supply	Operating Current			10	mA	@ 25°C , $V_{cc}=3.3\text{V}$, $V_c=1.65\text{V}$, $O_{Load}=10\text{K}\Omega//10\text{pF}$.
	Supply Voltage	3.13	3.3	3.47	V	



Voltage Control	Frequency tuning range	-15		-10	$\times 10^{-6}$	$V_c=0V$. measurement referenced to $V_c=1.65V$.
		-0.5		+0.5	$\times 10^{-6}$	$V_c=1.65V$. measurement referenced to Exactly 20.00MHz.
		+10		+15	$\times 10^{-6}$	$V_c=3.3V$. measurement referenced to $V_c=1.65V$.
	Linearity			10	%	
	Slope	Positive				
	Input Impedance	100				K Ω
Phase Noise	Phase Noise @25°C		-85	-80	dBc/Hz	10Hz
			-115	-110		100Hz
			-135	-130		1KHz
			-145	-140		10KHz
			-145	-140		100KHz
			-148	-143		1MHz
Environmental Conditions	Operable Temperature	-40		+85	°C	
	Storage Temperature	-55		+105	°C	
	ESD Level	Human Body Model,class2: 2000V to 4000V; ANSI/ESDA/JEDEC JS-001-2010.				
		Machine Model, class B: 200V to 400V; ANSI/ESDA/JEDEC JS-001-2010.				
	Moisture Sensitivity Level	Level 2.				
	Vibration	Test Condition: 0.75mm ;acceleration:10g;10Hz~2000Hz, one cycle per 30 min, test 2 hour. (3 times for each 3 directions X ,Y , Z) .IEC 68-2-06 Test Fc.				
Shock	100g; 6ms; half sine wave (3 times for each 3 directions X ,Y , Z),IEC 68-2-27 Test Ea/Severity 50A.					



2. Mechanical Structure(mm)

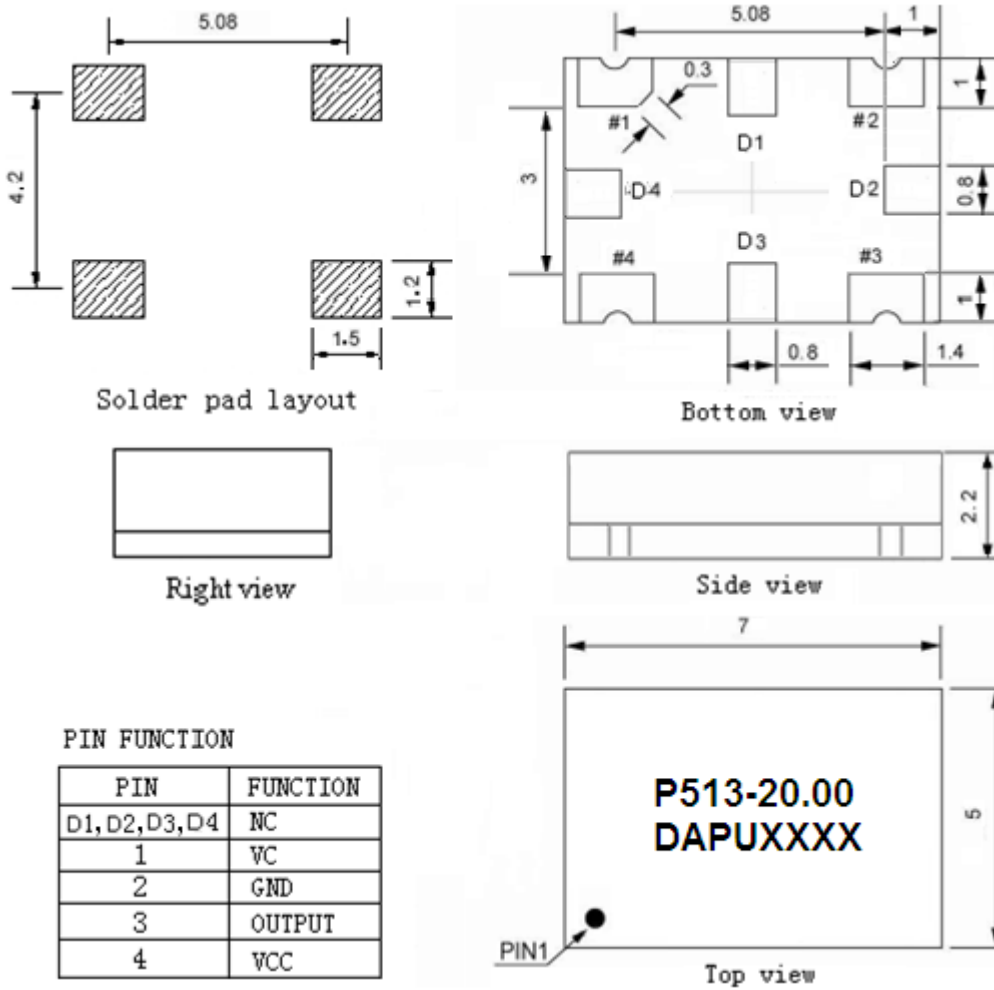

Note1: Tolerance $\pm 0.2\text{mm}$ without mark

Note2: The first two xx representative: week

After two xx representative: year

Note3: Referential Weight 0.2g

Note4: NC is not connect

3. Test Circuit

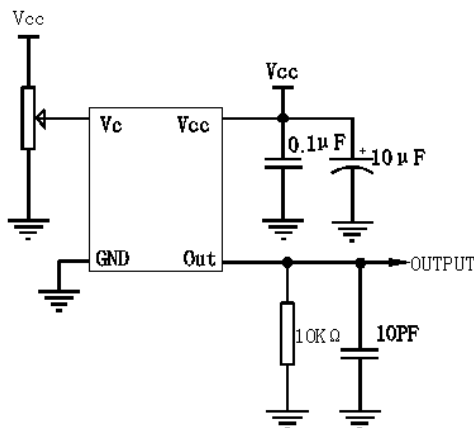



4. Reflow Soldering Curve (RoHS)



5. Package: Tape & Reel (mm)

