



DP0636C

ENG PART:DP-7.0CM-1181T1391-CCW

1181MHz to 1391MHz Single-Junction Surface Mount Circulator

REV.	DESCRIPTION	REVISOR	DATE	APPROVED
A	Creating datasheet	ZC.Wu	2021/9/6	Nick

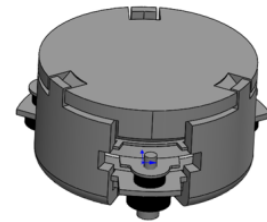

Applications:

- Wireless Infrastructure
- Power Amplifier

Features:

- Operating frequency range: 1181MHz to 1391MHz
- Operating temperature range: -40°C to +85°C
- Storage temperature range: -55°C to +120°C
- Small surface-mount package delivered on T&R
- BeOfree&RoHS compliant

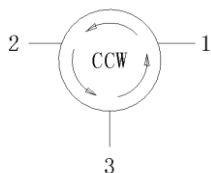

Block Diagram



Electrical Specifications:

ITEM	SPECIFICATION	
Frequency	1181~1391	MHz
Direction	CCW	
Impedance	Typ: 50	Ω
Insertion Loss (Max.)	1.7	dB
Isolation (Min.)	8	dB
Return Loss (Min.)	8	dB
Pass band Ripple (25°C)	1.1	dB
3rd IMD (Max.)	-	dBc
Group delay	-	ns
2nd harmonic	-	dBc
3rd harmonic	-	dBc
Power FWD/REV/PEAK	20/20/100	W
Termination/Attenuator	-	W/dB
Out Band Resonance	-	
Input Impedance ,real	-	Ω
Input Impedance ,imaginary	-	$j\Omega$

Notes:

1. Exposure to maximum rating conditions for extended periods may reduce device reliability. There is no damage to device with only one parameter set at the limit and all other parameters set at or below their nominal value. Exceeding any of the limits listed here may result in permanent damage to the device.
2. Performance is guaranteed under the conditions listed in this table and over the operating temperature range.



Mechanical Specifications:

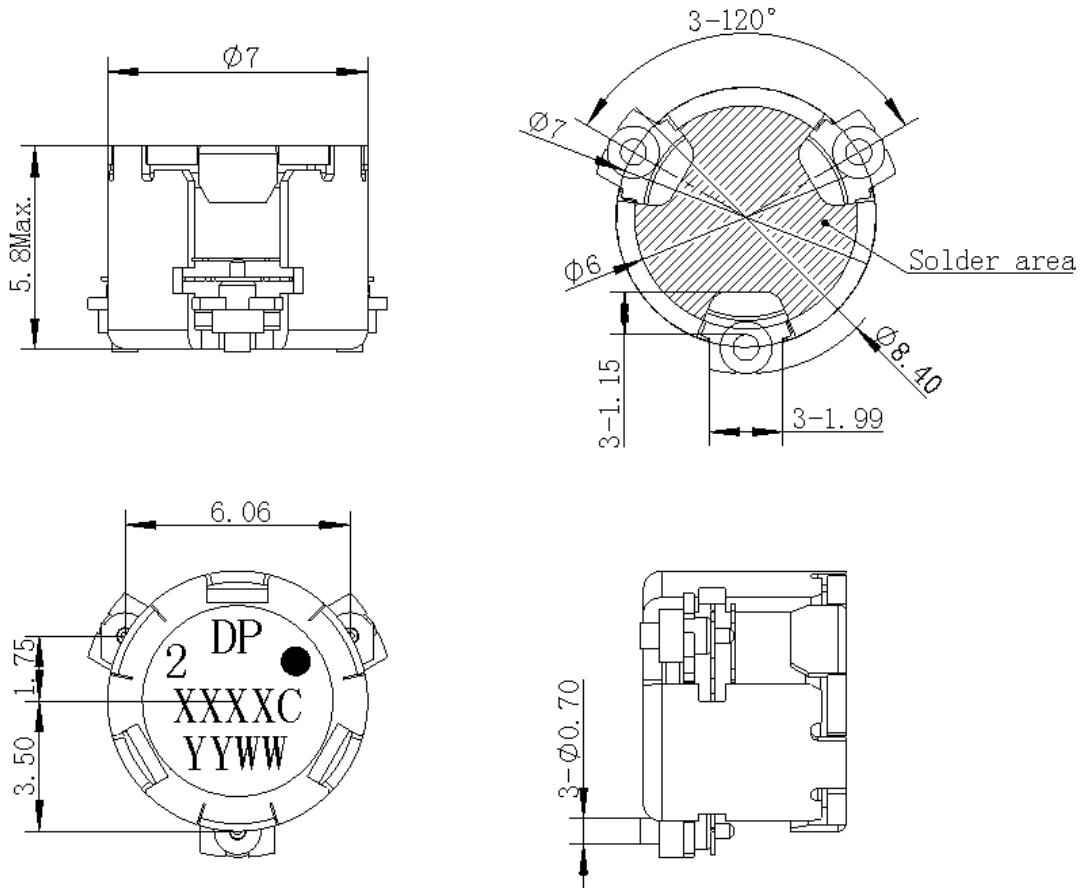

Unit: Millimeters

Notes:

1. The housing and pins are silver-plated.
2. Tolerance $\pm 0.2\text{mm}$ unless otherwise specified.
3. Co-planarity Specification: 0.1mm maximum.
4. Part Number, Lot Code, and Port Designation are printed on the top side of device.
5. The **XXXXC** on the label represents the last five digits of the Part Number
6. Date code is in format **YYWW**
7. The black dot on the label represents the input port



Packaging Style:

ITEM	W	A0	B0	C0	K0	D	E	F	F2	P	P0	P2	T
DIM	24	Φ7.4	9.2	2.7	6.0	Φ1.5	1.75	11.5	-	20	4	2	0.5
TOLE	±0.2	±0.2	±0.2	±0.2	±0.2	+0.1	±0.1	±0.15	±0.1	±0.1	±0.1	±0.1	±0.05

