

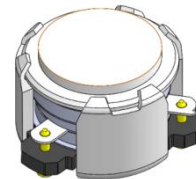

DP0329C

2110MHz to 2200MHz Single-Junction Surface Mount Circulator

REV.	DESCRIPTION	REVISOR	DATE	APPROVED
A	Creating datasheet	ZC.Wu	2020/09/27	Nick



Applications:

- Wireless Infrastructure
- Power Amplifier

Features:

- Operating frequency range: 2110MHz to 2200MHz
- Operating temperature range: -40°C to +125°C
- Storage temperature range: -50°C to +135°C
- Small surface-mount package delivered on T&R
- BeO free & RoHS compliant

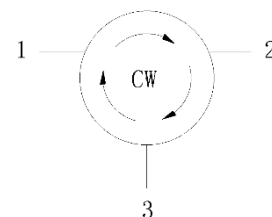

Block Diagram



Electrical Specifications:

ITEM	SPECIFICATION	
Frequency	2110~2200	MHz
Direction	CW	
Impedance	Typ: 50	Ω
Insertion Loss (Max.)	0.25	dB
Isolation (Min.)	20.0@2110~2200MHz 20.0@2020~2290MHz 10.0@1930~2380MHz	dB
Return Loss (Min.)	20.0@2110~2200MHz 20.0@2020~2290MHz 10.0@1930~2380MHz	dB
3rd IMD (Max.)	-65@2x5W CW tones, 5MHz spacing	dBc
Group delay	2	ns
2nd harmonic	/	dBc
3rd harmonic	/	dBc
Power FWD/REV/PEAK	20/20/160	W
Termination/Attenuator	/	W/dB
Input Impedance ,real	/	Ω
Input Impedance ,imaginary	/	$j\Omega$

Notes :

1. Exposure to maximum rating conditions for extended periods may reduce device reliability. There is no damage to device with only one parameter set at the limit and all other parameters set at or below their nominal value. Exceeding any of the limits listed here may result in permanent damage to the device.
2. Performance is guaranteed under the conditions listed in this table and over the operating temperature range.



Mechanical Specifications:

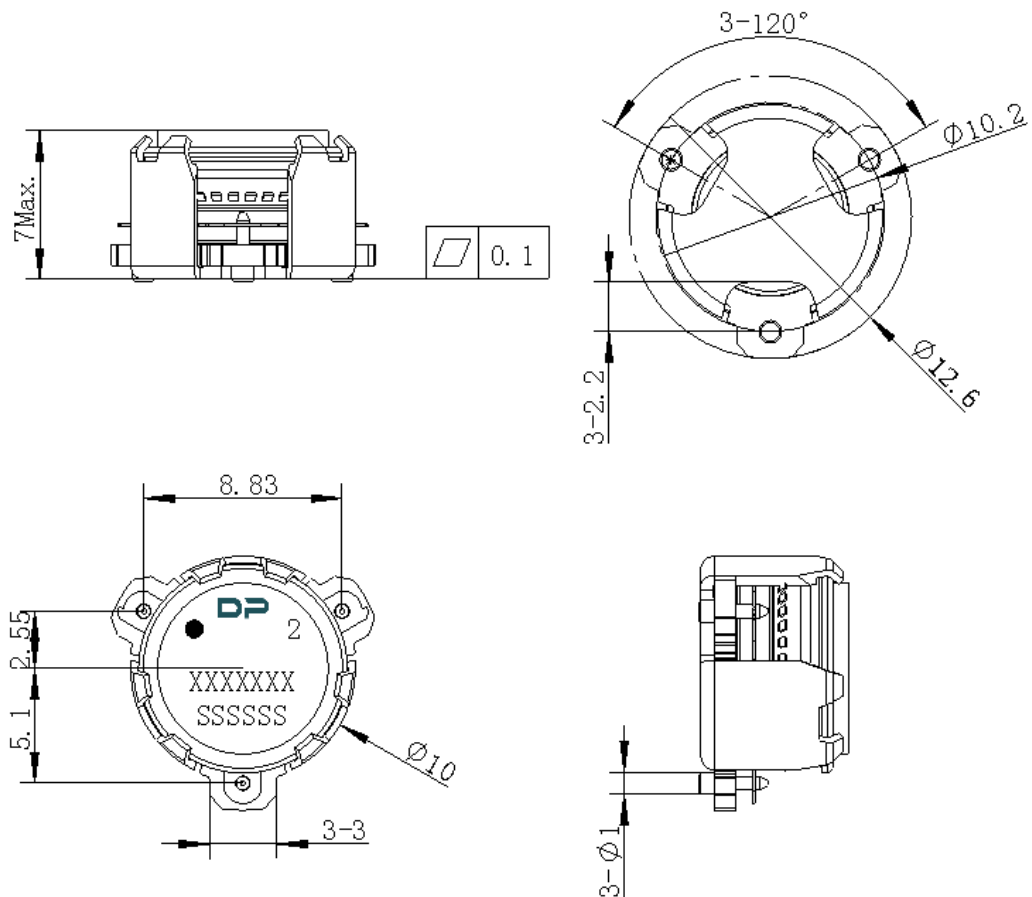

Unit : Millimeters

Notes:

1. The housing and pins are silver-plated.
2. Tolerance ± 0.2 mm unless otherwise specified.
3. Co-planarity Specification: 0.1mm maximum.
4. Part Number, Lot Code, and Port Designation are printed on the top side of device
5. Part Number format shall be XXXXXXX
6. Serial Number format shall be SSSSS



Packaging Style:

ITEM	W	A0	B0	C0	K0	D	E	F	F2	P	P0	P2	T
DIM	32	Φ10.4	12.5	4	7.0	Φ1.5	1.75	14.2	28.5	24	4	2	0.5
TOLE	±0.3	±0.2	±0.2	±0.2	±0.2	+0.1	±0.1	±0.15	±0.1	±0.1	±0.1	±0.1	±0.05

