

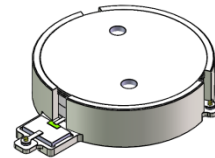

DP0153S

380MHz to 385MHz Single-Junction Surface Mount Isolator

Revision A



Applications:

- Wireless Infrastructure
- Power Amplifier

Features:

- Operating frequency range: 380MHz to 385MHz
- Operating temperature range: -40°C to +85°C
- Storage temperature range: -55°C to +140°C
- Small surface-mount package delivered on T&R
- BeO free & RoHS compliant

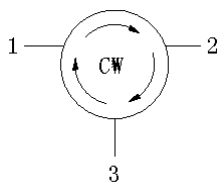

Block Diagram



Electrical Specifications:

ITEM	SPECIFICATION	
Frequency	380~385	MHz
Direction	CW	
Impedance	Typ: 50	Ω
Insertion Loss (Max.)	0.25@25°C \pm 5°C 0.30@-40°C ~+85°C	dB
Isolation (Min.)	25.0@25°C \pm 5°C 22.0@-40°C ~+85°C	dB
Return Loss (Min.)	25.0@25°C \pm 5°C 22.0@-40°C ~+85°C	dB
3rd IMD (Max.)	-75@2x10W, Spacing 1MHz	dBc
2nd harmonic	-	dBc
3rd harmonic	-	dBc
Power FWD/REV/PEAK	80/80/-	W
Termination/Attenuator	150/30 \pm 1	W/dB

Notes :

1. Exposure to maximum rating conditions for extended periods may reduce device reliability. There is no damage to device with only one parameter set at the limit and all other parameters set at or below their nominal value. Exceeding any of the limits listed here may result in permanent damage to the device.
2. Performance is guaranteed under the conditions listed in this table and over the operating temperature range.
3. Performance will not degrade by > 10% (Insertion loss > 20%) with an operating temperature of up to 130 °C.



Mechanical Specifications:

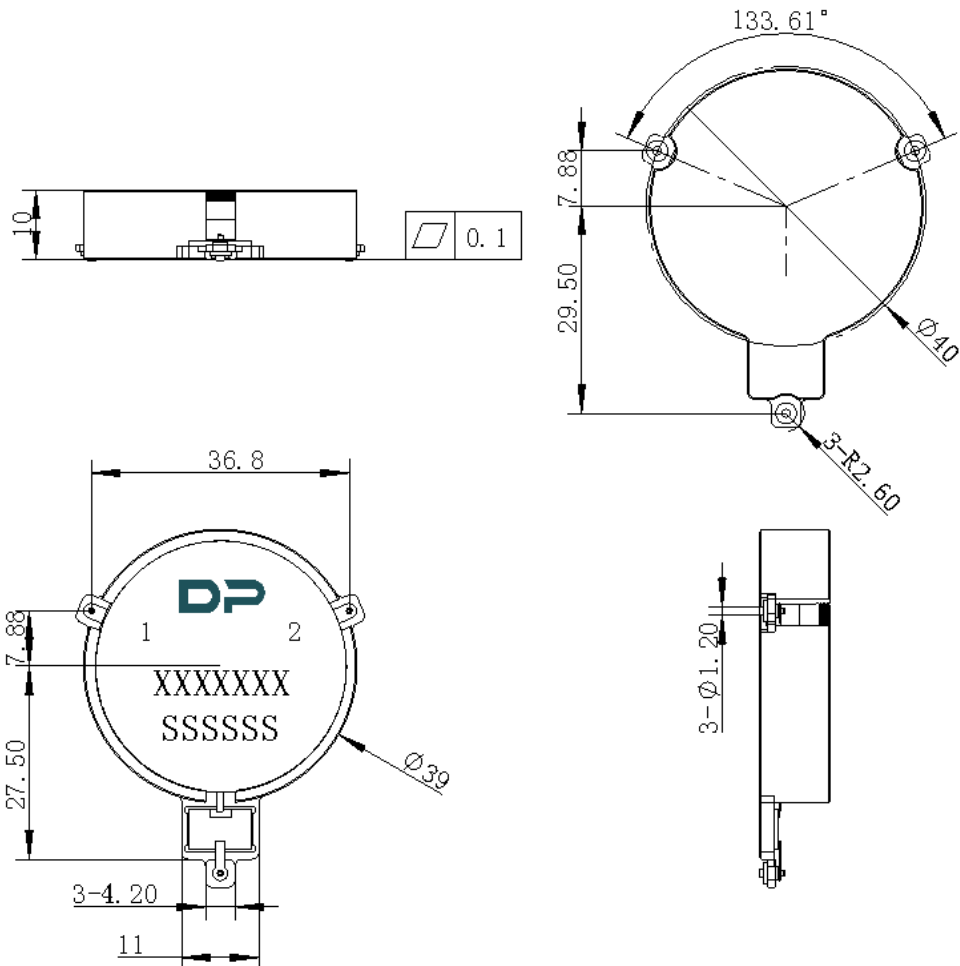

Unit : Millimeters

Notes:

1. The housing and pins are silver-plated.
2. Tolerance ± 0.2 mm unless otherwise specified.
3. Co-planarity Specification: 0.1mm maximum.
4. Part Number, Lot Code, and Port Designation are printed on the top side of device.
5. Part Number format shall be XXXXXXX
5. Serial Number format shall be SSSSSS