

To Customer: _____

Realtime Clock Module

INS5A4803

Datasheet

Document Version 1.0

Released on Dec. 30, 2022

Product Name	Orderable Part Number
INS5A4803 ±5ppm @ -40°C~+85°C	INS5A4803

Customer confirmed:

Version	Change Contents	Prepared by	Revised Date
V1.0	First Issued		2022.12.30

Index

1	OVERVIEW	5
2	BLOCK DIAGRAM	5
3	FEATURES	5
4	PIN DEFINITION	6
5	ELECTRICAL CHARACTERISTICS	7
5.1	ABSOLUTE MAXIMUM RATINGS	7
5.2	RECOMMENDED OPERATING CONDITIONS.....	7
5.3	FREQUENCY CHARACTERISTICS	7
5.4	DC CHARACTERISTICS	7
5.5	AC CHARACTERISTICS.....	8
6	REGISTERS	10
6.1	REGISTER LISTS	10
6.2	DETAILS OF REGISTERS.....	12
6.2.1	<i>Clock counter registers</i>	12
6.2.2	<i>Alarm registers</i>	14
6.2.3	<i>Timer control registers</i>	14
6.2.4	<i>Extension registers</i>	14
6.2.5	<i>Flag registers</i>	15
6.2.6	<i>Control registers</i>	15
6.2.7	<i>Temperature register</i>	16
6.2.8	<i>Device ID register</i>	16
6.2.9	<i>RSV register</i>	16
6.2.10	<i>Frequency Offset register</i>	16
6.2.11	<i>Sub-second timer register</i>	17
6.3	SPI BUS INTERFACE	18
6.3.1	<i>Write process</i>	18
6.3.2	<i>Read process</i>	19

7	REFLOW SOLDERING CURVE.....	20
8	PACKAGE DIMENSION	21
9	PACKING INFORMATION.....	22
10	CONTACT INFORMATION	23

DAPU Confidential
FOR customer

1 Overview

INS5A4803 is a high-accuracy SPI bus interface real-time clock with low power consumption. It embeds a 32.768KHz TCXO. The high precise temperature sensor and temperature compensated circuit ensure the high clock accuracy. It supports calendar (year, month, day, hour, minute, second), clock and timer functions etc. The SOP package and AEC-Q100 compliant makes it suitable for automotive applications.

2 Block Diagram

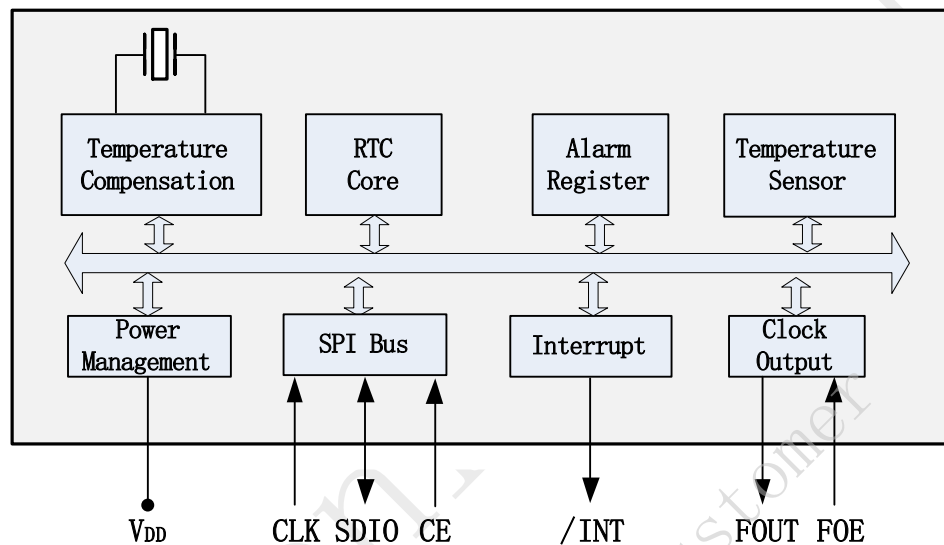

Figure 1. Block Diagram

3 Features

- Low current consumption:1.0uA (Typ.)
- High stability:
<math>< \pm 5\text{ppm @ } -40^{\circ}\text{C} \sim +85^{\circ}\text{C}</math>
- Communication Interface: SPI bus
- Build-in TCXO: 32.768KHz
- Build-in temperature sensor
- Power Supply Voltage:1.6V~5.5V
- Operation Temperature Range: -40°C~+85°C
- Leap years autocorrection
- Timer output function with adjustable period
- Package: SOP14
- AEC-Q100 Compliant

4 Pin definition

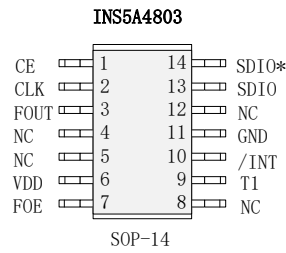

Table1. Pin Definition

Pin Number	Pin Name	I/O	Description
1	CE	In	3-wire SPI chip select pin. Internal pull-down. High: the chip is selected, access is allowed. Low: access the chip is forbidden.
2	CLK	In	3-wire SPI serial clock input pin. Cannot be left floating in normal mode.
3	FOUT	Out	Frequency output. Controlled by FOE. Frequency can be set by FSEL bits.
4	NC	-	Leave to be floating or connected to VDD or GND.
5	NC	-	Leave to be floating or connected to VDD or GND.
6	V _{DD}	-	Power supply
7	FOE	In	FOUT output control pin. Cannot be left floating. High: enable FOUT. Low: FOUT Hi-Z.
8	NC	-	Leave to be floating or connected to VDD or GND.
9	T1	-	Ensure to be floating.
10	/INT	Out	Interrupt Output, Open-Drain.
11	GND	-	Ground
12	NC	-	Leave to be floating or connected to VDD or GND.
13	SDIO	In/ Out	3-wire SPI serial data input/output pin. Cannot be left floating in normal mode.
14	SDIO*	In/ Out	3-wire SPI serial data input/output pin. Cannot be left floating in normal mode.

*Note: pin13 and pin14 are connected internal.

5 Electrical Characteristics

5.1 Absolute Maximum Ratings

Table2. Absolute Maximum Ratings

Parameter	Symbol	Value			Unit	Notes
		Min.	Typ.	Max.		
Power Supply Voltage	V _{DD}	-0.3		6.5	V	
Input Voltage	V _{IN}	GND-0.3		6.5	V	FOE, CLK, SDIO, CE
Clock Output Voltage	V _{OUT1}	GND-0.3		V _{DD} +0.3	V	FOUT
Output Voltage	V _{OUT2}	GND-0.3		6.5	V	SDIO, /INT
Storage temperature	T _{STG}	-55		125	°C	

5.2 Recommended Operating Conditions

Table3. Recommended Operating Conditions

Parameter	Symbol	Value			Unit	Notes
		Min.	Typ.	Max.		
Power Supply Voltage	V _{DD}	1.6	3.0	5.5	V	
Operation temperature	T _{OPR}	-40	25	85	°C	

Note 1: V_{DD} need to be supplied with more than 2.5V at least for the oscillation to stabilize (oscillation start time t_{STA}).

Note2: After powered off, ensure that V_{DD}=GND for more than 10 seconds before next power on

Note3: If there is no special indication, the test conditions are GND = 0V, VDD = 2.5V ~ 5.5V, Ta = - 40 °C ~ + 85 °C

5.3 Frequency Characteristics

Table4. Frequency Characteristics

Parameter	Symbol	Value			Unit	Notes
		Min.	Typ.	Max.		
Frequency stability	Δf/f	-5		5	ppm	-40°C~+85°C
Oscillation start time	t _{STA}			1	s	@25°C
Year Aging	f _a	-3		3	ppm	@25°C, First year
Temperature Sensor Accuracy	T _{emp}	-5		5	°C	V _{DD} =3.0V
FOUT duty cycle	t _w /t	40	50	60	%	

Note: If there is no special indication, the test conditions are GND = 0V, VDD = 2.5V ~ 5.5V, Ta = - 40 °C ~ + 85 °C

5.4 DC Characteristics

Table5. DC Characteristics

Parameter	Symbol	Value			Unit	Notes	
		Min.	Typ.	Max.			
Average Current consumption1	I _{DD1}		1.25	5.1	uA	V _{DD} =5.0V	f _{SCL} =0Hz, FOE=GND, /INT = V _{DD} ; FOUT off (High-Z); Compensation interval 2s;
Average Current consumption2	I _{DD2}		1.0	4.9		V _{DD} =3.0V	
Average Current consumption3	I _{DD3}		5.8	20	uA	V _{DD} =5.0V	f _{SCL} =0Hz, FOE=V _{DD} , /INT = V _{DD} ; FOUT:32.768kHz, CL=0pF; Compensation interval 2s;
Average Current consumption4	I _{DD4}		3.8	19		V _{DD} =3.0V	
High-level input voltage	V _{IH}	0.8*V _{DD}		5.5	V	CE, CLK, SDIO, FOE	
Low-level input voltage	V _{IL}	GND-0.3		0.2*V _{DD}	V		
High-level output voltage	V _{OH1}	4.0		5.0	V	V _{DD} =5.0V, I _{OH} = -1mA	FOUT
	V _{OH2}	2.2		3.0		V _{DD} =3.0V, I _{OH} = -1mA	
	V _{OH3}	2.9		3.0		V _{DD} =3.0V, I _{OH} = -100uA	
Low-level output voltage	V _{OL1}	GND		GND+0.5	V	V _{DD} =5.0V, I _{OL} = 1mA	FOUT
	V _{OL2}	GND		GND+0.8		V _{DD} =3.0V, I _{OL} = 1mA	
	V _{OL3}	GND		GND+0.1		V _{DD} =3.0V, I _{OL} = 100uA	
	V _{OL4}	GND		GND+0.25	V	V _{DD} =5.0V, I _{OL} = 1mA	/INT
	V _{OL5}	GND		GND+0.4		V _{DD} =3.0V, I _{OL} = 1mA	
	V _{OL6}	GND		GND+0.4		V _{DD} ≥3.0V, I _{OL} = 3mA	
Input leakage current	I _{LK}	-0.5		0.5	uA	CE, FOE, SDIO, CLK, V _{IN} = V _{DD} or GND	
Output leakage current	I _{OZ}	-0.5		0.5	uA	FOUT, SDIO, /INT, V _{IN} = V _{DD} or GND	

5.5 AC Characteristics

Table6. AC Characteristics

V_{DD} =3.0V; GND=0V; Ta=-40°C~+85°C

Parameter	Symbol	Value			Unit	Notes
		Min.	Typ.	Max.		
CLK clock cycle	t _{CLK}	330	-		ns	
CLK Low pulse width	t _{LOW}	160	-		ns	
CLK High pulse width	t _{HIGH}	160	-		ns	
Write data setup time	t _{DS}	50	-		ns	
Write data hold time	t _{DH}	50	-		ns	
CE setup time	t _{CS}	150	-		ns	
CE hold time	t _{CH}	150	-		ns	

Parameter	Symbol	Value			Unit	Notes
		Min.	Typ.	Max.		
CLK rise & fall time	t_{RF}		-	50	ns	20%~80%
CE rise & fall time	t_{CERF}		-	50	ns	20%~80%

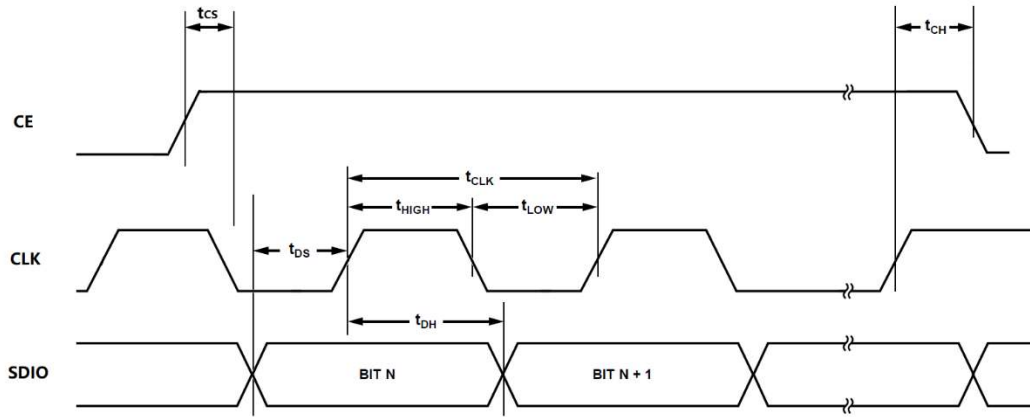

Figure 2. SPI bus Timing Chart

6 Registers

6.1 Register Lists

Address 0x00~0x0F: Basic Time and Calendar Registers

Address 0x10~0x1F: Extended Register Group 1

Address 0x20~30: Extended Register Group 2

Note: 0x10~16 and 0x00~06 with the same function, 0x1B~1F and 0x0B~0F with the same function

Table 7. Basic Time and Calendar Registers

Address	Function	bit7	bit6	bit5	bit4	bit3	bit2	bit1	bit0	R/W
0x00	SEC	○	BCD code, Second tens place, 0-5			BCD code, Second ones place, 0-9				R/W
0x01	MIN	○	BCD code, Minute tens place, 0-5			BCD code, Minute ones place, 0-9				R/W
0x02	HOUR	○	○	BCD code, Hour tens place, 0-2		BCD code, Hour ones place, 0-9				R/W
0x03	WEEK	○	6	5	4	3	2	1	0	R/W
0x04	DAY	○	○	BCD code, Day tens place, 0-3		BCD code, Day ones place, 0-9				R/W
0x05	MONTH	○	○	○	BCD code, Month tens place, 0-1	BCD code, Month ones place, 0-9				R/W
0x06	YEAR	BCD code, Year tens place, 0-9				BCD code, Year ones place, 0-9				R/W
0x07	RAM	●	●	●	●	●	●	●	●	R/W
0x08	MIN Alarm	AE	BCD code, Minute tens place, 0-5			BCD code, Minute ones place, 0-9				R/W
0x09	HOUR Alarm	AE	●	BCD code, Hour tens place, 0-2		BCD code, Hour ones place, 0-9				R/W
0x0A	WEEK Alarm	AE	6	5	4	3	2	1	0	R/W
	DAY Alarm		●	BCD code, Day tens place, 0-3		BCD code, Day ones place, 0-9				R/W
0x0B	Timer Counter 0	128	64	32	16	8	4	2	1	R/W
0x0C	Timer Counter 1	●	●	●	●	2048	1024	512	256	R/W
0x0D	Extension Register	TEST	WADA	USEL	TE	FSEL [1]	FSEL [0]	TSEL [1]	TSEL [0]	R/W
0x0E	Flag Register	○	○	UF	TF	AF	○	VLF	Reserved	R/W
0x0F	Control Register	CSEL [1]	CSEL [0]	UIE	TIE	AIE	○	○	RESET	R/W

Table8. Extended Register Group 1

Address	Function	bit7	bit6	bit5	bit4	bit3	bit2	bit1	bit0	R/W
0x10	SEC	○	BCD code, Second tens place, 0-5			BCD code, Second ones place, 0-9				R/W
0x11	MIN	○	BCD code, Minute tens place, 0-5			BCD code, Minute ones place, 0-9				R/W
0x12	HOUR	○	○	BCD code, Hour tens place, 0-2		BCD code, Hour ones place, 0-9				R/W
0x13	WEEK	○	6	5	4	3	2	1	0	R/W
0x14	DAY	○	○	BCD code, Day tens place, 0-3		BCD code, Day ones place, 0-9				R/W
0x15	MONTH	○	○	○	BCD code, Month tens place, 0-1	BCD code, Month ones place, 0-9				R/W
0x16	YEAR	BCD code, Year tens place, 0-9				BCD code, Year ones place, 0-9				R/W
0x17	TEMP	128	64	32	16	8	4	2	1	R
0x18	RSV	Reserved								-
0x19	Not use	○	○	○	○	○	○	○	○	R
0x1A	Not use	○	○	○	○	○	○	○	○	R
0x1B	Timer Counter 0	128	64	32	16	8	4	2	1	R/W
0x1C	Timer Counter 1	●	●	●	●	2048	1024	512	256	R/W
0x1D	Extension Register	TEST	WADA	USEL	TE	FSEL [1]	FSEL [0]	TSEL [1]	TSEL [0]	R/W
0x1E	Flag Register	○	○	UF	TF	AF	○	VLF	Reserved	R/W
0x1F	Control Register	CSEL [1]	CSEL [0]	UIE	TIE	AIE	○	○	RESET	R/W

Table9. Extended Register Group2

Address	Function	bit7	bit6	bit5	bit4	bit3	bit2	bit1	bit0	R/W
0x20	Device ID	VendorID[3:0]				Ver[3:0]				R
0x21	RSV	Reserved: Ensure to be 0x80								R/W
0x22-24	RSV	Reserved: Ensure to be 0x00								R/W
0x25	Frequency Offset0	S [9]	S [8]	S [7]	S [6]	S [5]	S [4]	S [3]	S [2]	R/W
0x26	Frequency Offset1	S [1]	S [0]	D [5]	D [4]	D [3]	D [2]	D [1]	D [0]	R/W
0x27	SubSEC	Reserved				SubSEC[3:0]				R
0x28-30	RSV	Reserved: Ensure to be 0x00								R/W

Note:

1, After power-up reset or in case VLF bit returns “1”, make sure to initialize all registers to default state before using the RTC. Ensure all inputs are in the required range and the defined values are set for the reserved bits in case the clock cannot work normally.

- ✓ During the initial power-up, below bits will be in the state as below:
 - Initial 0:TEST, WADA, USEL, TE, FSEL[1:0], TSEL[0], UF, TF, AF, CSEL[1], UIE, TIE, RESET,
 - Initial 1:VLF, CSEL[0].
- ✓ All other register values are undefined, so make sure to reset the module before using it.
- ✓ The bits marked with “○” can be read out “0” only after initializing.
- ✓ The bits marked with “●” are RAM bits which can be used to write or read any data.
- ✓ Only 0 can be written to UF, TF, AF, VLF bits.
- ✓ Make sure “0” to be written for TEST bits which are used for testing only.
- ✓ Reserved bits must be set to the defined values accordingly.

6.2 Details of Registers

6.2.1 Clock counter registers

Address	Function	bit7	bit6	bit5	bit4	bit3	bit2	bit1	bit0	Default
0x00/10	SEC	○	BCD code, Second tens place, 0-5			BCD code, Second ones place, 0-9				0x00
0x01/11	MIN	○	BCD code, Minute tens place, 0-5			BCD code, Minute ones place, 0-9				0x00
0x02/12	HOUR	○	○	BCD code, Hour tens place, 0-2		BCD code, Hour ones place, 0-9				0x00

SEC: BCD format, Value: 0~59

MIN: BCD format, Value: 0~59

HOUR: BCD format, Value: 0~23

Address	Function	bit7	bit6	bit5	bit4	bit3	bit2	bit1	bit0	Default
0x03/13	WEEK	○	6	5	4	3	2	1	0	0x40

WEEK: Value 01h, 02h, 04h, 08h, 10h, 20h, 40h. Only one bit can be set to 1 each time, all others must be set to 0.

Table10. WEEK Register

WEEK	Data	bit7	bit6	bit5	bit4	bit3	bit2	bit1	bit0
Sunday	01h	0	0	0	0	0	0	0	1
Monday	02h	0	0	0	0	0	0	1	0
Tuesday	04h	0	0	0	0	0	1	0	0
Wednesday	08h	0	0	0	0	1	0	0	0
Thursday	10h	0	0	0	1	0	0	0	0

WEEK	Data	bit7	bit6	bit5	bit4	bit3	bit2	bit1	bit0
Friday	20h	0	0	1	0	0	0	0	0
Saturday	40h	0	1	0	0	0	0	0	0

Address	Function	bit7	bit6	bit5	bit4	bit3	bit2	bit1	bit0	Default
0x04/14	DAY	○	○	BCD code, Day tens place, 0-3		BCD code, Day ones place, 0-9				0x01

DAY: BCD format, the value range will be adjusted automatically according to the month setting and if a leap year or not .

Table11. DAY Register Value

Month	Day Value Range
1, 3, 5, 7, 8, 10, 12	1~31
4, 6, 9, 11	1~30
February in normal year	1~28
February in leap year	1~29

Address	Function	bit7	bit6	bit5	bit4	bit3	bit2	bit1	bit0	Default
0x05/15	MONTH	○	○	○	BCD code, Month tens place, 0-1	BCD code, Month ones place, 0-9				0x01
0x06/16	YEAR	BCD code, Year tens place, 0-9				BCD code, Year ones place, 0-9				0x00

MONTH: BCD format, Value1~12

YEAR: BCD format, Value0~99(2000~2099)

Example: 2020/01/01 Wednesday 21:18:36

Address	Function	bit7	bit6	bit5	bit4	bit3	bit2	bit1	bit0
0x00/10	SEC	○	0	1	1	0	1	1	0
0x01/11	MIN	○	0	0	1	1	0	0	0
0x02/12	HOUR	○	○	1	0	0	0	0	1
0x03/13	WEEK	○	0	0	0	1	0	0	0
0x04/14	DAY	○	○	0	0	0	0	0	1
0x05/15	MONTH	○	○	○	0	0	0	0	1
0x06/16	YEAR	0	0	1	0	0	0	0	0

6.2.2 Alarm registers

Address	Function	bit7	bit6	bit5	bit4	bit3	bit2	bit1	bit0	Default
0x08	MIN Alarm	AE	BCD code, Minute tens place, 0-5			BCD code, Minute ones place, 0-9				0x00
0x09	HOUR Alarm	AE	●	BCD code, Hour tens place, 0-2		BCD code, Minute ones place, 0-9				0x00
0x0A	WEEK Alarm	AE	6	5	4	3	2	1	0	0x00
	DAY Alarm		●	BCD code, Day tens place, 0-3		BCD code, Day ones place, 0-9				

According to AIE, AF, WADA bits setting, the alarm interrupt will be generated once the current time match the settings in the above registers, the /INT pin goes to low level and AF bit is set to ‘1’ to record an alarm interrupt event has occurred.

WEEK Alarm/DAY Alarm: Controlled by WADA bit in 0x0D register

AE: Alarm Enable bit, 0-enable; 1-disenable

AF: Defined in 0x0E register bit3

AIE: Defined in 0x0F register bit3

6.2.3 Timer control registers

Address	Function	bit7	bit6	bit5	bit4	bit3	bit2	bit1	bit0	Default
0x0B/1B	Timer Counter 0	128	64	32	16	8	4	2	1	0x00
0x0C/1C	Timer Counter 1	●	●	●	●	2048	1024	512	256	0x00

According to TE, TF, TIE, TSEL[1:0] bits setting, a timer interrupt will be generated once the value counts down to 0 from the one set in the above registers.

TE: Defined in 0x0D register bit4

TF: Defined in 0x0E register bit4

TIE: Defined in 0x0F register bit4

TSEL [1:0]: Defined in 0x0D register bit1 and bit0

6.2.4 Extension registers

Address	Function	bit7	bit6	bit5	bit4	bit3	bit2	bit1	bit0	Default
0x0D/1D	Extension Register	TEST	WADA	USEL	TE	FSEL[1]	FSEL[0]	TSEL[1]	TSEL[0]	0x02

TEST: Test bit, must be set to“0”

WADA: Week Alarm/Day Alarm control bit, decide 0x0A register as DAY Alarm or WEEK Alarm. 0-WEEK alarm, 1-DAY alarm

USEL: Update Interrupt Select bit, 0-output interrupt once a second, 1-output interrupt once a minute

TE: Timer Enable bit, 0-disable, 1-enable

FSEL[1], FSEL[0]:FOUT frequency setting:

FSEL[1]	FSEL[0]	FOUT Frequency
0	0	32.768KHz(Default)
0	1	1024Hz
1	0	1Hz
1	1	32.768KHz

TSEL[1], TSEL[0]:Timer countdown period(source clock) setting:

TSEL[1]	TSEL[0]	Source clock
0	0	4096Hz
0	1	64Hz
1	0	1Hz
1	1	1/60Hz

6.2.5 Flag registers

Address	Function	bit7	bit6	bit5	bit4	bit3	bit2	bit1	bit0	Default
0x0E/1E	Flag Register	○	○	UF	TF	AF	○	VLF	Reserved	0x03

UF: Update flag bit. When time update interrupt event occurs, it will be set to “1”and keeps“1” until a “0” is written to it.

TF: Timer Flag bit. When a fixed-cycle timer interrupt event occurs, it will be set to “1” and keeps“1” until a “0” is written to it.

AF: Alarm Flag bit. When an alarm interrupt event occurs, it will be set to “1” and keeps“1” until a “0” is written to it.

VLF: Voltage Low Flag bit. When supply voltage is lower than 1.6V, it will be set to “1” and keeps “1” until a “0” is written to it.

6.2.6 Control registers

Address	Function	bit7	bit6	bit5	bit4	bit3	bit2	bit1	bit0	Default
0x0F/1F	Control Register	CSEL [1]	CSEL [0]	UIE	TIE	AIE	○	○	RESET	0x40

CSEL[1], CSEL[0]: Compensation interval Select 1, 0 bits, used to set temperature compensation interval.

CSEL[1]	CSEL[0]	Compensation interval
0	0	0.5s
0	1	2s(default)
1	0	10s
1	1	30s

UIE: Update Interrupt Enable bit. When UF changes from “0” to “1”, this bit controls if an interrupt signal is generated. 0-disable (/INT keeps Hi-Z), 1-enable (/INT status changes from Hi-Z to Low).

TIE: Timer Interrupt Enable bit: When TF changes from “0” to “1”, this bit controls if an interrupt signal is generated. 0-disable (/INT keeps Hi-Z), 1-enable (/INT status changes from Hi-Z to Low).

AIE: Alarm Interrupt Enable bit: When AF changes from “0” to “1”, this bit controls if an interrupt signal is generated. 0-disable (/INT keeps Hi-Z), 1-enable (/INT status changes from Hi-Z to Low).

RESET: Reset IC, prepared for the synchronized starting of time or timer.

6.2.7 Temperature register

Address	Function	bit7	bit6	bit5	bit4	bit3	bit2	bit1	bit0	Default
0x17	TEMP	128	64	32	16	8	4	2	1	0x00

Read digital temperature data, $Temp[°C] = (TEMP[7:0] * 2 - 147.5) / 3.0448$.

6.2.8 Device ID register

Address	Function	bit7	bit6	bit5	bit4	bit3	bit2	bit1	bit0	Default
0x20	Device ID	Vendor ID[3:0]				Ver[3:0]				0xD2

Vendor ID[3:0]:The fixed value is defined as Vendor ID[3:0]=1101b=Dh to represent DAPU.

Ver[3:0]: version of the IC

6.2.9 RSV register

Address	Function	bit7	bit6	bit5	bit4	bit3	bit2	bit1	bit0	Default
0x21	RSV	Reserved: must be 0x80								0x80
0x22~ 0x24	RSV	Reserved: must be 0x00								0x00

6.2.10 Frequency Offset register

Address	Function	bit7	bit6	bit5	bit4	bit3	bit2	bit1	bit0	Default
0x25	Frequency Offset0	Reserved	Reserved	Reserved	Reserved	Reserved	S [4]	S [3]	S [2]	0x00
0x26	Frequency Offset1	S [1]	S [0]	D [5]	D [4]	D [3]	D [2]	D [1]	D [0]	0x00

S [4:0]: Sign bits. Only 2b' 0 0000 and 2b' 1 1111 is legitimate.

D [5:0]: Data bits

S [4:0]	D [5:0]	Frequency Adjustment (ppm)
2b' 0 0000	2b'00 0000	0 (Default)
	2b'00 0001	-0.1
	2b'00 0010	-0.2

	2b'11 1110	-6.2
	2b'11 1111	-6.3
2b' 1 1111	2b'11 1111	+0.1
	2b'11 1110	+0.2

	2b'00 0010	+6.2
	2b'00 0001	+6.3
Other's	Other's	Invalid value, must be avoided.

Note: *The Frequency offset register affects the frequency stability. Please be careful if you adjust it.

The offset function is effective for frequency adjustment at the normal temperature.

The single adjustment amount of 0.1ppm is approximate value.

6.2.11 Sub-second timer register

Address	Function	bit7	bit6	bit5	bit4	bit3	bit2	bit1	bit0	Default
0x27	SubSEC	Reserved				SubSEC[3:0]				0x00

SubSEC[3:0]: sub second bit, and unit is 1/16s.

6.3 SPI Bus Interface

It is assumed CPU is master and INS5A4803 is slave in this section.

The INS5A4803 includes SPI as the slave interface. The INS5A4803 registers can be accessed via an SPI bus. The following figure shows the specifications of the INS5A4803 SPI interface. Data length is 8 bits and MSB first. CLK keeps high at idle. Maximum communication speed is 4Mbits/s. Address auto-increment function is included. The CE pin has a built-in pull-down.

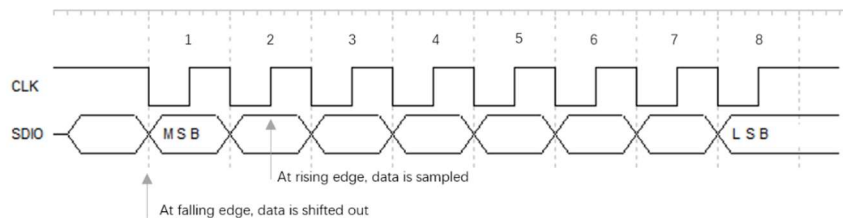

6.3.1 Write process

After the host pulls up the CE signal, the INS5A4803 is selected as the slave device to be accessed. Then the host starts to output CLK. The host first sends an 8-bit address data to the SDIO pin, the highest bit is the write flag bit, and the lower seven bits are the register address.

Bit7	Bit6	Bit5	Bit4	Bit3	Bit2	Bit1	Bit0
0	Register address						
Write flag bit	0x00~0x30, Refer to Section 6.1						

During the register data writing operation, each time 8-bit data is written, the data will be stored in the specified register address. When writing continuously, the lower 4 bits of the register address will be incremented automatically. When the low 4 bits of the register address exceed 0xF, they are recognized as 0x0. The high-order 3-bit address of the register is not incremented automatically. If necessary, cancel the CE signal and restart the next write operation.

Do not set the CE signal to low level before the last 8-bit data is completely transmitted. If the CE signal is set to low level during transmission, 8-bit data that has not been sent will be lost and will not be written to the register.

Single register write operation:

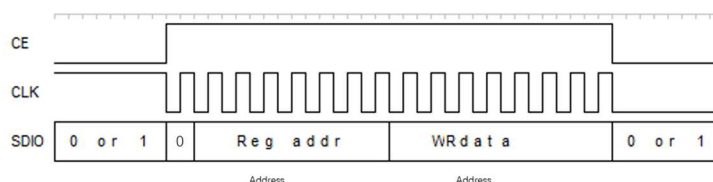

Continuous register write operation:

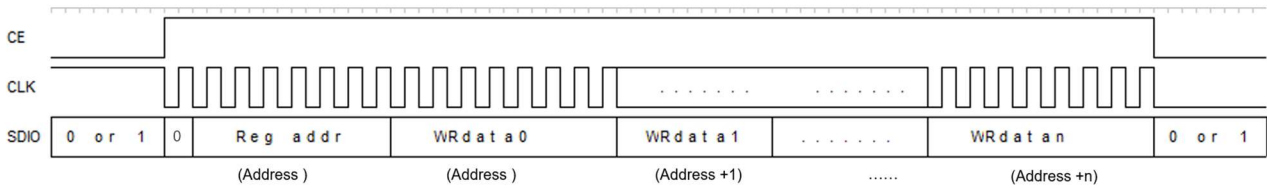

6.3.2 Read process

After the host pulls up the CE signal, the INS5A4803 is selected as the slave device to be accessed. Then the host starts to output CLK. The host first sends an 8-bit address data (register address) to the DIO pin of the INS5A4803, including the read flag bit. After receiving the address data, the INS5A4803 sends the read data from the DIO pin to the host in 8-bit units until the host stops outputting the clock.

Bit7	Bit6	Bit5	Bit4	Bit3	Bit2	Bit1	Bit0
1	Register address						
Read flag bit	0x00~0x30, Refer to Section 6.1						

When reading continuously, the lower 4 bits of the register address will be incremented automatically. When the low 4 bits of the register address exceed 0xF, they are recognized as 0x0. The high-order 3-bit address of the register is not incremented automatically. If necessary, cancel the CE signal and restart the next read operation.

Single register read operation:

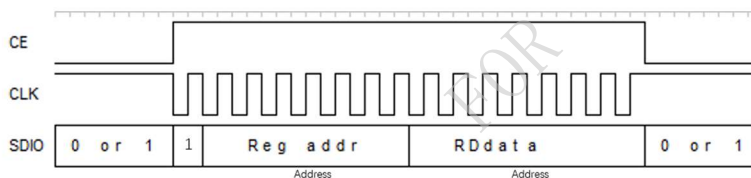

Continuous register read operation:

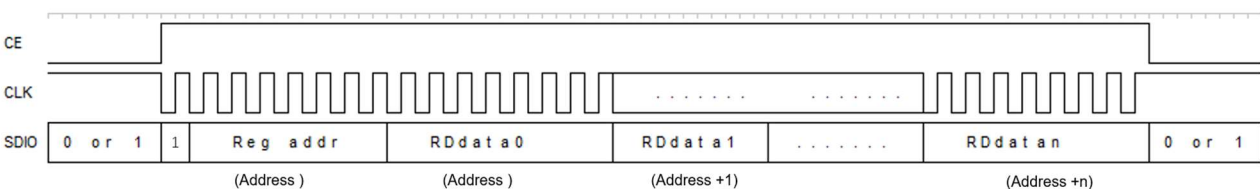

7 Reflow Soldering Curve

Standard: IPC/JEDEC J-STD-020

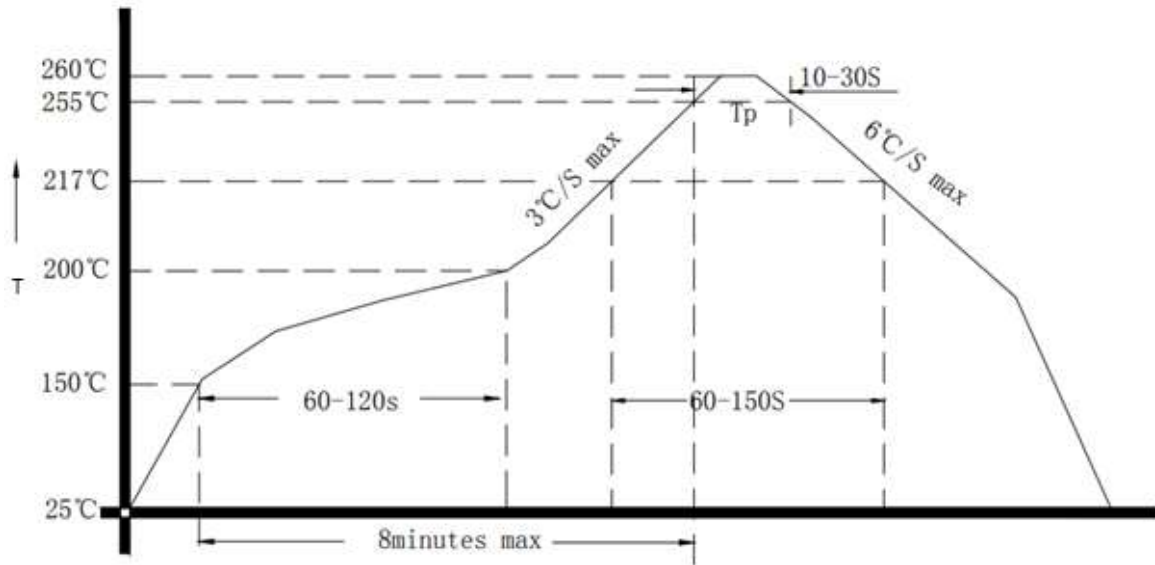

Reflow Soldering Curve

Note: It is suggested to solder IC under the condition shown in the curve above. Must pay attention to the temperature and time when manual soldering, if the temperature over +260°C, or you will make the xo performance bad, even damage it.

8 Package Dimension

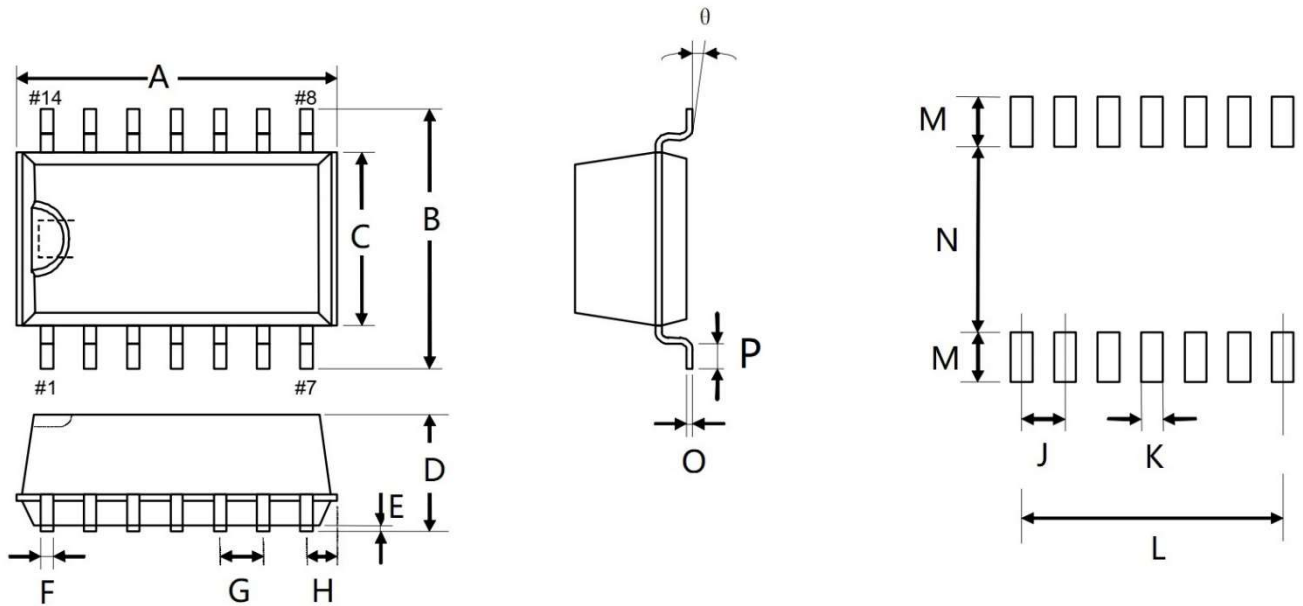

Dimension	Min.	Typ.	Max.
A	10.0	10.1	10.2
B	7.2	7.4	7.6
C	4.9	5.0	5.1
D	3.1	3.2	3.3
E	0.055	--	0.205
F	--	0.406	--
G	--	1.27	--
H	--	1.2	--
P	0.5	0.6	0.7
O	--	0.13	--
θ	1°		8°

Unit: mm

Dimension	Typ.
J	1.27
K	0.7
L	7.62
M	1.4
N	5.4

Unit: mm

Figure 3. Recommended Soldering Pattern and Dimension

9 Packing Information

REEL DIMENSIONS

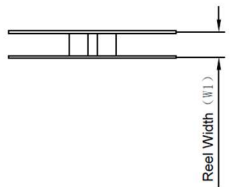
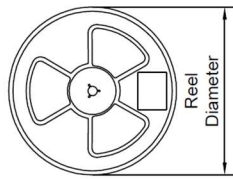

TAPE DIMENSIONS

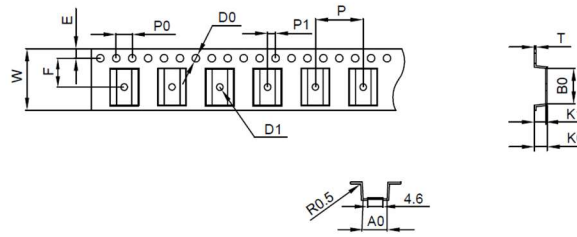

QUADRANT ASSIGNMENTS FOR PIN 1 ORIENTATION IN TAPE

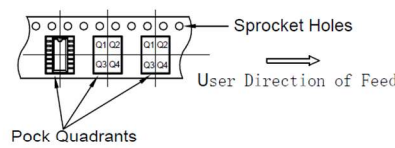

Device	Package Type	Pins	SPQ	Reel Diameter (mm)	Reel Width W1 (mm)	A0 (mm)	B0 (mm)	D0 (mm)	D1 (mm)	E (mm)	F (mm)	T (mm)	K0 (mm)	K1 (mm)	W (mm)	P (mm)	P0 (mm)	P1 (mm)	PIN1 Quadrant
INS5A4803	SOP	14	1500pcs	330	16	8.0 ±0.1	10.4 ±0.1	1.5 +0.1 -0.0	1.5 +0.1 -0.0	1.75 ±0.1	7.5 ±0.1	0.3 ±0.05	3.8 ±0.1	3.5 ±0.1	16.0 +0.3 -0.3	12.0 ±0.1	4.0 ±0.1	2.0 ±0.1	Q1

Figure 4. Reel and tape

10 Contact Information

Website: <http://www.dptel.com>

Email: sales@dptel.com

Tel: (+86 0769)88010888

Address: Bldg. 5, SSL Modern Enterprise Accelerator Zone, Dongguan, Guangdong, 523429 China

DAPU Confidential
FOR customer