



INS5A8804—Automotive High Accuracy I²C RTC

Key Features

- Low current consumption: 1.5 uA (Typ.)
- High stability:
 ±5ppm @ -40°C~+90°C
 ±20ppm@ +90°C~+105°C
- Build-in TCXO: 32.768KHz
- Build-in temperature sensor
- Communication Interface: I²C bus
- Power Supply Voltage:1.6V~5.5V
- Operation Temperature Range: -40°C~+105°C
- Leap years autocorrection
- Time stamp trigger function
- Timer output function with adjustable period
- Package: 3.2mm × 2.5mm × 0.9mm
- AEC-Q100 Compliant

Block Diagram

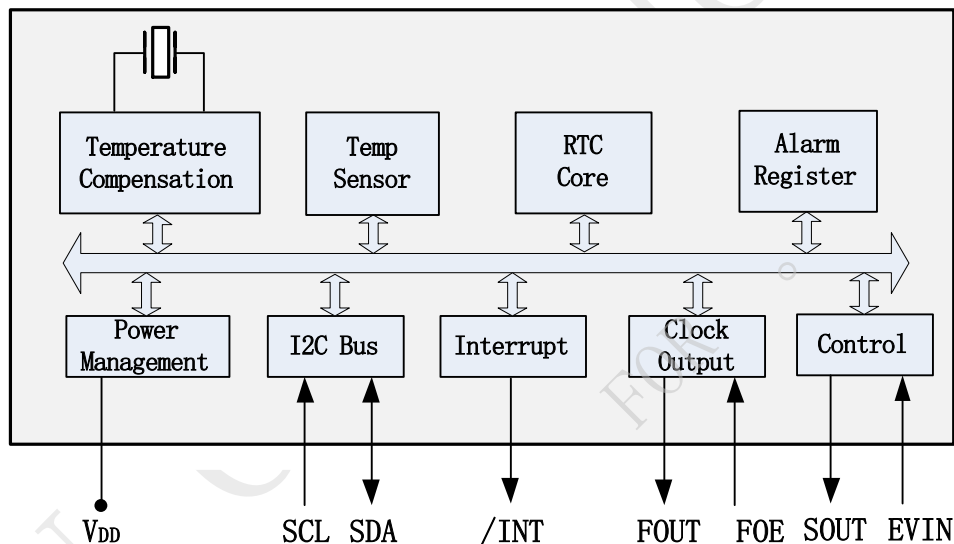

Overview

INS5A8804 is a high-accuracy I²C bus interface real-time clock with low power consumption. It embeds a 32.768KHz TCXO. The high precise temperature sensor and temperature compensated circuit ensure the high clock accuracy. It supports calendar (year, month, day, hour, minute, second), clock and timer functions etc. The SMD3225 package with only 0.9mm thickness and AEC-Q100 compliant makes it suitable for automotive applications.



Index

1	OVERVIEW	5
2	BLOCK DIAGRAM	5
3	FEATURES	5
4	PIN DEFINITION	6
5	ELECTRICAL CHARACTERISTICS	7
5.1	ABSOLUTE MAXIMUM RATINGS	7
5.2	RECOMMENDED OPERATING CONDITIONS	7
5.3	FREQUENCY CHARACTERISTICS	7
5.4	DC CHARACTERISTICS	8
5.5	AC CHARACTERISTICS	8
6	REGISTERS	10
6.1	REGISTER LISTS	10
6.2	DETAILS OF REGISTERS	12
6.2.1	<i>Clock counter registers</i>	12
6.2.2	<i>Alarm registers</i>	14
6.2.3	<i>Timer control registers</i>	14
6.2.4	<i>Control registers 1</i>	15
6.2.5	<i>Flag registers</i>	15
6.2.6	<i>Control registers 2</i>	16
6.2.7	<i>SOUT Control register</i>	16
6.2.8	<i>Time Stamp Data Event Controller register</i>	17
7	I²C BUS INTERFACE	20
7.1	CAUTIONS	20
7.2	SLAVE ADDRESS	20
7.3	I ² C BUS PROTOCOL	20
7.3.1	<i>Write process</i>	20
7.3.2	<i>Read process</i>	21
8	REFLOW SOLDERING CURVE	22



9 DIMENSIONS	23
10 PACKAGE	24

DAPU Confidential
FOR



1 Overview

INS5A8804 is a high-accuracy I²C bus interface real-time clock with low power consumption. It embeds a 32.768KHz TCXO. The high precise temperature sensor and temperature compensated circuit ensure the high clock accuracy. It supports calendar (year, month, day, hour, minute, second), clock and timer functions etc. The SMD3225 package with only 0.9mm thickness and AEC-Q100 compliant makes it suitable for automotive applications.

2 Block Diagram

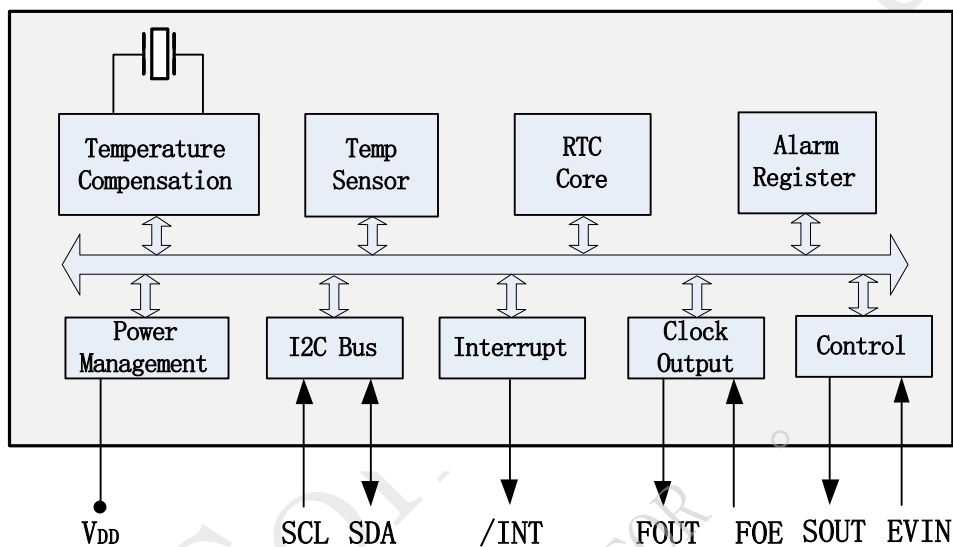

Figure 1. Block Diagram

3 Features

- Low current consumption: 1.5 uA (Typ.)
- High stability:
 - ±5ppm @ -40°C~+90°C
 - ±20ppm@ +90°C~ +105°C
- Communication Interface: I2C bus
- Build-in TCXO: 32.768KHz
- Build-in temperature sensor
- Power Supply Voltage:1.6V~5.5V
- Operation Temperature Range: -40°C~+105°C
- Leap years autocorrection
- Time stamp trigger function
- Timer output function with adjustable period
- Package: 3.2mm × 2.5mm × 0.9mm
- AEC-Q100 Compliant



4 Pin definition

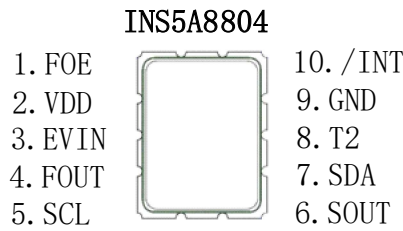

Table1. Pin Definition

Pin Number	Pin Name	I/O	Description
1	FOE	In	FOUT output control pin. “1”- enable FOUT, “0”-FOUT Hi-Z
2	V _{DD}	-	Power supply
3	EVIN	In	Trigger input terminal for time stamps.
4	FOUT	Out	Frequency output. Controlled by FOE. Frequency can be set by FSEL bits.
5	SCL	In	I ² C clock signal
6	SOUT	Out	SOUT is push-pull for the inside state output SOUT outputs state of a specified flag bit or programmed logical 1 or 0
7	SDA	In/Out	I ² C data signal
8	T2	-	Manufacturer test only. Ensure to be floating
9	GND	-	Ground
10	/INT	Out	Interrupt Output, Open-Drain



5 Electrical Characteristics

5.1 Absolute Maximum Ratings

Table2. Absolute Maximum Ratings

Parameter	Symbol	Value			Unit	Notes
		Min.	Typ.	Max.		
Power Supply Voltage	V _{DD}	-0.3		6.5	V	
Backup Battery Voltage	V _{BAT}	-0.3		6.5	V	
Input Voltage	V _{IN}	GND-0.3		6.5	V	FOE, SCL, SDA, EVIN
Output Voltage	V _{OUT1}	GND-0.3		V _{DD} +0.3	V	FOUT, SOUT
	V _{OUT2}	GND-0.3		6.5	V	SDA, /INT
Storage temperature	T _{STG}	-55		125	°C	

5.2 Recommended Operating Conditions

Table3. Recommended Operating Conditions

Parameter	Symbol	Value			Unit	Notes
		Min.	Typ.	Max.		
Power Supply Voltage	V _{DD}	1.6	3.0	5.5	V	
Current consumption	I _{DD}		1.5		uA	@25°C
Operation temperature	T _{OPR}	-40	25	105	°C	

Note 1: During the power on and oscillation starting time, a voltage of more than 2.5V must be provided to ensure the oscillation circuit to a stable state.

Note2: After the power supply is removed or power off, ensure that VDD=GND for more than 10 seconds before next power on cycle.

Note3: If there is no special indication, the test conditions are GND =0V, VDD=1.6V~5.5V, Ta=-40°C~+105°C

5.3 Frequency Characteristics

Table4. Frequency Characteristics

Parameter	Symbol	Value			Unit	Notes
		Min.	Typ.	Max.		
Frequency stability	Δf/f	-5		+5	ppm	-40°C~+90°C
Frequency stability	Δf/f	-20		+20	ppm	+90°C~+105°C
Oscillation start time	t _{STA}			1	s	@25°C
Year Aging	f _a			5	ppm	@25°C, First year
FOUT duty cycle	t _{w/t}	40	50	60	%	



5.4 DC Characteristics

Table5. DC Characteristics

Parameter	Symbol	Value			Unit	Notes	
		Min.	Typ.	Max.			
Average Current consumption1	I _{DD1}		1.6	50	uA	V _{DD} =5.0V	f _{SCL} =0Hz, FOE=GND, /INT = V _{DD} ; FOUT off (High-Z); Compensation interval 2s;
Average Current consumption2	I _{DD2}		1.5	45		V _{DD} =3.0V	
Average Current consumption3	I _{DD3}		4.5	50	uA	V _{DD} =5.0V	f _{SCL} =0Hz, FOE=V _{DD} , /INT = V _{DD} ; FOUT:32.768kHz, CL=0pF; Compensation interval 2s;
Average Current consumption4	I _{DD4}		2.5	45		V _{DD} =3.0V	
High-level input voltage	V _{IH}	0.8*V _{DD}		5.5V	V	SCL, SDA, FOE, EVIN	
Low-level input voltage	V _{IL}	GND-0.3		0.2*V _{DD}	V		
High-level output voltage	V _{OH1}	4.0		5.0	V	V _{DD} =5.0V, I _{OH} = -1mA	FOUT, SOUT
	V _{OH2}	2.2		3.0		V _{DD} =3.0V, I _{OH} = -1mA	
	V _{OH3}	2.9		3.0		V _{DD} =3.0V, I _{OH} = -100uA	
Low-level output voltage	V _{OL1}	GND		GND+0.5	V	V _{DD} =5.0V, I _{OL} = 1mA	FOUT, SOUT
	V _{OL2}	GND		GND+0.8		V _{DD} =3.0V, I _{OL} = 1mA	
	V _{OL3}	GND		GND+0.1		V _{DD} =3.0V, I _{OL} = 100uA	
	V _{OL4}	GND		GND+0.25	V	V _{DD} =5.0V, I _{OL} = 1mA	/INT
	V _{OL5}	GND		GND+0.4	V	V _{DD} =3.0V, I _{OL} = 1mA	
	V _{OL6}	GND		GND+0.4	V	V _{DD} ≥3.0V, I _{OL} = 3mA	SDA
Input leakage current	I _{LK}	-0.5		0.5	uA	FOE, SDA, SCL, EVIN, V _{IN} = V _{DD} or GND	
Output leakage current	I _{OZ}	-0.5		0.5	uA	FOUT, SDA, /INT, SOUT, V _{IN} = V _{DD} or GND	

Note: If there is no special indication, the test conditions are GND=0V, VDD=1.6V~5.5V, Ta=-40°C~+105°C.

5.5 AC Characteristics

Table6. AC Characteristics

Parameter	Symbol	Value			Unit
		Min.	Typ.	Max.	
SCL clock frequency	f _{SCL}			400	kHz
SCL low level time	t _{LOW}	1.3			us
SCL high level time	t _{HIGH}	0.6			us



Parameter	Symbol	Value			Unit
		Min.	Typ.	Max.	
Start condition setup time	$t_{HD;STA}$	0.6			us
Start condition hold time	$t_{SU;STA}$	0.6			us
Stop condition setup time	$t_{SU;STO}$	0.6			us
Bus idle time between start condition and stop condition	t_{RCV}	1.3			us
Data setup time	$t_{SU;DAT}$	100			ns
Data hold time	$t_{HD;DAT}$	0			ns
SCL, SDA rising time	t_r			0.4	us
SCL, SDA falling time	t_f			0.4	us

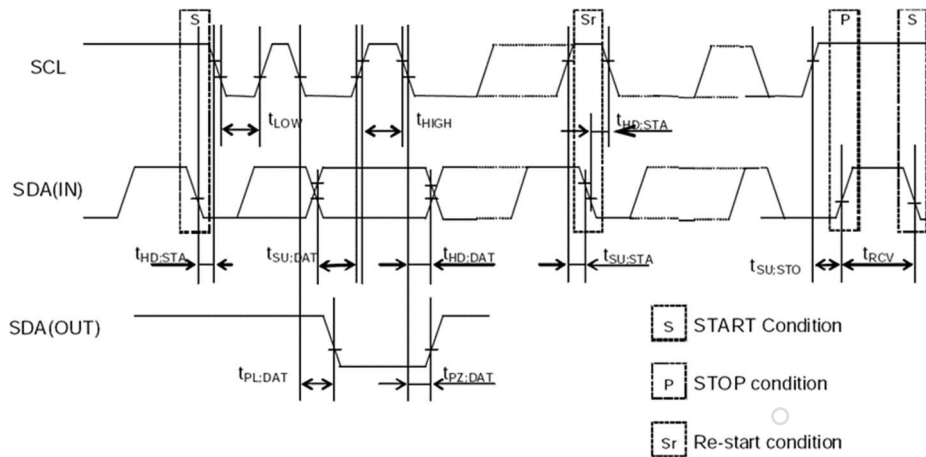

Figure 2. I²C bus Timing Chart

Note: when the master equipment accesses the equipment through I2C bus, all communication from sending start condition to sending stop shall be completed within 1 second. If it exceeds 1 second, the I2C bus interface will be reset through the internal bus timeout function.



6 Registers

6.1 Register Lists

Address 0x00~0x0F: Basic Time and Calendar Registers

Address 0x10~0x1F: Extended Registers

Address 0x20~0x7F: Reserved Registers

Table7. Basic Time and Calendar Registers

Address	Function	bit7	bit6	bit5	bit4	bit3	bit2	bit1	bit0	R/W
0x00	SEC	○	Second tens place, 0-5			Second ones place, 0-9				R/W
0x01	MIN	○	Minute tens place, 0-5			Minute ones place, 0-9				R/W
0x02	HOUR	○	○	Hour tens place, 0-2		Hour ones place, 0-9				R/W
0x03	WEEK	○	6	5	4	3	2	1	0	R/W
0x04	DAY	○	○	Day tens place, 0-3		Day ones place, 0-9				R/W
0x05	MONTH	○	○	○	Month tens place, 0-1	Month ones place, 0-9				R/W
0x06	YEAR	Year tens place, 0-9			Year ones place, 0-9				R/W	
0x07	RAM	●	●	●	●	●	●	●	●	R/W
0x08	MIN Alarm	AE	Minute tens place, 0-5			Minute ones place, 0-9				R/W
0x09	HOUR Alarm	AE	●	Hour tens place, 0-2		Hour ones place, 0-9				R/W
0x0A	WEEK Alarm	AE	6	5	4	3	2	1	0	R/W
	DAY Alarm		●	Day tens place, 0-3		Day ones place, 0-9				R/W
0x0B	Timer Counter 0	128	64	32	16	8	4	2	1	R/W
0x0C	Timer Counter 1	32768	16384	8192	4096	2048	1024	512	256	R/W
0x0D	Control 1	TEST	WADA	USEL	TE	FSEL [1]	FSEL [0]	TSEL [1]	TSEL [0]	R/W
0x0E	Flag Register	○	○	UF	TF	AF	○	VLF	VDET	R/W
0x0F	Control 2	CSEL [1]	CSEL [0]	UIE	TIE	AIE	○	○	RESET	R/W

Table8. Extended Registers



Address	Function	bit7	bit6	bit5	bit4	bit3	bit2	bit1	bit0	R/W
0x10	Time Stamp SEC	○	40	20	10	8	4	2	1	R
0x11	Time Stamp MIN	○	40	20	10	8	4	2	1	R
0x12	Time Stamp HOUR	○	○	20	10	8	4	2	1	R
0x13	Time Stamp WEEK	○	6	5	4	3	2	1	0	R
0x14	Time Stamp DAY	○	○	20	10	8	4	2	1	R
0x15	Time Stamp MONTH	TSVLF	TSVDET	○	10	8	4	2	1	R
0x16	Time Stamp YEAR	80	40	20	10	8	4	2	1	R
0x17	EVIN set	ECP	EHL	EPU	RCE	EIE	○	ET[1]	ET[0]	R/W
0x18	EVIN det	EF	○	○	○	EVMON	○	○	○	R/W
0x19	SOUT set1	SOE[7]	SOE[6]	SOE[5]	SOE[4]	SOE[3]	SOE[2]	SOE[1]	SOE[0]	R/W
0x1A	SOUT set2	DCE	DC	○	○	SRV	FS[2]	FS[1]	FS[0]	R/W
0x1B	Timer set	TSTP	TRES	○	○	○	○	○	○	R/W
0x1C	Timer0	128	64	32	16	8	4	2	1	R
0x1D	Timer1	32768	16384	8192	4096	2048	1024	512	256	R
0x1E	Timer2	8388608	4194304	2097152	1048576	524288	262144	131072	65536	R
0x1F	Timer counter 2	8388608	4194304	2097152	1048576	524288	262144	131072	65536	R/W

Table9. Reserved Registers

Address	Function	bit7	bit6	bit5	bit4	bit3	bit2	bit1	bit0	R/W
0x20-7F	RSV	Reserved: Do not to write								R/W

Note:
 1, After power-up reset or in case VLF bit returns “1”, make sure to initialize all registers to default state before using the RTC. Ensure all inputs are in the required range and the defined values are set for the reserved bits in case the clock cannot work normally.

- ✓ During the initial power-up, below bits will be in the state as below:



Initial 0: TEST, WADA, USEL, TE, FSEL[1:0], TSEL[0], UF, TF, AF, EF,CSEL[1], UIE, TIE, AIE, RESET, TSVLF, TSVDET,
 ECP, EHL, EPU, RCE, EIE, ET[1:0], EVMON, SOE[7:0], DCE, DC, SRV, FS[2:0], TRES, TSTP,
 All bits of address 1Ch,1Dh,1Eh and 1FH.

Initial 1: TSEL[1], VLF, VDET, CSEL[0].

- ✓ All other register values are undefined, so make sure to reset the module before using it.
- ✓ The bits marked with “○” can be read out “0” only after initializing.
- ✓ The bits marked with “●” are RAM bits which can be used to write or read any data.
- ✓ Only 0 can be written to UF, TF, AF, VLF, VDET bits.
- ✓ Make sure “0” to be written for TEST bits which are used for testing only.

6.2 Details of Registers

6.2.1 Clock counter registers

Address	Function	bit7	bit6	bit5	bit4	bit3	bit2	bit1	bit0	Default
0x00	SEC	○	BCD code, Second tens place, 0-5			BCD code, Second ones place, 0-9				0x00
0x01	MIN	○	BCD code, Minute tens place, 0-5			BCD code, Minute ones place, 0-9				0x00
0x02	HOUR	○	○	BCD code, Hour tens place, 0-2		BCD code, Hour ones place, 0-9				0x00

SEC: BCD format, Value: 0~59

MIN: BCD format, Value: 0~59

HOUR: BCD format, Value: 0~23

Address	Function	bit7	bit6	bit5	bit4	bit3	bit2	bit1	bit0	Default
0x03	WEEK	○	6	5	4	3	2	1	0	0x40

WEEK: Value 01h, 02h, 04h, 08h, 10h, 20h, 40h. Only one bit can be set to 1 each time, all others must be set to 0.

Table10. WEEK Register

WEEK	Data	bit7	bit6	bit5	bit4	bit3	bit2	bit1	bit0
Sunday	01h	0	0	0	0	0	0	0	1
Monday	02h	0	0	0	0	0	0	1	0
Tuesday	04h	0	0	0	0	0	1	0	0
Wednesday	08h	0	0	0	0	1	0	0	0
Thursday	10h	0	0	0	1	0	0	0	0
Friday	20h	0	0	1	0	0	0	0	0



WEEK	Data	bit7	bit6	bit5	bit4	bit3	bit2	bit1	bit0
Saturday	40h	0	1	0	0	0	0	0	0

Address	Function	bit7	bit6	bit5	bit4	bit3	bit2	bit1	bit0	Default
0x04	DAY	○	○	BCD code, Day tens place, 0-3		BCD code, Day ones place, 0-9				0x01

DAY: BCD format, the value range will be adjusted automatically according to the month setting and if a leap year or not .

Table11. DAY Register Value

Month	Day Value Range
1, 3, 5, 7, 8, 10, 12	1~31
4, 6, 9, 11	1~30
February in normal year	1~28
February in leap year	1~29

Address	Function	bit7	bit6	bit5	bit4	bit3	bit2	bit1	bit0	Default
0x05	MONTH	○	○	○	BCD code, Month tens place, 0-1	BCD code, Month ones place, 0-9				0x01
0x06	YEAR	BCD code, Year tens place, 0-9				BCD code, Year ones place, 0-9				0x00

MONTH: BCD format, Value1~12

YEAR: BCD format, Value0~99(2000~2099)

Example: 2020/01/01 Wednesday 21:18:36

Address	Function	bit7	bit6	bit5	bit4	bit3	bit2	bit1	bit0
0x00	SEC	○	0	1	1	0	1	1	0
0x01	MIN	○	0	0	1	1	0	0	0
0x02	HOUR	○	○	1	0	0	0	0	1
0x03	WEEK	○	0	0	0	1	0	0	0
0x04	DAY	○	○	0	0	0	0	0	1
0x05	MONTH	○	○	○	0	0	0	0	1
0x06	YEAR	0	0	1	0	0	0	0	0



6.2.2 Alarm registers

Address	Function	bit7	bit6	bit5	bit4	bit3	bit2	bit1	bit0	Default
0x08	MIN Alarm	AE	BCD code, Minute tens place, 0-5			BCD code, Minute ones place, 0-9				0x00
0x09	HOUR Alarm	AE	●	BCD code, Hour tens place, 0-2		BCD code, Minute ones place, 0-9				0x00
0x0A	WEEK Alarm	AE	6	5	4	3	2	1	0	0x00
	DAY Alarm		●	BCD code, Day tens place, 0-3			BCD code, Day ones place, 0-9			

According to AIE, AF, WADA bits setting, the alarm interrupt will be generated once the current time match the settings in the above registers, the /INT pin goes to low level and AF bit is set to ‘1’ to record an alarm interrupt event has occurred.

WEEK Alarm/DAY Alarm: Controlled by WADA bit in 0x0D register

AE: Alarm Enable bit, 0-enable; 1-disenable

AF: Defined in 0x0E register bit3

AIE: Defined in 0x0F register bit3

6.2.3 Timer control registers

Address	Function	bit7	bit6	bit5	bit4	bit3	bit2	bit1	bit0	Default
0x0B	Timer Counter 0	128	64	32	16	8	4	2	1	0x00
0x0C	Timer Counter 1	32768	16384	8192	4096	2048	1024	512	256	0x00
0x1B	Timer set	TSTP	TRES	○	○	○	○	○	○	0x00
0x1C	Timer0	128	64	32	16	8	4	2	1	0xFF
0x1D	Timer1	32768	16384	8192	4096	2048	1024	512	256	0xFF
0x1E	Timer2	8388608	4194304	2097152	1048576	524288	262144	131072	65536	0xFF
0x1F	Timer Counter 2	8388608	4194304	2097152	1048576	524288	262144	131072	65536	0x00

According to TE, TF, TIE, TSEL[1:0] bits setting, a timer interrupt will be generated once the value countdowns to 0 from the one set in the above Timer Counter registers.

TE: Defined in 0x0D register bit4

TF: Defined in 0x0E register bit4



TIE: Defined in 0x0F register bit4

TSEL[1:0]:Defined in 0x0D register bit1 and bit0

TSTP: 0: Timer counter are continued

1: Stop the timer counter

REES: Timer counter reset control

0: Timer counter do not reset

1: Timer counter reset to default value

6.2.4 Control registers 1

Address	Function	bit7	bit6	bit5	bit4	bit3	bit2	bit1	bit0	Default
0x0D	Control 1	TEST	WADA	USEL	TE	FSEL[1]	FSEL[0]	TSEL[1]	TSEL[0]	0x02

TEST: Test bit, must be set to “0”

WADA: WeekAlarm/ DayAlarm control bit, decide 0x0A register as DAY Alarm or WEEK Alarm. 0-WEEK alarm, 1-DAY alarm

USEL: Update Interrupt Select bit, 0-output interrupt once a second, 1-output interrupt once a minute

TE: Timer Enable bit, 0-disable, 1-enable

FSEL[1], FSEL[0]:FOUT frequency setting:

FSEL[1]	FSEL[0]	FOUT Frequency
0	0	32.768KHz(Default)
0	1	1024Hz
1	0	1Hz
1	1	32.768KHz

TSEL[1], TSEL[0]:Timer countdown period(source clock) setting:

TSEL[1]	TSEL[0]	Source clock
0	0	4096Hz
0	1	64Hz
1	0	1Hz
1	1	1/60Hz

6.2.5 Flag registers

Address	Function	bit7	bit6	bit5	bit4	bit3	bit2	bit1	bit0	Default
0x0E	Flag Register	○	○	UF	TF	AF	○	VLF	VDET	0x03

UF: Update flag bit. When time update interrupt event occurs, it will be set to “1”and keeps“1” until a “0” is written to it.



TF: Timer Flag bit. When a fixed-cycle timer interrupt event occurs, it will be set to “1” and keeps “1” until a “0” is written to it.

AF: Alarm Flag bit. When an alarm interrupt event occurs, it will be set to “1” and keeps “1” until a “0” is written to it.

VLF: Voltage Low Flag bit. When supply voltage is lower than 1.6V, it will be set to “1” and keeps “1” until a “0” is written to it.

VDET: Voltage Detection Flag bit. When supply voltage is lower than 1.95V, it will be set to “1” and keeps “1” until a “0” is written to it.

6.2.6 Control registers 2

Address	Function	bit7	bit6	bit5	bit4	bit3	bit2	bit1	bit0	Default
0x0F	Control 2	CSEL [1]	CSEL [0]	UIE	TIE	AIE	○	○	RESET	0x40

CSEL[1], CSEL[0]: Compensation interval Select 1, 0 bits, used to set temperature compensation interval.

CSEL[1]	CSEL[0]	Compensation interval
0	0	0.5s
0	1	2s(default)
1	0	10s
1	1	30s

UIE: Update Interrupt Enable bit. When UF changes from “0” to “1”, this bit controls if an interrupt signal is generated. 0-disable(/INT keeps Hi-Z), 1-enable(/INT status changes from Hi-Z to Low).

TIE: Timer Interrupt Enable bit: When TF changes from “0” to “1”, this bit controls if an interrupt signal is generated. 0-disable(/INT keeps Hi-Z), 1-enable(/INT status changes from Hi-Z to Low).

AIE: Alarm Interrupt Enable bit: When AF changes from “0” to “1”, this bit controls if an interrupt signal is generated. 0-disable(/INT keeps Hi-Z), 1-enable(/INT status changes from Hi-Z to Low).

RESET: Reset IC, prepared for the synchronized starting of time or timer.

6.2.7 SOUT Control register

Address	Function	bit7	bit6	bit5	bit4	bit3	bit2	bit1	bit0	Default
0x19	SOUT set1	SOE[7]	SOE[6]	SOE[5]	SOE[4]	SOE[3]	SOE[2]	SOE[1]	SOE[0]	0x00
0x1A	SOUT set2	DCE	DC	○	○	SRV	FS[2]	FS[1]	FS[0]	0x00

By setting 69h = 0x69 into SOUT set1 SOUT function becomes activated. Other data disable SOUT function, then SOUT becomes Hi-Z.



In case of DCE = 1, DC bit value is outputted at SOUT.

In case of DCE = 0, register value Flag Value is outputted at SOUT. If SRV = 1 then SOUT output reverse. Flag Value is decided by SRV, FS[2:0].

DCE	DC	FS[2]	FS[1]	FS[0]	Flag Value	SOUT Output	
						SRV = 0	SRV = 1
0	X	0	0	0	TF	TF	Inversion of TF
0	X	0	0	1	AF	AF	Inversion of AF
0	X	0	1	0	UF	UF	Inversion of UF
0	X	0	1	1	-	Low	
0	X	1	0	0	VDET	VDET	Inversion of VDET
0	X	1	0	1	VLF	VLF	Inversion of VLF
0	X	1	1	0	-	Low	
0	X	1	1	1	EF	EF	Inversion of EF
1	0	X	X	X	X	Low	
1	1	X	X	X	X	High	

6.2.8 Time Stamp Data Event Controller register

Address	Function	bit7	bit6	bit5	bit4	bit3	bit2	bit1	bit0	Default
0x10	Time Stamp SEC	○	40	20	10	8	4	2	1	0x00
0x11	Time Stamp MIN	○	40	20	10	8	4	2	1	0x00
0x12	Time Stamp HOUR	○	○	20	10	8	4	2	1	0x00
0x13	Time Stamp WEEK	○	6	5	4	3	2	1	0	0x00
0x14	Time Stamp DAY	○	○	20	10	8	4	2	1	0x00



Address	Function	bit7	bit6	bit5	bit4	bit3	bit2	bit1	bit0	Default
0x15	Time Stamp MONTH	TSVLF	TSVDET	○	10	8	4	2	1	0x00
0x16	Time Stamp YEAR	80	40	20	10	8	4	2	1	0x00
0x17	EVIN set	ECP	EHL	EPU	RCE	EIE	○	ET[1]	ET[0]	0x00
0x18	EVIN det	EF	○	○	○	EVMON	○	○	○	0x00

1) Time stamp SEC ~ YEAR

In case of trigger input detection from EVIN terminal, Clock and calendar data are recorded in Time stamp SEC ~ YEAR.

2) Time stamp VLF, Time stamp VDET

In case of trigger input detection from EVIN terminal, VLF bit is recorded to TSVLF, VDET bit to TSVDET.

3) ECP bit (Event capture Enable)

ECP enables Time Stamp function. Time Stamp function is enabled in case of ECP = 1.

4) EHL bit (EVIN pin, High/Low detection select)

Selection bit of EVIN Voltage level. In case of EHL = 0, EVIN pin detects active Low level; In case of EHL = 1, EVIN pin detects active High level.

5) EPU bit (Enable Pull-up register)

EPU enables Pull-up-resistor of EVIN input terminal. 0 – disabled; 1-enabled.

6) RCE bit (Repeat Capture Enable)

RCE enables repeated times stamp capture. 0 – disabled; 1-enabled.

7) EF bit (Event trigger Flag)

History bit of EVIN trigger. 0 – There is no EVIN detection history; 1- There is EVIN detection history.

8) ET[1:0] bits (Event input debounce Time set)

Selection of debounce filtering cycle time.



ET[1]	ET[0]	Filtering Cycle Time
0	0	No filtered(default)
0	1	3.9ms
1	0	15.6ms
1	1	125ms

9) EIE bit (EVIN Interrupt Enable)

/INT Interrupt Enable/Disable selection bit. 0-disable;1-enable.

10) EVMON bit (EVIN Monitor)

EVMON can read the EVIN input level. 0-LOW; 1-HIGH.



7 I²C Bus Interface

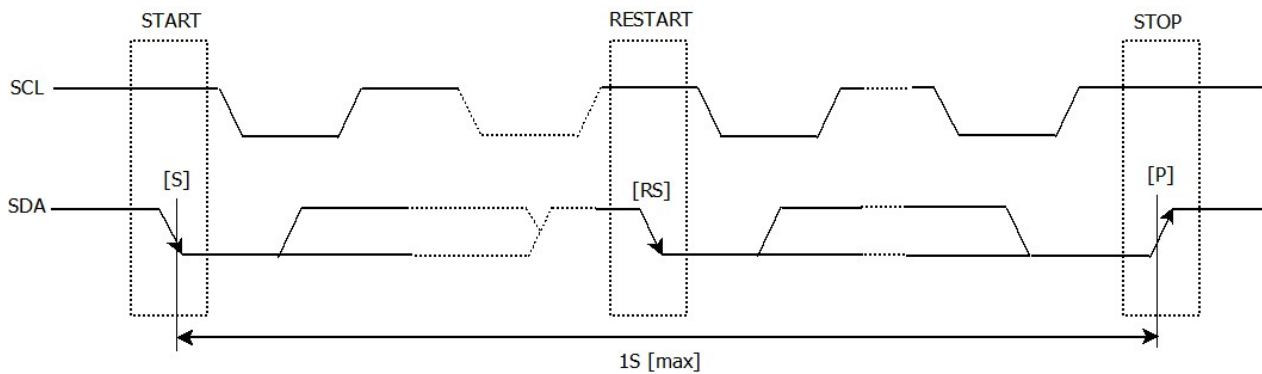

I²C bus supports bi-directional communications through a serial clock line SCL and a serial data line SDA. I²C bus device can be defined as “Master” and “Slave”. INS5A8804 can only be used as Slave.

7.1 Cautions

I²C bus includes START, RESTART, STOP conditions, the duration between START and STOP must be less than 1 second just in case the bus to be set to standby mode automatically. A new START condition must be transferred before restarting of any communications.

INS5A8804 I²C bus interface supports single byte read/write operations as well as multiple bytes incremental access. After 0x7F address, the next one will be 0x00.

7.2 Slave Address

Table 12. I²C Bus Slave Address

Transfer data	Slave address							R/W
	bit7	bit6	bit5	bit4	bit3	bit2	bit1	bit0
65h(Read)	0	1	1	0	0	1	0	1 (Read)
64h(Write)								0 (Write)

INS5A8804 I²C bus Slave Address is [0110 010*].

7.3 I²C bus protocol

It is assumed CPU is master and INS5A8804 is slave in this section.

7.3.1 Write process

I²C bus includes an address auto-increment function, once the initial address has been specified, the



INS5A8804 increments (+1) the address automatically after each data is sent, then to write next data.

- (1) CPU sends start condition[S]
- (2) CPU sends INS5A8804's slave address with R/W bit to set to write mode
- (3) CPU verifies ACK signal from INS5A8804
- (4) CPU sends write address to INS5A8804
- (5) CPU verifies ACK signal from INS5A8804
- (6) CPU sends write data to the address specified at step (4)
- (7) CPU verifies ACK signal from INS5A8804
- (8) Repeat (6) (7) if multiple bytes need to be written, address will be incremented automatically
- (9) CPU ends stop condition[P]

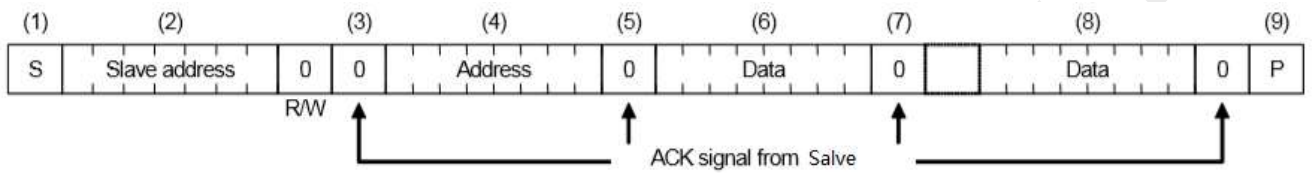

7.3.2 Read process

Writing the address to be read with write mode firstly, then reading the data with read mode.

- (1) CPU sends start condition[S]
- (2) CPU sends INS5A8804's slave address with R/W bit to set to write mode
- (3) CPU verifies ACK signal from INS5A8804
- (4) CPU sends address for reading from INS5A8804
- (5) CPU verifies ACK signal from INS5A8804
- (6) CPU sends RESTART condition [Sr]
- (7) CPU sends INS5A8804's slave address with R/W bit to set to read mode
- (8) CPU verifies ACK signal from INS5A8804
- (9) CPU reads data from the specified address in step (4)
- (10) CPU sends ACK signal for "0"
- (11) Repeat (9) (10) if multiple bytes need to be read, address will be incremented automatically
- (12) CPU sends ACK signal for "1"
- (13) CPU sends stop condition[P]

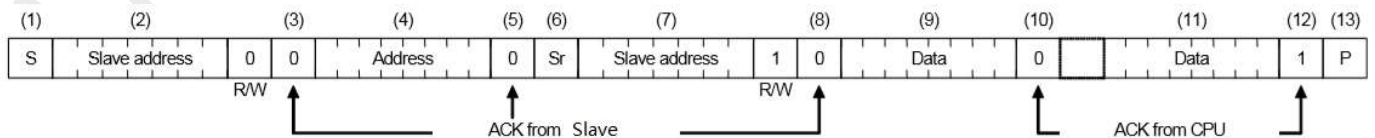



8 Reflow Soldering Curve

Standard: IPC/JEDEC J-STD-020

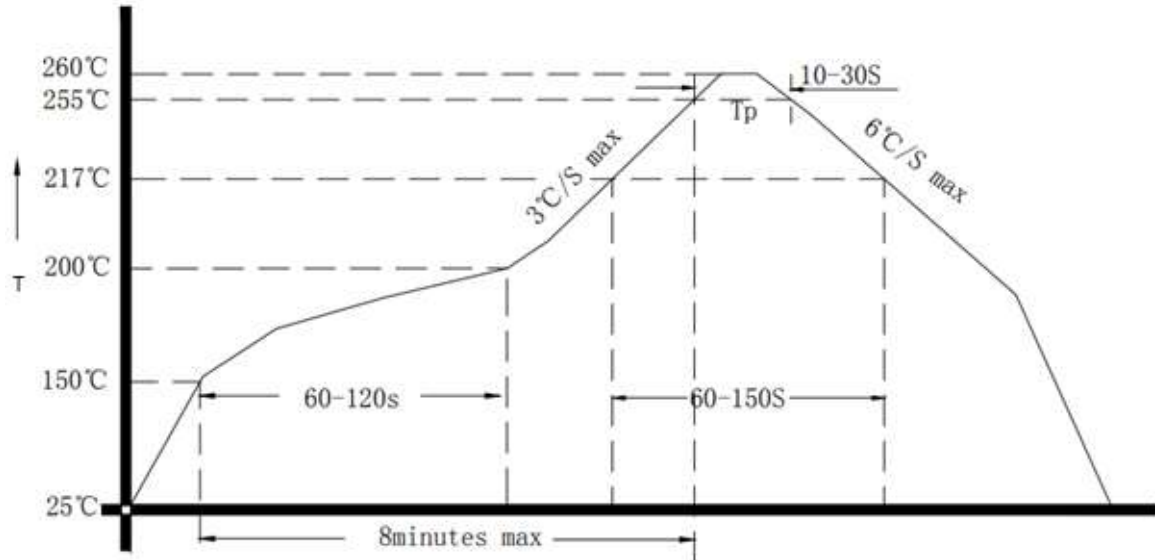
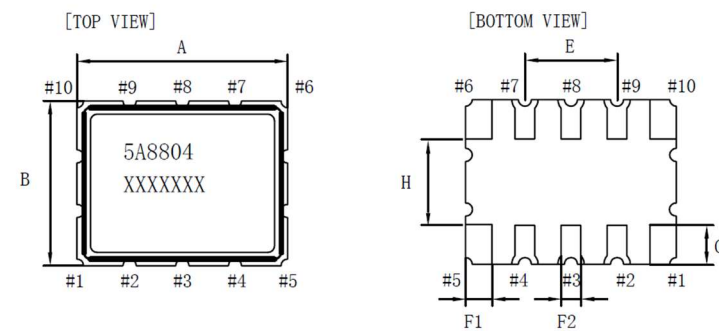

Figure 3. Reflow Soldering Curve

Note: It is suggested to solder IC under the condition shown in the curve above. Must pay attention to the temperature and time when manual soldering, if the temperature over +260°C, or you will make the xo performance bad, even damage it.



9 Dimensions



Dimension	Min.	Typ.	Max.
A	3.1	3.2	3.3
B	2.4	2.5	2.6
C	0.8	0.9	1.0
D	--	0.45	--
E	--	1.4	--
F1	--	0.4	--
F2	--	0.3	--
G	--	0.6	--
H	--	1.3	--

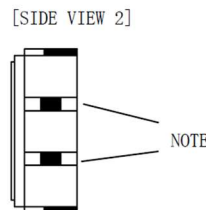
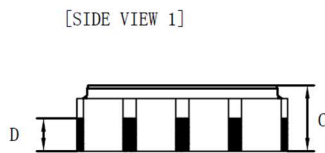

unit:
mm

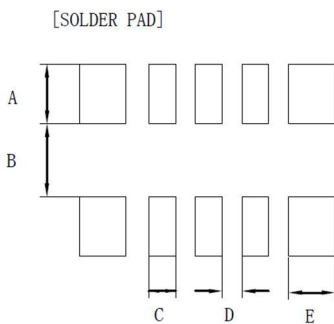

Dimension	Recommend
A	0.9
B	1.1
C	0.4
D	0.3
E	0.7

unit: mm

Note: The metal surface on the side shown in the figure is used for crystal test. Please avoid short circuit caused by contact between the metal surface and other electrical networks or other device surfaces during design and assembly.

Figure 4. Recommended Solder Pad and Dimensions



10 Package

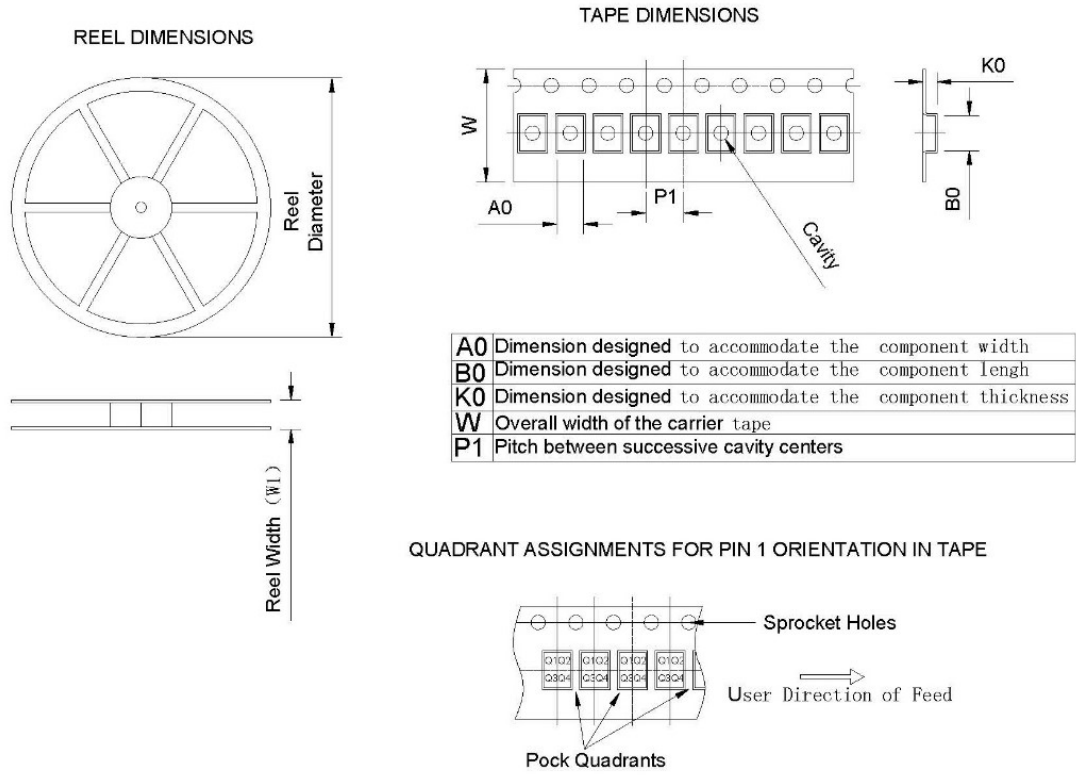

A0	Dimension designed to accommodate the component width
B0	Dimension designed to accommodate the component length
K0	Dimension designed to accommodate the component thickness
W	Overall width of the carrier tape
P1	Pitch between successive cavity centers

QUADRANT ASSIGNMENTS FOR PIN 1 ORIENTATION IN TAPE

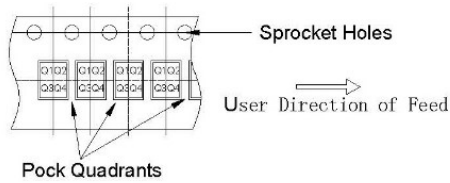

Device	Package Type	Pins	SPQ	Reel Diameter (mm)	Reel Width W1(mm)	A0 (mm)	B0 (mm)	K0 (mm)	P1 (mm)	W (mm)	PIN1 Quadrant
INS5A8804	Ceramic	10	3000	180	11.6±2.0	3.00	3.70	1.50	4	8.00	Q1

Figure 5. Package