

To Customer: _____

Realtime Clock Module

INS5T8900

Datasheet

Document Version 1.0

Released on May 24th, 2024

Ordering Information

Manufacture Part Number	Product Name	Description
INS5T8900-3BEY000Y00CA	INS5T8900	± 5ppm@-40°C~+85°C, 0.55uA(Typ), Ceramics 3225
INS5T8900-3BEY000Y00SA	INS5T8900	± 5ppm@-40°C~+85°C, 0.55uA(Typ), LGA 3225
INS5T8900-3BEX000Y00CA	INS5T8900	± 3ppm@-40°C~+85°C, 0.55uA(Typ), Ceramics 3225
INS5T8900-3BEX000Y00SA	INS5T8900	± 3ppm@-40°C~+85°C, 0.55uA(Typ), LGA 3225
INS5T8900-3BZY000Y00CA	INS5T8900	± 5ppm@-40°C~+85°C ± 8ppm @85°C~105°C, 0.55uA(Typ), Ceramics 3225
INS5T8900-3BZY000Y00SA	INS5T8900	± 5ppm@-40°C~+85°C ± 8ppm @85°C~105°C, 0.55uA(Typ), LGA 3225

Guangdong Dapu Telecom Technology Co., Ltd

Bldg 5, SSL Modern Enterprise Accelerator Zone, Dongguan City, Guangdong Province, PRC China

TEL:0086-0769-88010888

FAX:0086-0769-81800098

Index

1	OVERVIEW	4
2	KEY FEATURES	4
3	BLOCK DIAGRAM	4
4	PIN DEFINITION	5
5	ELECTRICAL CHARACTERISTICS	6
5.1	ABSOLUTE MAXIMUM RATINGS	6
5.2	RECOMMENDED OPERATING CONDITIONS.....	6
5.3	FREQUENCY CHARACTERISTICS	6
5.4	DC CHARACTERISTICS	7
5.5	AC CHARACTERISTICS.....	9
6	REGISTERS	10
6.1	REGISTER LISTS	10
6.2	DETAILS OF REGISTERS.....	11
6.2.1	<i>Clock counter registers</i>	11
6.2.2	<i>Alarm registers</i>	13
6.2.3	<i>Timer control registers</i>	13
6.2.4	<i>Extension registers</i>	14
6.2.5	<i>Flag registers</i>	14
6.2.6	<i>Control registers</i>	15
6.2.7	<i>Temperature register</i>	15
6.2.8	<i>Battery Backup switchover register</i>	15
6.2.9	<i>Device ID register</i>	16
6.2.10	<i>Sub-second timer register</i>	16
7	I²C BUS INTERFACE	17
7.1	CAUTIONS.....	17
7.2	SLAVE ADDRESS	17
7.3	I ² C BUS PROTOCOL	17
7.3.1	<i>Write process</i>	17

7.3.2	Read process.....	18
8	REFLOW SOLDERING CURVE.....	19
9	DIMENSIONS.....	20
10	PACKAGE.....	22
11	REVISION HISTORY.....	24

DAPU Confidential
FOR dptel

1 Overview

INS5T8900 is a high-accuracy I²C bus interface real-time clock with low power consumption. It embeds a 32.768KHz TCXO. The high precise temperature sensor and temperature compensated circuit ensure the high clock accuracy. It supports calendar (year, month, day, hour, minute, second), clock and timer functions etc.

2 Key Features

- Low current consumption: 550nA (Typ.)
- High stability:
±5ppm @ -40°C~85°C; ±3ppm @ -40°C~85°C;
±8ppm @ 85°C~105°C;
- Build-in TCXO: 32.768KHz
- Build-in temperature sensor
- Communication Interface: I²C bus
- Power Supply Voltage: 1.6V~5.5V
- Operation Temperature Range: -40°C ~ +85°C
- Leap years autocorrection
- Backup battery switchover function
- Timer output function with adjustable period
- Size:3.2mm × 2.5mm × 0.9mm
- RoHS2.0, REACH & Halogen-free compliant

3 Block Diagram

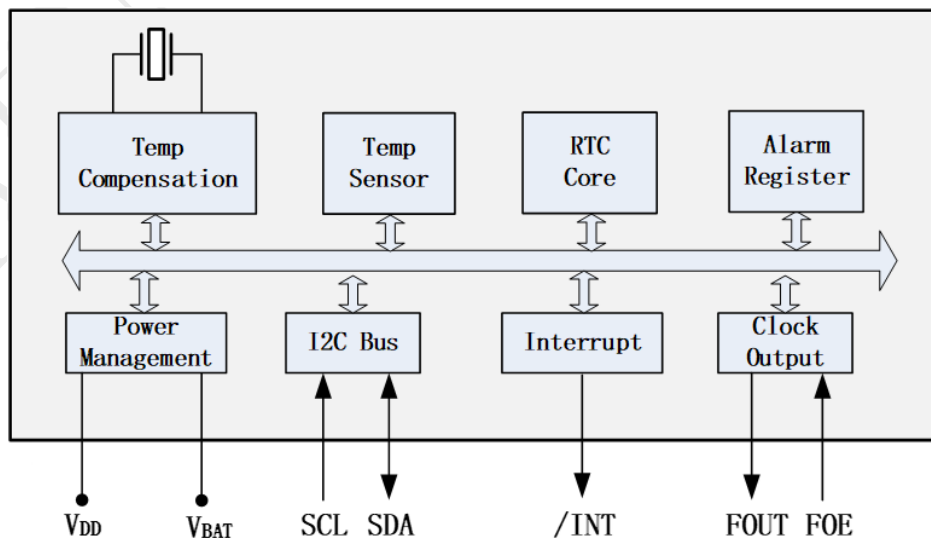

Figure1. Block Diagram

4 Pin definition

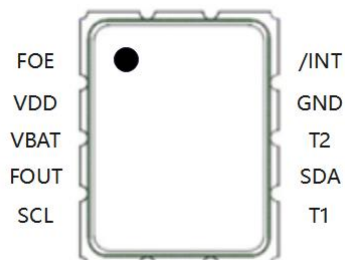

Table1. Pin Definition

Pin Number	Pin Name	I/O	Description
1	FOE	In	FOUT output control pin. "1" - enable FOUT, "0"- FOUT Hi-Z
2	V _{DD}	-	Power supply
3	V _{BAT}	-	Backup battery pin. Connect to large-capacity capacitors or a backup battery. Connect to V _{DD} when switchover function is not necessary
4	FOUT	Out	Frequency output. Controlled by FOE. Frequency can be set by FSEL bits.
5	SCL	In	I ² C clock signal
6	T1	-	Manufacturer test only. Ensure to be floating
7	SDA	In/Out	I ² C data signal
8	T2	-	Manufacturer test only. Ensure to be floating
9	GND	-	Ground
10	/INT	Out	Interrupt Output, Open-Drain

5 Electrical Characteristics

5.1 Absolute Maximum Ratings

Table2. Absolute Maximum Ratings

Parameter	Symbol	Value			Unit	Notes
		Min.	Typ.	Max.		
Power Supply Voltage	V _{DD}	-0.3		6.5	V	
Backup Battery Voltage	V _{BAT}	-0.3		6.5	V	
Input Voltage	V _{IN}	GND-0.3		6.5	V	FOE, SCL, SDA
Clock Output Voltage	V _{OUT1}	GND-0.3		V _{DD} +0.3	V	FOUT
Output Voltage	V _{OUT2}	GND-0.3		6.5	V	SDA, /INT
Storage temperature	T _{STG}	-55		125	°C	

5.2 Recommended Operating Conditions

Table3. Recommended Operating Conditions

Parameter	Symbol	Value			Unit	Notes
		Min.	Typ.	Max.		
Power Supply Voltage (Power on)	V _{DD}	2.5	3.0	5.5	V	*
Power Supply Voltage (Normal mode)	V _{DD}	1.6	3.0	5.5	V	
Power Supply Voltage (Backup mode)	V _{BAT}	1.6	3.0	5.5	V	
Current consumption	I _{DD}		0.55		uA	Using Battery supply only, @25°C
Operation temperature	T _{OPR}	-40	25	105	°C	

*Note:

1. During the power on and oscillation starting time, a voltage of more than 2.5V must be provided to ensure the oscillation circuit to a stable state.
2. After the power supply is removed or power off, ensure that VDD=GND for more than 10 seconds before next power on cycle.
3. If there is no special indication, the test conditions are GND =0V, VDD=1.6V~5.5V, Ta=-40°C~+105°C

5.3 Frequency Characteristics

Table4. Frequency Characteristics

Parameter	Symbol	Value			Unit	Notes
		Min.	Typ.	Max.		
Frequency stability	$\Delta f/f$	$\pm 3\text{ppm @ } -40^\circ\text{C} \sim +85^\circ\text{C}$				3BEX000Y00CA 3BEX000Y00SA
		$\pm 5\text{ppm @ } -40^\circ\text{C} \sim +85^\circ\text{C}$				3BEY000Y00CA 3BEY000Y00SA
		$\pm 5\text{ppm @ } -40^\circ\text{C} \sim +85^\circ\text{C}$ $\pm 8\text{ppm @ } 85^\circ\text{C} \sim +105^\circ\text{C}$				3BZY000Y00CA 3BZY000Y00SA
Oscillation start	t _{STA}			1	s	@25°C, VDD=3V

Parameter	Symbol	Value			Unit	Notes
		Min.	Typ.	Max.		
time						
Year Aging	f_a	-5		+5	ppm	@25°C, First year
Temperature Sensor Accuracy	T_{emp}	-5		+5	°C	$V_{DD}=3.0V$
FOUT duty cycle	t_w/t	40	50	60	%	

Note:

If there is no special indication, the test conditions are $GND = 0V$, $V_{DD} = V_{BAT} = 1.6V \sim 5.5V$, $T_a = -40^{\circ}C \sim +105^{\circ}C$

5.4 DC Characteristics

Table5. DC Characteristics

Parameter	Symbol	Value			Unit	Notes	
		Min.	Typ.	Max (105°C)			
Average Current consumption1	I_{DD1}		0.6	15	uA	$V_{DD}=5.0V$ $T_a=105^{\circ}C$	$f_{SCL}=0Hz$, $FOE=GND$, $/INT = V_{DD}$; $V_{DD}=V_{BAT}$; FOUT off (High-Z); Compensation interval 2s; VDD voltage detection time 2ms
Average Current consumption2	I_{DD2}		0.55	12			
Average Current consumption3	I_{DD3}		3	18	uA	$V_{DD}=5.0V$ $T_a=105^{\circ}C$	$f_{SCL}=0Hz$, $FOE=V_{DD}$, $/INT = V_{DD}$; $V_{DD}=V_{BAT}$; FOUT:32.768kHz, $CL=0pF$; Compensation interval 2s; V_{DD} voltage detection time 2ms
Average Current consumption4	I_{DD4}		1.5	15			
Voltage Low Detection	V_{low}	0.8	1.1	1.4	V		
VDD Voltage Detection	V_{det}	1.8	2.1	2.4	V		
High-level input voltage	V_{IH}	$0.8 \cdot V_{DD}$		5.5	V	SCL, SDA, FOE pin	
Low-level input voltage	V_{IL}	$GND-0.3$		$0.2 \cdot V_{DD}$	V		
High-level output voltage	V_{OH1}	4.0		5.0	V	$V_{DD}=5.0V$, $I_{OH} = -1mA$	FOUT pin
	V_{OH2}	2.2		3.0		$V_{DD}=3.0V$, $I_{OH} = -1mA$	
	V_{OH3}	2.9		3.0		$V_{DD}=3.0V$, $I_{OH} = -100uA$	
Low-level output voltage	V_{OL1}	GND		$GND+0.5$	V	$V_{DD}=5.0V$, $I_{OL} = 1mA$	FOUT pin
	V_{OL2}	GND		$GND+0.8$		$V_{DD}=3.0V$, $I_{OL} = 1mA$	
	V_{OL3}	GND		$GND+0.1$		$V_{DD}=3.0V$, $I_{OL} = 100uA$	
	V_{OL4}	GND		$GND+0.25$	V	$V_{DD}=5.0V$, $I_{OL} = 1mA$	/INT pin
	V_{OL5}	GND		$GND+0.4$		$V_{DD}=3.0V$, $I_{OL} = 1mA$	
	V_{OL6}	GND		$GND+0.4$		$V_{DD} \geq 3.0V$, $I_{OL} = 3mA$	
Input leakage current	I_{LK}	-0.5		0.5	uA	FOE, SDA, SCL pin, $V_{IN} = V_{DD}$ or GND	

Parameter	Symbol	Value			Unit	Notes
		Min.	Typ.	Max (105°C)		
Output leakage current	I _{oz}	-0.5		0.5	uA	FOUT, SDA, /INT pin, V _{IN} = V _{DD} or GND

Note: If there is no special indication, the test conditions are GND=0V, VDD=1.6V~5.5V, Ta=-40°C~+105°C.

FOR dptel

5.5 AC Characteristics

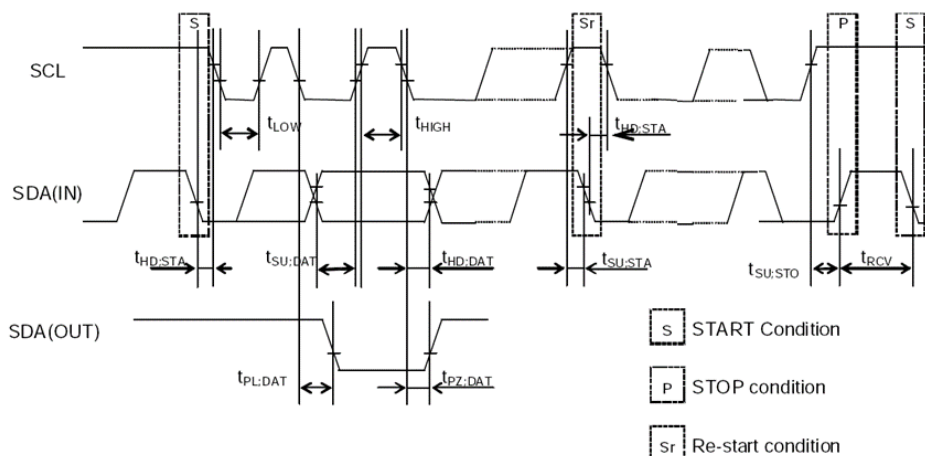

Figure2. I2C bus Timing Chart

Table6. AC Characteristics

$V_{DD}=2.5V \sim 5.5V$; $T_a=-40^{\circ}C \sim +105^{\circ}C$

Parameter	Symbol	Value			Unit
		Min.	Typ.	Max.	
SCL clock frequency	f_{SCL}			400	kHz
SCL low level time	t_{LOW}	1.3			us
SCL high level time	t_{HIGH}	0.6			us
Start condition setup time	$t_{HD:STA}$	0.6			us
Start condition hold time	$t_{SU:STA}$	0.6			us
Stop condition setup time	$t_{SU:STO}$	0.6			us
Bus idle time between start condition and stop condition	t_{RCV}	1.3			us
Data setup time	$t_{SU:DAT}$	100			ns
Data hold time	$t_{HD:DAT}$	0			ns
SCL, SDA rising time	t_r			0.3	us
SCL, SDA falling time	t_f			0.3	us

Note: when the master accesses the equipment through I2C bus, all communication from sending start condition to sending stop shall be completed within 1 second. If it exceeds 1 second, the I2C bus interface will be reset through the internal bus timeout function.

6 Registers

6.1 Register Lists

Table7. Basic Time and Calendar Registers

Address	Function	bit7	bit6	bit5	bit4	bit3	bit2	bit1	bit0	R/W
0x00 0x10	SEC	○	BCD code, Second tens place, 0-5			BCD code, Second ones place, 0-9				R/W
0x01 0x11	MIN	○	BCD code, Minute tens place, 0-5			BCD code, Minute ones place, 0-9				R/W
0x02 0x12	HOUR	○	○	BCD code, Hour tens place, 0-2		BCD code, Hour ones place, 0-9				R/W
0x03 0x13	WEEK	○	6	5	4	3	2	1	0	R/W
0x04 0x14	DAY	○	○	BCD code, Day tens place, 0-3		BCD code, Day ones place, 0-9				R/W
0x05 0x15	MONTH	○	○	○	BCD code, Month tens place, 0-1	BCD code, Month ones place, 0-9				R/W
0x06 0x16	YEAR	BCD code, Year tens place, 0-9				BCD code, Year ones place, 0-9				R/W
0x07	RAM	●	●	●	●	●	●	●	●	R/W
0x08	MIN Alarm	AE	BCD code, Minute tens place, 0-5			BCD code, Minute ones place, 0-9				R/W
0x09	HOUR Alarm	AE	●	BCD code, Hour tens place, 0-2		BCD code, Hour ones place, 0-9				R/W
0x0A	WEEK Alarm	AE	6	5	4	3	2	1	0	R/W
	DAY Alarm		●	BCD code, Day tens place, 0-3		BCD code, Day ones place, 0-9				R/W
0x0B 0x1B	Timer Counter 0	128	64	32	16	8	4	2	1	R/W
0x0C 0x1C	Timer Counter 1	●	●	●	●	2048	1024	512	256	R/W
0x0D 0x1D	Extension Register	TEST	WADA	USEL	TE	FSEL [1]	FSEL [0]	TSEL [1]	TSEL [0]	R/W
0x0E 0x1E	Flag Register	○	○	UF	TF	AF	○	VLF	VDET	R/W
0x0F 0x1F	Control Register	CSEL [1]	CSEL [0]	UIE	TIE	AIE	○	○	RESET	R/W

Table8. Extended Register Group 1

Address	Function	bit7	bit6	bit5	bit4	bit3	bit2	bit1	bit0	R/W
0x17	TEMP	128	64	32	16	8	4	2	1	R

Address	Function	bit7	bit6	bit5	bit4	bit3	bit2	bit1	bit0	R/W
0x18	Backup Function	○	○	○	○	VDET OFF	SWOFF	BKSMP [1]	BKSMP [0]	R/W

Table9. Extended Register Group2

Address	Function	bit7	bit6	bit5	bit4	bit3	bit2	bit1	bit0	R/W
0x20	Device ID	Vendor ID[3:0]				Ver[3:0]				R
0x21	Control Register 1	Reserved							VBAT_SW	R/W
0x27	SubSEC	Reserved				SubSEC[3:0]				R

Note:

1, After power-up reset or in case VLF bit returns “1”, make sure to initialize all registers to default state before using the RTC. Ensure all inputs are in the required range and the defined values are set for the reserved bits in case the clock cannot work normally.

- ✓ During the initial power-up, below bits will be in the state as below:
 Initial 0: TEST, WADA, USEL, TE, FSEL[1:0], TSEL[0], UF, TF, AF, CSEL[1], UIE, TIE, RESET, VDETOFF, SWOFF, BKSMP[1:0], VBAT_SW.
 Initial 1: VLF, VDET, CSEL[0].
- ✓ All other register values are undefined, so make sure to reset the module before using it.
- ✓ The bits marked with “○” can be read out “0” only after initializing.
- ✓ The bits marked with “●” are RAM bits which can be used to write or read any data.
- ✓ Only 0 can be written to UF, TF, AF, VLF, VDET bits.
- ✓ Make sure “0” to be written for TEST bits which are used for testing only.
- ✓ Reserved bits are forbidden to write.

6.2 Details of Registers

6.2.1 Clock counter registers

Address	Function	bit7	bit6	bit5	bit4	bit3	bit2	bit1	bit0	Default
0x00 0x10	SEC	○	BCD code, Second tens place, 0-5			BCD code, Second ones place, 0-9				0x00
0x01 0x11	MIN	○	BCD code, Minute tens place, 0-5			BCD code, Minute ones place, 0-9				0x00
0x02 0x12	HOUR	○	○	BCD code, Hour tens place, 0-2		BCD code, Hour ones place, 0-9				0x00

SEC: BCD format, Value: 0~59

MIN: BCD format, Value: 0~59

HOUR: BCD format, Value: 0~23

Address	Function	bit7	bit6	bit5	bit4	bit3	bit2	bit1	bit0	Default
0x03 0x13	WEEK	○	6	5	4	3	2	1	0	0x40

WEEK: Value 01h, 02h, 04h, 08h, 10h, 20h, 40h. Only one bit can be set to 1 each time, all others must be set to 0.

Table10. WEEK Register

WEEK	Data	bit7	bit6	bit5	bit4	bit3	bit2	bit1	bit0
Sunday	01h	0	0	0	0	0	0	0	1
Monday	02h	0	0	0	0	0	0	1	0
Tuesday	04h	0	0	0	0	0	1	0	0
Wednesday	08h	0	0	0	0	1	0	0	0
Thursday	10h	0	0	0	1	0	0	0	0
Friday	20h	0	0	1	0	0	0	0	0
Saturday	40h	0	1	0	0	0	0	0	0

Address	Function	bit7	bit6	bit5	bit4	bit3	bit2	bit1	bit0	Default
0x04 0x14	DAY	○	○	BCD code, Day tens place, 0-3		BCD code, Day ones place, 0-9				0x01

DAY: BCD format, the value range will be adjusted automatically according to the month setting and if a leap year or not .

Table11. DAY Register Value

Month	Day Value Range
1, 3, 5, 7, 8, 10, 12	1~31
4, 6, 9, 11	1~30
February in normal year	1~28
February in leap year	1~29

Address	Function	bit7	bit6	bit5	bit4	bit3	bit2	bit1	bit0	Default
0x05 0x15	MONTH	○	○	○	BCD code, Month tens place, 0-1	BCD code, Month ones place, 0-9				0x01
0x06 0x16	YEAR	BCD code, Year tens place, 0-9				BCD code, Year ones place, 0-9				0x00

MONTH: BCD format, Value1~12

YEAR: BCD format, Value0~99(2000~2099)

Example: 2020/01/01 Wednesday 21:18:36

Address	Function	bit7	bit6	bit5	bit4	bit3	bit2	bit1	bit0
0x00 0x10	SEC	○	0	1	1	0	1	1	0
0x01 0x11	MIN	○	0	0	1	1	0	0	0
0x02 0x12	HOURL	○	○	1	0	0	0	0	1

Address	Function	bit7	bit6	bit5	bit4	bit3	bit2	bit1	bit0
0x03 0x13	WEEK	○	0	0	0	1	0	0	0
0x04 0x14	DAY	○	○	0	0	0	0	0	1
0x05 0x15	MONTH	○	○	○	0	0	0	0	1
0x06 0x16	YEAR	0	0	1	0	0	0	0	0

6.2.2 Alarm registers

Address	Function	bit7	bit6	bit5	bit4	bit3	bit2	bit1	bit0	Default
0x08	MIN Alarm	AE	BCD code, Minute tens place, 0-5			BCD code, Minute ones place, 0-9				0x00
0x09	HOUR Alarm	AE	●	BCD code, Hour tens place, 0-2		BCD code, Minute ones place, 0-9				0x00
0x0A	WEEK Alarm	AE	6	5	4	3	2	1	0	0x00
	DAY Alarm		●	BCD code, Day tens place, 0-3		BCD code, Day ones place, 0-9				
0x0E 0x1E	Flag Register	○	○	UF	TF	AF	○	VLF	VDET	0x03
0x0F 0x1F	Control Register	CSEL [1]	CSEL [0]	UIE	TIE	AIE	○	○	RESET	0x40

According to AIE, AF, WADA bits setting, the alarm interrupt will be generated once the current time match the settings in the above registers, the /INT pin goes to low level and AF bit is set to '1' to record an alarm interrupt event has occurred.

WEEK Alarm/DAY Alarm: Controlled by WADA bit in 0x0D register.

AE: Alarm Enable bit, 0-enable; 1-disable.

AF: Defined in 0x0E register bit3.

AIE: Defined in 0x0F register bit3.

6.2.3 Timer control registers

Address	Function	bit7	bit6	bit5	bit4	bit3	bit2	bit1	bit0	Default
0x0B 0x1B	Timer Counter 0	128	64	32	16	8	4	2	1	0x00
0x0C 0x1C	Timer Counter 1	●	●	●	●	2048	1024	512	256	0x00
0x0D 0x1D	Extension Register	TEST	WADA	USEL	TE	FSEL[1:0]		TSEL[1:0]		0x02
0x0E 0x1E	Flag Register	○	○	Reserved	TF	Reserved	○	Reserved		0x03
0x0F	Control Register	CSEL	CSEL	UIE	TIE	AIE	○	○	RESET	0x40

Address	Function	bit7	bit6	bit5	bit4	bit3	bit2	bit1	bit0	Default
0x1F		[1]	[0]							

According to TE, TF, TIE, TSEL[1:0] bits setting, a timer interrupt will be generated once the value counts down to 0 from the one set in the above registers.

TE: Defined in 0x0D register bit4

TF: Defined in 0x0E register bit4.

TIE: Defined in 0x0F register bit4.

TSEL[1:0]: Defined in 0x0D register bit1 and bit0

Timer Counter: Preset values of timer counter.

6.2.4 Extension registers

Address	Function	bit7	bit6	bit5	bit4	bit3	bit2	bit1	bit0	Default
0x0D	Extension Register	TEST	WADA	USEL	TE	FSEL[1]	FSEL[0]	TSEL[1]	TSEL[0]	0x02
0x1D										

TEST: Test bit, must be set to “0”

WADA: Week Alarm/Day Alarm control bit, decide 0x0A register as DAY Alarm or WEEK Alarm. 0-WEEK alarm, 1-DAY alarm

USEL: Update Interrupt Select bit, 0-output interrupt once a second, 1-output interrupt once a minute

TE: Timer Enable bit, 0-disable, 1-enable

FSEL[1], FSEL[0]: FOUT frequency setting:

FSEL[1]	FSEL[0]	FOUT Frequency
0	0	32.768KHz (Default)
0	1	1024Hz
1	0	1Hz
1	1	32.768KHz

TSEL[1], TSEL[0]: Timer countdown period(source clock) setting:

TSEL[1]	TSEL[0]	Source clock
0	0	4096Hz
0	1	64Hz
1	0	1Hz
1	1	1/60Hz

6.2.5 Flag registers

Address	Function	bit7	bit6	bit5	bit4	bit3	bit2	bit1	bit0	Default
0x0E 0x1E	Flag Register	○	○	UF	TF	AF	○	VLF	VDET	0x03

UF: Update flag bit. When time update interrupt event occurs, it will be set to “1” and keeps “1” until a “0” is written to it.

TF: Timer Flag bit. When a fixed-cycle timer interrupt event occurs, it will be set to “1” and keeps “1” until a “0” is written to it.

AF: Alarm Flag bit. When an alarm interrupt event occurs, it will be set to “1” and keeps “1” until a “0” is written to it.

VLF: Voltage Low Flag bit. When V_{CORE} (Chip internal voltage) is lower than V_{low}, it will be set to “1” and keeps “1” until a “0” is written to it.

VDET: Voltage Detection Flag bit. When V_{DD} is lower than V_{det}, it will be set to “1” and keeps “1” until a “0” is written to it.

6.2.6 Control registers

Address	Function	bit7	bit6	bit5	bit4	bit3	bit2	bit1	bit0	Default
0x0F	Control	CSEL	CSEL	UIE	TIE	AIE	○	○	RESET	0x40
0x1F	Register	[1]	[0]							

CSEL[1], CSEL[0]: Compensation interval Select 1, 0 bits, used to set temperature compensation interval.

CSEL[1]	CSEL[0]	Compensation interval
0	0	0.5s
0	1	2s(default)
1	0	10s
1	1	30s

UIE: Update Interrupt Enable bit. When UF changes from “0” to “1”, this bit controls if an interrupt signal is generated. 0-disable (/INT keeps Hi-Z), 1-enable (/INT status changes from Hi-Z to Low).

TIE: Timer Interrupt Enable bit: When TF changes from “0” to “1”, this bit controls if an interrupt signal is generated. 0-disable (/INT keeps Hi-Z), 1-enable (/INT status changes from Hi-Z to Low).

AIE: Alarm Interrupt Enable bit: When AF changes from “0” to “1”, this bit controls if an interrupt signal is generated. 0-disable (/INT keeps Hi-Z), 1-enable (/INT status changes from Hi-Z to Low).

RESET: Reset IC, prepared for the synchronized starting of time or timer.

6.2.7 Temperature register

Address	Function	bit7	bit6	bit5	bit4	bit3	bit2	bit1	bit0	Default
0x17	TEMP	128	64	32	16	8	4	2	1	0x00

$$\text{Temperature}[^{\circ}\text{C}] = (\text{TEMP}[7:0] * 2 - 187.19) / 3.218 \quad \text{3BEY000Y00CA} / \text{3BEY000Y00SA}$$

6.2.8 Battery Backup switchover register

Address	Function	bit7	bit6	bit5	bit4	bit3	bit2	bit1	bit0	Default	
0x18	Backup Function	○	○	○	○	VDET OFF	Swoff	BKSMP [1]	BKSMP [0]	0x00	
0x21	Control Register 1	Reserved:							VBAT_SW		0x00

This register controls the power switchover function. Once abnormal V_{DD} is detected, it will be switched to use battery as the power supply.

VDETOFF (Voltage Detector OFF): Main power supply V_{DD} voltage detection control bit. 0-enable detection function (Default), V_{DD} voltage will be detected once a second; 1-disable detection function.

Swoff (Switch OFF): SW1 control bit. 0- SW1 controlled by swsel[1:0], 1- SW1 turn on.

BKSMP[1:0] (Backup mode Sampling time): Control the voltage detection sampling time. Default: 00.

VBAT_SW: K2 Switch control bit between VBAT and V_{CORE}. Default 0, 0-K2 is open. 1- K2 is close.

Table12. V_{DD} Voltage Sampling Time

VDD Detect Function	VDETOFF	SWOFF	VBAT_SW	BKS MP [1]	BKSMP [0]	V _{DD} Voltage Sampling Time	Switch K1 ON/OFF	Switch K2 ON/OFF	Notes
ON	0	X	X	0	0	2ms	2ms OFF		Default
			X	0	1	16ms	16ms OFF		
			X	1	0	128ms	128ms OFF		
			X	1	1	256ms	256ms OFF		
OFF	1	0	0	X	X	OFF	ON	OFF	SW1 Close
		0	1	X	X	OFF	ON	ON	SW1/SW2 Close
		1	X	X	x	OFF	OFF	ON	SW1 Open

6.2.9 Device ID register

Address	Function	bit7	bit6	bit5	bit4	bit3	bit2	bit1	bit0	Default
0x20	Device ID	VendorID[3:0]				Ver[3:0]				0xD1

VendorID[3:0]: The fixed value is defined as VendorID[3:0]=1101b=Dh to represent DAPU.

Ver[3:0]: version of the IC

6.2.10 Sub-second timer register

Address	Function	bit7	bit6	bit5	bit4	bit3	bit2	bit1	bit0	Default
0x27	SubSEC	Reserved				SubSEC[3:0]				0x00

SubSEC[3:0]: sub second bit, and unit is 1/16s.

7 I²C Bus Interface

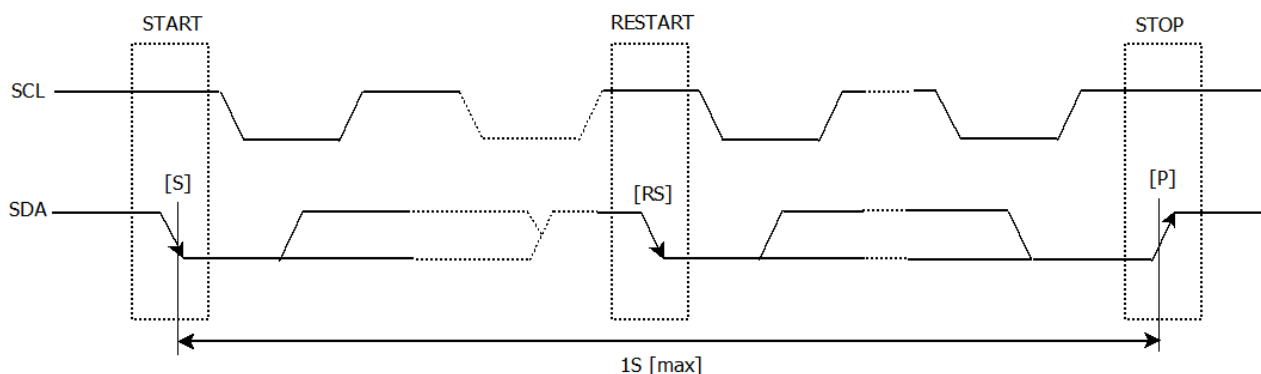

I²C bus supports bi-directional communications through a serial clock line SCL and a serial data line SDA. I²C bus device can be defined as “Master” and “Slave”. INS5T8900 can only be used as Slave.

7.1 Cautions

I²C bus includes START, RESTART, STOP conditions, the duration between START and STOP must be less than 1 second just in case the bus to be set to standby mode automatically. A new START condition must be transferred before restarting of any communications.

INS5T8900 I²C bus interface supports single byte read/write operations as well as multiple bytes incremental access. After 0xFF address, the next one will be 0x00.

7.2 Slave Address

Table13. I²C Bus Slave Address

Transfer data	Slave address							R/W
	bit7	bit6	bit5	bit4	bit3	bit2	bit1	bit0
65h (Read)	0	1	1	0	0	1	0	1 (Read)
64h (Write)								0 (Write)

INS5T8900 I²C bus Slave Address is [0110 010*].

7.3 I²C bus protocol

It is assumed CPU is master and INS5T8900 is slave in this section.

7.3.1 Write process

I²C bus includes an address auto-increment function, once the initial address has been specified, the INS5T8900 increments (+1) the address automatically after each data is sent, then to write next data.

- (1) CPU sends start condition[S]
- (2) CPU sends INS5T8900's slave address with R/W bit to set to write mode
- (3) CPU verifies ACK signal from INS5T8900
- (4) CPU sends write address to INS5T8900
- (5) CPU verifies ACK signal from INS5T8900
- (6) CPU sends write data to the address specified at step (4)
- (7) CPU verifies ACK signal from INS5T8900
- (8) Repeat (6) (7) if multiple bytes need to be written, address will be incremented automatically
- (9) CPU ends stop condition[P]

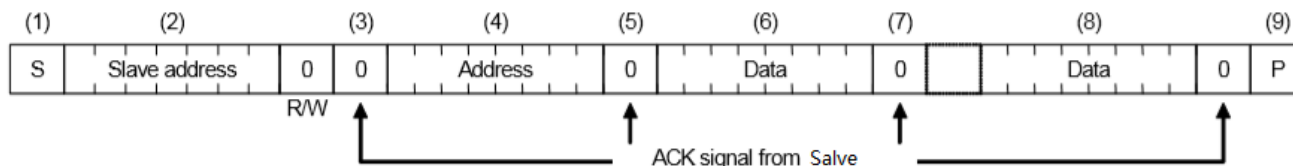

7.3.2 Read process

Writing the address to be read with write mode firstly, then reading the data with read mode.

- (1) CPU sends start condition[S]
- (2) CPU sends INS5T8900's slave address with R/W bit to set to write mode
- (3) CPU verifies ACK signal from INS5T8900
- (4) CPU sends address for reading from INS5T8900
- (5) CPU verifies ACK signal from INS5T8900
- (6) CPU sends RESTART condition [Sr]
- (7) CPU sends INS5T8900's slave address with R/W bit to set to read mode
- (8) CPU verifies ACK signal from INS5T8900
- (9) CPU reads data from the specified address in step (4)
- (10) CPU sends ACK signal for "0"
- (11) Repeat (9) (10) if multiple bytes need to be read, address will be incremented automatically
- (12) CPU sends ACK signal for "1"
- (13) CPU sends stop condition[P]

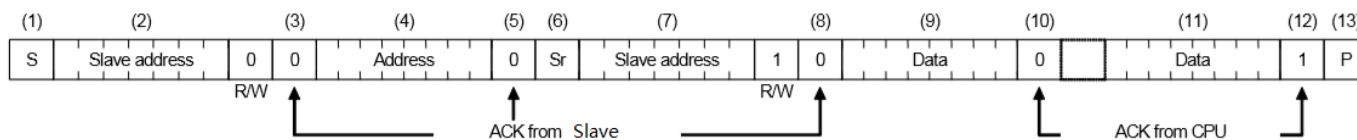

8 Reflow Soldering Curve

Standard: IPC/JEDEC J-STD-020

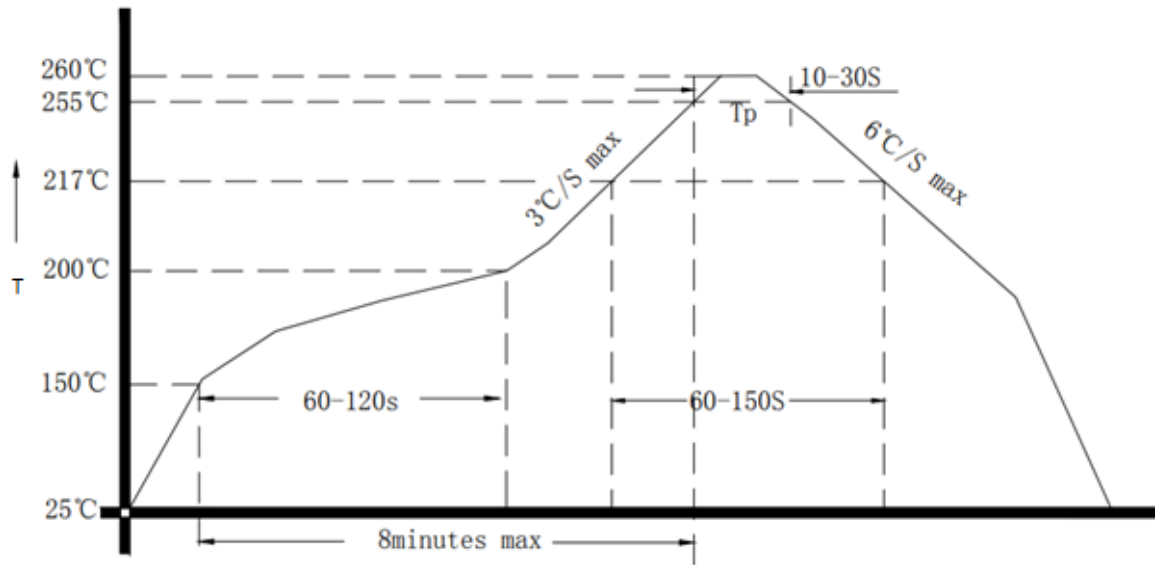

Figure 3. Reflow Soldering Curve

Note: It is suggested to solder IC under the condition shown in the curve above. Must pay attention to the temperature and time when manual soldering, if the temperature over +260°C, or you will make the xo performance bad, even damage it.

FOR dptel

9 Dimensions

MPN: INS5T8900-3BEY000Y00CA / 3BEX000Y00CA / 3BZY000Y00CA

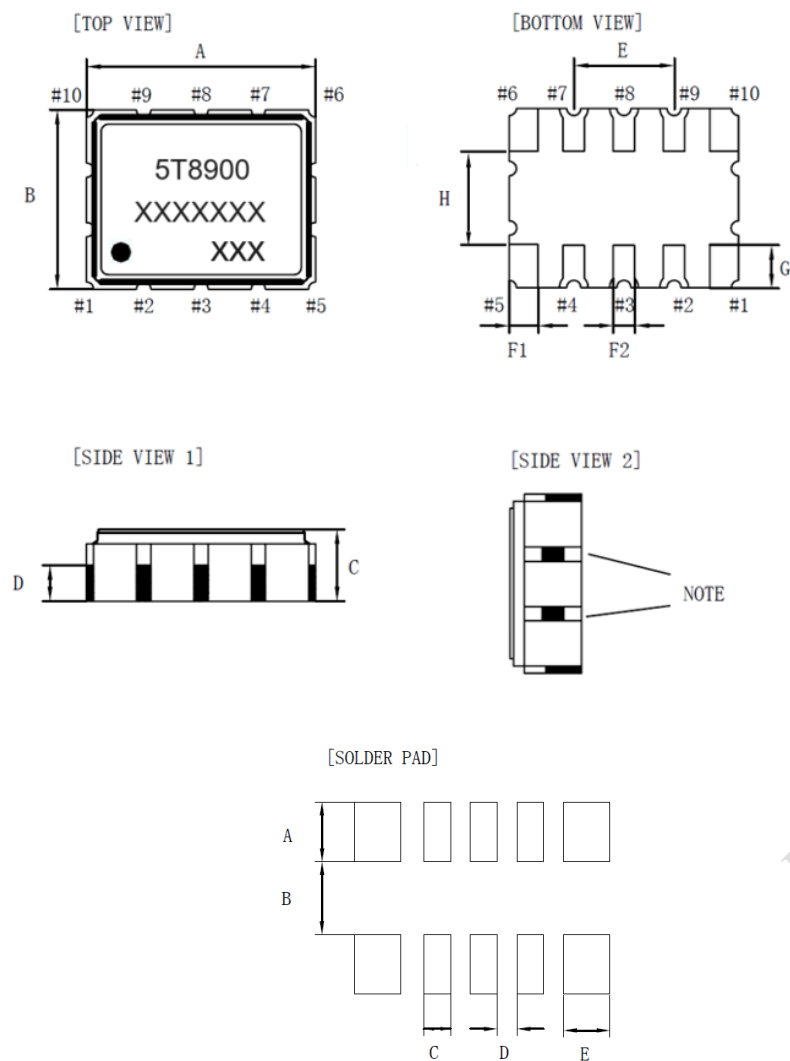

Dimension	Min.	Typ.	Max.
A	3.1	3.2	3.3
B	2.4	2.5	2.6
C	0.8	0.9	1.0
D	--	0.45	--
E	--	1.4	--
F1	--	0.4	--
F2	--	0.3	--
G	--	0.6	--
H	--	1.3	--

unit: mm

Dimension	Recommend
A	0.9
B	1.1
C	0.4
D	0.3
E	0.7

unit: mm

Figure 4. Dimensions and Recommended Solder Pad

Note:

1. The metal surface on the side shown in the figure is used for crystal test. Please avoid short circuit caused by contact between the metal surface and other electrical networks or other device surfaces during design and assembly.
2. The unnoted tolerance is $\pm 0.1\text{mm}$.

MPN: INS5T8900-3BEY000Y00SA / 3BEX000Y00SA / 3BZY000Y00SA

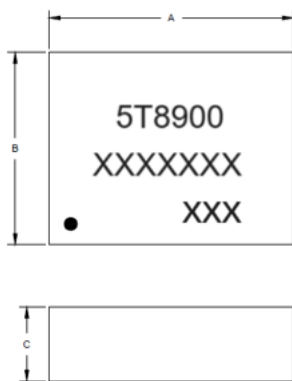

Dimension	Min.	Typ.	Max.
A	3.0	3.2	3.4
B	2.3	2.5	2.7
C	--	1.0	--
E	--	0.3	--
F	--	0.4	--
G	--	0.6	--
H	--	1.3	--
F1	--	0.45	--
F2	--	0.3	--

Unit: mm

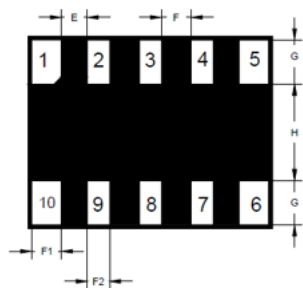
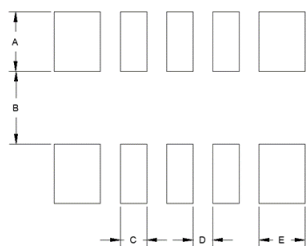

Figure 5. Dimension



Dimension	Max.
A	0.9
B	1.1
C	0.4
D	0.3
E	0.7

Unit: mm

Figure 6. Recommended Soldering Pattern

10 Package

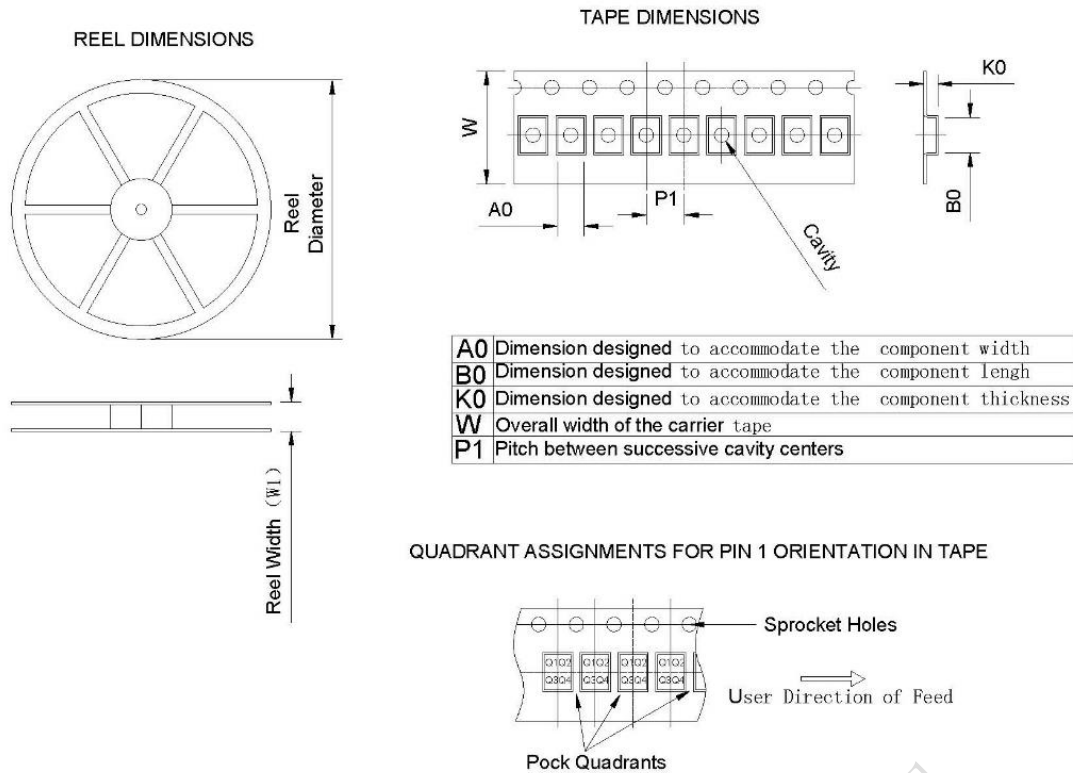

Figure 7. Package

Device	Package Type	Pins	SPQ	Reel Diameter (mm)	Reel Width W1(mm)	A0 (mm)	B0 (mm)	K0 (mm)	P1 (mm)	W (mm)	PIN1 Quadrant
INS5T8900-3BEY000Y00CA	Ceramic	10	3000	180	11.6±2.0	3.00	3.70	1.50	4	8.00	Q1
INS5T8900-3BEX000Y00CA /	Ceramic	10	3000	180	11.6±2.0	3.00	3.70	1.50	4	8.00	Q1
INS5T8900-3BZY000Y00CA /	Ceramic	10	3000	180	11.6±2.0	3.00	3.70	1.50	4	8.00	Q1
INS5T8900-3BEY000Y00SA /	LGA	10	3000	180	11.6±2.0	3.00	3.70	1.50	4	8.00	Q1
INS5T8900-3BEX000Y00SA /	LGA	10	3000	180	11.6±2.0	3.00	3.70	1.50	4	8.00	Q1

INS5T8900- 3BZY000Y00SA /	LGA	10	3000	180	11.6±2.0	3.00	3.70	1.50	4	8.00	Q1
------------------------------	-----	----	------	-----	----------	------	------	------	---	------	----

FOR dptel

11 Revision History

Version	Change Contents	Prepared by	Revised Date
V1.0	First Issued		2024.05.24

FOR dptel