



To Customer: \_\_\_\_\_

# Realtime Clock Module

## INS5T8130

### Datasheet

Document Version 1.2

Released on June 6th, 2024

### Ordering Information

Manufacture Part Number(MPN)	Product Name	Description
INS5T8130CFX	INS5T8130	-120ppm~+10ppm @ -20°C~+70°C <5±23ppm @ 25°C, Ceramic 3225
INS5T8130SFX	INS5T8130	-120ppm~+10ppm @ -20°C~+70°C <5±23ppm @ 25°C, LGA 3225

## Guangdong Dapu Telecom Technology Co., Ltd

Bldg 5, SSL Modern Enterprise Accelerator Zone, Dongguan City, Guangdong Province, PRC China

[TEL:0086-0769-88010888](tel:0086-0769-88010888)

FAX:0086-0769-81800098



# Index

<b>1</b>	<b>OVERVIEW</b> .....	<b>4</b>
<b>2</b>	<b>KEY FEATURES</b> .....	<b>4</b>
<b>3</b>	<b>BLOCK DIAGRAM</b> .....	<b>5</b>
<b>4</b>	<b>PIN DEFINITION</b> .....	<b>5</b>
<b>5</b>	<b>ELECTRICAL CHARACTERISTICS</b> .....	<b>6</b>
5.1	ABSOLUTE MAXIMUM RATINGS .....	6
5.2	RECOMMENDED OPERATING CONDITIONS.....	6
5.3	FREQUENCY CHARACTERISTICS .....	7
5.4	DC CHARACTERISTICS .....	7
5.5	AC CHARACTERISTICS.....	9
<b>6</b>	<b>REGISTERS</b> .....	<b>11</b>
6.1	REGISTER LISTS .....	11
6.2	DETAILS OF REGISTERS.....	12
6.2.1	<i>Clock counter registers</i> .....	12
6.2.2	<i>Alarm registers</i> .....	14
6.2.3	<i>Timer registers</i> .....	14
6.2.4	<i>Extension registers</i> .....	14
6.2.5	<i>Flag registers</i> .....	15
6.2.6	<i>Control registers</i> .....	16
6.2.7	<i>Digital offset register</i> .....	18
6.2.8	<i>Extended register 1</i> .....	19
<b>7</b>	<b>I<sup>2</sup>C BUS INTERFACE</b> .....	<b>20</b>
7.1	CAUTIONS.....	20
7.2	SLAVE ADDRESS .....	20
7.3	I <sup>2</sup> C BUS PROTOCOL .....	20
7.3.1	<i>Write process</i> .....	20
7.3.2	<i>Read process</i> .....	21
<b>8</b>	<b>REFLOW SOLDERING CURVE</b> .....	<b>22</b>



---

9	DIMENSIONS .....	23
10	PACKAGE .....	25
11	REVISION HISTORY .....	26

DAPU Confidential  
FOR 深圳大耳马



# 1 Overview

INS5T8130 is an I<sup>2</sup>C bus interface real-time clock with low power consumption and digital offset function. It supports backup battery and embeds a 32.768KHz XO. It supports calendar (year, month, day, hour, minute, second), clock and timer functions etc. The SMD3225 package with only 1.0mm thickness makes it very suitable to be used in portable and small size electronic devices.

## 2 Key Features

- Low current consumption: 0.9uA (Typ.)
- High stability: < 5±23ppm @ +25°C
- Build-in XO: 32.768KHz
- Communication interface: I<sup>2</sup>C bus
- Power supply voltage: 1.6V~5.5V
- RoHS2.0, REACH & Halogen-free compliant
- Timekeeper voltage: 1.2V~5.5V
- Operation temperature range: -40°C ~ +85°C
- Leap years autocorrection
- Timer output function with adjustable period
- Package: 3.2mm × 2.5mm × 1.0mm
- Digital offset function



### 3 Block Diagram

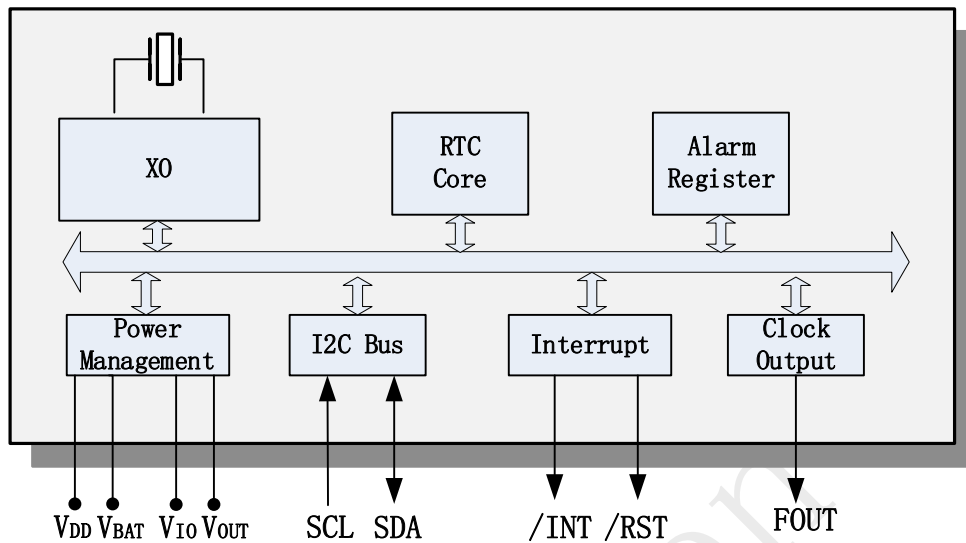

### 4 Pin definition

- |                    |  |                      |
|--------------------|--|----------------------|
| 1. V <sub>IO</sub> |  | 10. V <sub>BAT</sub> |
| 2. SCL             |  | 9. V <sub>OUT</sub>  |
| 3. SDA             |  | 8. V <sub>DD</sub>   |
| 4. FOUT            |  | 7. GND               |
| 5. /RST            |  | 6. /INT              |

**Table1. Pin Definition**

Pin Number	Pin Name	I/O	Description
1	V <sub>IO</sub>	-	Interface power supply pin.
2	SCL	In	I <sup>2</sup> C clock signal
3	SDA	In/Out	I <sup>2</sup> C data signal
4	FOUT	Out	Frequency output. Frequency can be set by FSEL bits.
5	/RST	Out	Reset signal output. After the VDD pressure drop is detected, the pin outputs a negative pulse.
6	/INT	Out	Timing event interrupt output. Open-Drain.



Pin Number	Pin Name	I/O	Description
7	GND	-	Ground
8	V <sub>DD</sub>	-	Power supply
9	V <sub>OUT</sub>	-	Internal voltage output pin. Connect capacitor of 1.0uF to Ground
10	V <sub>BAT</sub>	-	Backup battery pin. V <sub>BAT</sub> cannot floating, connect to large-capacity capacitors or a backup battery. Connect to V <sub>DD</sub> when switchover function is not necessary.

Note: A 0.1μF bypass capacitor is needed at least between power supply pins and GND pin.

Note: Input pins regardless of V<sub>IO</sub> applied voltage. It is able to input up to 5.5V.

Note: Open drain pins regardless of V<sub>IO</sub> applied voltage. It is able to Pull-up to 5.5V

Note: When not use, take the FOUT, /RST, /INT terminals as OPEN

## 5 Electrical Characteristics

### 5.1 Absolute Maximum Ratings

**Table2. Absolute Maximum Ratings**

Parameter	Symbol	Value			Unit	Notes
		Min.	Typ.	Max.		
Power supply voltage	V <sub>DD</sub>	-0.3		6.5	V	
Internal voltage	V <sub>OUT</sub>	-0.3		6.5	V	
Backup battery voltage	V <sub>BAT</sub>	-0.3		6.5	V	
Interface voltage	V <sub>IO</sub>	-0.3		6.5	V	
Input voltage	V <sub>IN</sub>	GND-0.3		6.5	V	SCL, SDA input
Clock output voltage	V <sub>OUT1</sub>	GND-0.3		V <sub>DD</sub> +0.3	V	FOUT output
Output voltage	V <sub>OUT2</sub>	GND-0.3		6.5	V	SDA, /INT output
Storage temperature	T <sub>STG</sub>	-55		125	°C	

### 5.2 Recommended Operating Conditions

**Table3. Recommended Operating Conditions**

Unless otherwise specified, GND=0V, Ta=-40°C~+85°C



Parameter	Symbol	Value			Unit	Notes
		Min.	Typ.	Max.		
Power Supply Voltage (normal mode)	V <sub>DD</sub>	1.2	3.0	5.5	V	
Interface voltage	V <sub>IO</sub>	1.6	3.0	5.5	V	If INIEN = 1, V <sub>DD</sub> <V <sub>DET1</sub> , the interface is disable.
Backup Battery	V <sub>BAT</sub>	1.2	3.0	5.5	V	
Operation temperature	T <sub>OPR</sub>	-40	25	85	°C	

Note 1: To apply Min. value of V<sub>DD</sub>, V<sub>DD</sub> need to be supplied with more than 2.5V at least for the oscillation to stabilize (oscillation start time t<sub>STA</sub>). Please ensure that force the power to V<sub>DD</sub> rather than V<sub>BAT</sub> when first power on.

Note 2: Ensure that the power on time from 0 to V<sub>DD</sub> is less than 100ms

### 5.3 Frequency Characteristics

**Table4. Frequency Characteristics**

Unless otherwise specified, GND=0V, Ta=-40°C~+85°C

Parameter	Symbol	Value			Unit	Notes
		Min.	Typ.	Max.		
Frequency stability	Δf <sub>1</sub> /f	5±23			ppm	V <sub>DD</sub> =3.0V; @+25°C
Frequency stability	Δf <sub>2</sub> /f	-120		+10	ppm	V <sub>DD</sub> =3.0V; -20°C ~ +70°C; Reference frequency @ +25°C
Oscillation start time	t <sub>STA</sub>			1	s	V <sub>DD</sub> =2.5V~5.5V
Year Aging	f <sub>a</sub>			±5	ppm	
FOUT duty cycle	t <sub>w</sub> /t	40	50	60	%	

### 5.4 DC Characteristics

**Table5. DC Characteristics**

Unless otherwise specified, GND=0V, V<sub>BAT</sub>=V<sub>DD</sub>=1.2~5.5V, V<sub>IO</sub>=1.6V ~5.5V, Ta=-40°C~+85°C

Item	Symbol	Value			Unit	Notes
		Min.	Typ.	Max.		
Average Current consumption1	I <sub>DD1</sub>		0.9	5.6	uA	SCL=SDA = 'H', FOUT=OFF, /INT=OFF, V <sub>DD</sub> =V <sub>IO</sub> =3.0V,CHGEN=0b or V <sub>BAT</sub> ≧ V <sub>DET3</sub> , -40°C~85°C
Average Current consumption 2	I <sub>DD2</sub>		3.4	7.8	uA	SCL=SDA = 'H', FOUT=32.768kHz (FOUT pin CL=15pF),



Item	Symbol	Value			Unit	Notes
		Min.	Typ.	Max.		
						/INT=OFF,V <sub>DD</sub> =V <sub>IO</sub> =3.0V, CHGEN=0b or V <sub>BAT</sub> ≧ VDET3,-40°C~85°C
Average Current consumption 3	I <sub>DD3</sub>		1.0	5.0	uA	SCL, SDA = 'L', V <sub>BAT</sub> =3.0V, V <sub>DD</sub> =V <sub>IO</sub> =0V, -40°C~+85°C
Detector Threshold voltage1 (V <sub>DD</sub> rising edge)	+VDET11	2.25	2.6	2.95	V	/RST releases setting:2.6 V
Detector Threshold voltage1 (V <sub>DD</sub> falling edge)	-VDET11	2.20	2.55	2.90	V	/RST output setting:2.6 V
Detector Threshold voltage2 (V <sub>DD</sub> rising edge)	+VDET12	2.20	2.55	2.90	V	/RST releases setting:2.55V
Detector Threshold voltage2 (V <sub>DD</sub> falling edge)	-VDET12	2.15	2.5	2.85	V	/RST output setting:2.55 V
Detector Threshold voltage3 (V <sub>DD</sub> rising edge)	+VDET2	1.22	1.46	1.7	V	Exchange voltage: VBAT to VDD
Detector Threshold voltage3 (V <sub>DD</sub> falling edge)	-VDET2	1.2	1.44	1.68	V	Exchange voltage: VDD to VBAT
Detector Threshold voltage4 (V <sub>BAT</sub> rising edge)	+VDET31	2.77	2.97	3.17	V	Stop charging voltage (full charge) BFVSEL=00b
Detector Threshold voltage4 (V <sub>BAT</sub> falling edge)	-VDET31	2.68	2.90	3.12	V	Recharge voltage. BFVSEL=00b
Detector Threshold voltage5 (V <sub>BAT</sub> rising edge)	+VDET30	2.7	2.88	3.1	V	Stop charging voltage (full charge) BFVSEL=10b
Detector Threshold voltage5 (V <sub>BAT</sub> falling edge)	-VDET30	2.65	2.8	3.00	V	Recharge voltage. BFVSEL=10b
Detector Threshold voltage6 (V <sub>BAT</sub> rising edge)	+VDET32	2.82	3.05	3.28	V	Stop charging voltage (full charge) BFVSEL=01b
Detector Threshold voltage6 (V <sub>BAT</sub> falling edge)	-VDET32	2.72	2.95	3.2	V	Recharge voltage. BFVSEL=01b
V <sub>BAT</sub> off voltage	-VDET4	2.1	2.3	2.6	V	Low V <sub>BAT</sub> detection





Item	Symbol	Value			Unit	Notes	
		Min.	Typ.	Max.			
						VBLF = 1b	
V <sub>DD</sub> -V <sub>OUT</sub> Off-leak current	I <sub>SW1</sub>			15	nA	V <sub>DD</sub> =0V, V <sub>OUT</sub> =3.0V	
V <sub>DD</sub> -V <sub>OUT</sub> Off-leak current	I <sub>SW2</sub>			15	nA	V <sub>OUT</sub> =0V, V <sub>BAT</sub> =3.0V	
V <sub>OUT</sub> output voltage1	V <sub>OUT1</sub>		V <sub>DD</sub> -0.06V		V	V <sub>DD</sub> =3V, I <sub>OUT</sub> =1mA	
V <sub>OUT</sub> output voltage2	V <sub>OUT2</sub>		V <sub>BAT</sub> -0.02V		V	V <sub>BAT</sub> =3.0V, I <sub>OUT</sub> =0.1mA	
Input voltage High-level	V <sub>IH</sub>	0.8*V <sub>IO</sub>		5.5	V	SCL, SDA	
Input voltage Low-level	V <sub>IL</sub>	GND-0.3		0.2*V <sub>IO</sub>	V		
Output voltage High-level	V <sub>OH</sub>	V <sub>IO</sub> -0.5		V <sub>IO</sub>	V	I <sub>OH</sub> = -1mA	FOUT 脚
Output voltage Low-level	V <sub>OL1</sub>	GND		GND+0.5	V	I <sub>OL</sub> = 1mA	FOUT 脚
	V <sub>OL2</sub>	GND		GND+0.25	V	V <sub>IO</sub> =5.0V, I <sub>OL</sub> =1mA	/RST,
	V <sub>OL3</sub>	GND		GND+0.4	V	V <sub>IO</sub> =3.0V, I <sub>OL</sub> =1mA	/INT
	V <sub>OL4</sub>	GND		GND+0.4	V	V <sub>IO</sub> ≥2.0V, I <sub>OL</sub> =3mA	SDA

## 5.5 AC Characteristics

**Table6. AC Characteristics**

Unless otherwise specified, GND =0V, V<sub>IO</sub>=1.6V ~ 5.5V; Ta=-40°C ~ +85°C

Parameter	Symbol	Value			Unit
		Min.	Typ.	Max.	
SCL clock frequency	f <sub>SCL</sub>			400	kHz
SCL low level time	t <sub>LOW</sub>	1.3			us
SCL high level time	t <sub>HIGH</sub>	0.6			us
Start condition setup time	t <sub>HD;STA</sub>	0.6			us
Start condition hold time	t <sub>SU;STA</sub>	0.6			us
Stop condition setup time	t <sub>SU;STO</sub>	0.6			us
Bus idle time between start condition and stop condition	t <sub>RCV</sub>	1.3			us
Data setup time	t <sub>SU;DAT</sub>	100			ns
Data hold time	t <sub>HD;DAT</sub>	0			ns
SCL, SDA rising time	t <sub>r</sub>			0.3	us
SCL, SDA falling time	t <sub>f</sub>			0.3	us

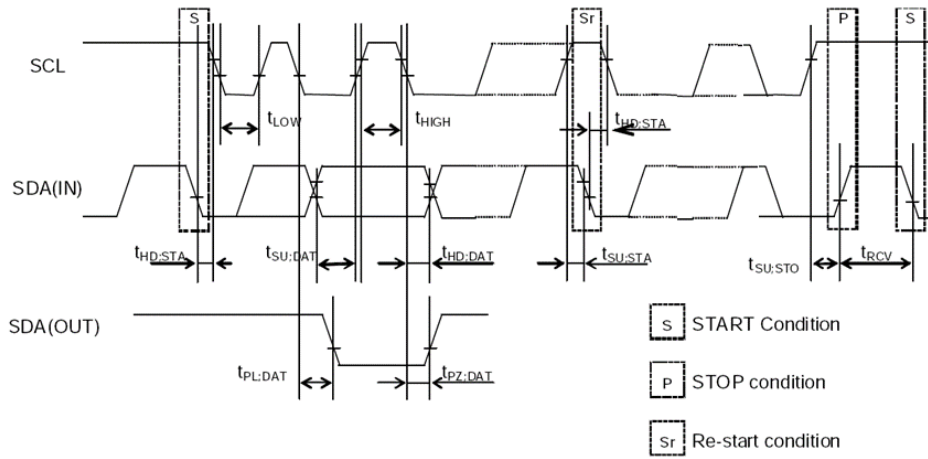

Figure 1. I<sup>2</sup>C bus Timing Chart



## 6 Registers

### 6.1 Register Lists

Address 0x10~0x19: Basic Time and Calendar Registers

Address 0x1A~0x1F: Control、Flags、Extended Register sets

Address 0x20~0x23: RAM register bank

Address 0x30~0x31: Extended register bank 1

**Table7. Basic Time and Calendar Registers**

Address	Function	bit7	bit6	bit5	bit4	bit3	bit2	bit1	bit0	R/W
0x10	SEC	○	BCD code, Second tens place, 0-5			BCD code, Second ones place, 0-9				R/W
0x11	MIN	○	BCD code, Minute tens place, 0-5			BCD code, Minute ones place, 0-9				R/W
0x12	HOUR	○	○	BCD code, Hour tens place, 0-2		BCD code, Hour ones place, 0-9				R/W
0x13	WEEK	○	6	5	4	3	2	1	0	R/W
0x14	DAY	○	○	BCD code, Day tens place, 0-3		BCD code, Day ones place, 0-9				R/W
0x15	MONTH	○	○	○	BCD code, Month tens place, 0-1	BCD code, Month ones place, 0-9				R/W
0x16	YEAR	BCD code, Year tens place, 0-9				BCD code, Year ones place, 0-9				R/W
0x17	MIN Alarm	AE	BCD code, Minute tens place, 0-5			BCD code, Minute ones place, 0-9				R
0x18	HOUR Alarm	AE	●	BCD code, Hour tens place, 0-2		BCD code, Hour ones place, 0-9				R/W
0x19	WEEK Alarm	AE	6	5	4	3	2	1	0	R/W
	DAY Alarm		●	BCD code, Day tens place, 0-3		BCD code, Day ones place, 0-9				R/W
0x1A	Timer Counter 0	128	64	32	16	8	4	2	1	R/W
0x1B	Timer Counter 1	32768	16384	8192	4096	2048	1024	512	256	R/W
0x1C	Extension Register	FSEL[1]	FSEL[0]	USEL	TE	WADA	TSEL[2]	TSEL[1]	TSEL[0]	R/W
0x1D	Flag Register	VBLF	○	UF	TF	AF	RSF	VLF	VBFF	R/W
0x1E	Control Register	TEST	STOP	UIE	TIE	AIE	TSTP	TBKON	TBKE	R/W



Address	Function	bit7	bit6	bit5	bit4	bit3	bit2	bit1	bit0	R/W
0x1F	Control Register	SMP TSEL[1]	SMP TSEL[0]	CHGEN	INIEN	○	RSVSEL	BF VSEL[1]	BF VSEL[0]	R/W
0x20   0x23	RAM	●	●	●	●	●	●	●	●	R/W
0x30	Digital offset	DTE	L7	L6	L5	L4	L3	L2	L1	R/W
0x31	Extension Register1	○	○	○	○	○	○	○	VBLFE	R/W

Note:

1. After power-up reset or in case VLF bit returns “1”, make sure to initialize all registers to default state before using the RTC.
2. During the initial power-up, below bits will be in the state as below:  
 Initial 0: TEST、WADA、USEL、TE、FSEL[1:0]、TSEL[1:0]、UF、TF、AF、UIE、TIE、AIE、TSTP、TBKON、TBKE、DTE、VBLF、VBFF、SMPTSEL[1:0]、CHGEN、INIEN、RSVSEL、BFVSEL[1:0]、VBLFE;  
 Initial 1: VLF、RSF、TSEL[2];
3. All other register values are undefined, so make sure to reset the module before using it.
4. The bits marked with “○” can be read out “0” only after initializing.
5. The bits marked with “●” are RAM bits which can be used to write or read any data.
6. Only 0 can be written to UF, TF, AF, VLF bits.
7. Make sure “0” to be written for TEST bits which are used for testing only.

## 6.2 Details of Registers

### 6.2.1 Clock counter registers

Address	Function	bit7	bit6	bit5	bit4	bit3	bit2	bit1	bit0	Default
0x10	SEC	○	BCD code, Second tens place, 0-5			BCD code, Second ones place, 0-9				0x00
0x11	MIN	○	BCD code, Minute tens place, 0-5			BCD code, Minute ones place, 0-9				0x00
0x12	HOUR	○	○	BCD code, Hour tens place, 0-2		BCD code, Hour ones place, 0-9				0x00

SEC: BCD format, Value: 0~59

MIN: BCD format, Value: 0~59

HOUR: BCD format, Value: 0~23

Address	Function	bit7	bit6	bit5	bit4	bit3	bit2	bit1	bit0	Default
0x13	WEEK	○	6	5	4	3	2	1	0	0x40

WEEK: Value 01h, 02h, 04h, 08h, 10h, 20h, 40h. Only one bit can be set to 1 each time, all others must be set to 0.



**Table8. WEEK Register**

WEEK	Data	bit7	bit6	bit5	bit4	bit3	bit2	bit1	bit0
Sunday	01h	0	0	0	0	0	0	0	1
Monday	02h	0	0	0	0	0	0	1	0
Tuesday	04h	0	0	0	0	0	1	0	0
Wednesday	08h	0	0	0	0	1	0	0	0
Thursday	10h	0	0	0	1	0	0	0	0
Friday	20h	0	0	1	0	0	0	0	0
Saturday	40h	0	1	0	0	0	0	0	0

Only one bit can be set to 1 each time.

**Table9. Daily registers**

Address	Function	bit7	bit6	bit5	bit4	bit3	bit2	bit1	bit0	Default
0x14	DAY	○	○	BCD code, Day tens place, 0-3		BCD code, Day ones place, 0-9				0x01

DAY: BCD format, the value range will be adjusted automatically according to the month setting and if a leap year or not.

**Table10. DAY Register Value**

Month	Day Value Range
1, 3, 5, 7, 8, 10, 12	1~31
4, 6, 9, 11	1~30
February in normal year	1~28
February in leap year	1~29

Address	Function	bit7	bit6	bit5	bit4	bit3	bit2	bit1	bit0	Default
0x15	MONTH	○	○	○	BCD code, Month tens place, 0-1	BCD code, Month ones place, 0-9				0x01
0x16	YEAR	BCD code, Year tens place, 0-9				BCD code, Year ones place, 0-9				0x00

MONTH: BCD format, Value1~12

YEAR: BCD format, Value0~99(2000~2099)

Example: 2020/01/01 Wednesday 21:18:36

Address	Function	bit7	bit6	bit5	bit4	bit3	bit2	bit1	bit0
0x10	SEC	○	0	1	1	0	1	1	0
0x11	MIN	○	0	0	1	1	0	0	0
0x12	HOUR	○	○	1	0	0	0	0	1
0x13	WEEK	○	0	0	0	1	0	0	0
0x14	DAY	○	○	0	0	0	0	0	1
0x15	MONTH	○	○	○	0	0	0	0	1
0x16	YEAR	0	0	1	0	0	0	0	0



## 6.2.2 Alarm registers

Address	Function	bit7	bit6	bit5	bit4	bit3	bit2	bit1	bit0	Default
0x17	MIN Alarm	AE	BCD code, Minute tens place, 0-5			BCD code, Minute ones place, 0-9				0x00
0x18	HOUR Alarm	AE	●	BCD code, Hour tens place, 0-2		BCD code, Minute ones place, 0-9				0x00
0x19	WEEK Alarm	AE	6	5	4	3	2	1	0	0x00
	DAY Alarm		●	BCD code, Day tens place, 0-3		BCD code, Day ones place, 0-9				

1. Set specific day, week, hour, minute value, cooperate with AIE, AF, WADA, generate alarm interrupt;
2. WEEK Alarm/DAY Alarm: WADA bit control 0x0A is set for daily or weekly Alarm. For details, see 0x1C register bit3;
3. AE (Alarm Enable): Alarm control, 0- Enable. 1 - Disable;
4. AF function bit see 0x1D register bit3;
5. AIE function bit see register 0x1E bit3 for details;

## 6.2.3 Timer registers

Address	Function	bit7	bit6	bit5	bit4	bit3	bit2	bit1	bit0	Default
0x1A	Timer Counter 0	128	64	32	16	8	4	2	1	0x00
0x1B	Timer Counter 1	32768	16384	8192	4096	2048	1024	512	256	0x00

1. Set a specific timer value, count down to 0, cooperate with TE, TF, TIE, TSEL[2:0], generate alarm interrupt;
2. TE function bit see 0x1C register bit4;
3. TF function bit see 0x1D register bit4;
4. TIE function bit see 0x1E register bit4;
5. TSEL[2:0] function bits see 0x1C register bit2, bit1, bit0 bits;

## 6.2.4 Extension registers

Address	Function	bit7	bit6	bit5	bit4	bit3	bit2	bit1	bit0	Default
0x1C	Extension Register	FSEL [1]	FSEL [0]	USEL	TE	WADA	TSEL [2]	TSEL [1]	TSEL [0]	0x04

1. Alarm function, time update interrupt, Settings, etc. used to specify a specific target;
2. WADA (Week Alarm/Day Alarm) : 0-WEEK Alarm, 1-DAY Alarm;
3. USEL (Update Interrupt Select) : 0-interrupts per second (default), 1-interrupts per minute;
4. TE (Timer Enable) : 0- Disables the Timer interrupt function. 1- enables the Timer interrupt function

FSEL[1], FSEL[0]: FOUT frequency setting:



FSEL[1]	FSEL[0]	FOUT Frequency
0	0	32.768KHz (Default)
0	1	1024Hz
1	0	1Hz
1	1	off

When STOP is to set to 1, the output is 32768Hz and 1024Hz, but not 1Hz.

TSEL[2], TSEL[1], TSEL[0] : timer count clock selection, as shown in the following table:

TSEL[2]	TSEL[1]	TSEL[0]	Timer clock	Interrupt pulse duration
0	0	0	4096Hz (244.14us)	122uS
0	0	1	64Hz (15.625ms)	7.57mS
0	1	0	1Hz (1 second)	7.57mS
0	1	1	1/60Hz (1 minute)	7.57mS
1	0	0	1/3600Hz (1 hour)	7.57mS

### 6.2.5 Flag registers

Address	Function	bit7	bit6	bit5	bit4	bit3	bit2	bit1	bit0	Default
0x1D	Flag Register	VBLF	○	UF	TF	AF	RSF	VLF	VBFF	0x06

UF (Update Flag): Time update flag bit that changes from "0" to "1" when a time update interrupt event occurs and remains "1" until software writes "0";

TF (Timer Flag): Timer flag bit that changes from "0" to "1" when a fixed periodic interrupt occurs and remains "1" until software writes "0".

AF (Alarm Flag): Alarm flag bit that changes from "0" to "1" when an alarm interrupt occurs and remains "1" until the software writes "0".

VLF (Voltage Low Flag): Voltage low signal, when the voltage is lower than -vdet2, set "1" and keep "1" until software write "0".

VBFF (VBAT Full Charged Flag): Rechargeable battery charging flag. "0" means charging, "1" means charging completed, updated every second.

VBLF (VBAT Low Flag): Battery low voltage indicator. Set "1" when voltage is lower than VDET4 and keep "1" until software writes "0";

RSF (Reset Flag): Reset flag. Set '1' when voltage is below -vdet1 and keep "1" until software writes "0";

**Table11. RSF Settings**

RSF	Description	Note
0	Clear 0	Write operation
1	Disallow operations (write 1 is ignored)	
0	-	Read operation
1	V <sub>BAT</sub> lower than -V <sub>DET</sub> detected	



**Table12. VBLF Settings**

VBLF	Describe	Note
0	Clear 0	Write operation
1	Disallow operations (write 1 is ignored)	
0	-	Read operation
1	Voltage below V <sub>DET4</sub> detected	

### 6.2.6 Control registers

Address	Function	bit7	bit6	bit5	bit4	bit3	bit2	bit1	bit0	Default
0x1E	Control Register 0	TEST	STOP	UIE	TIE	AIE	TSTP	TBKON	TBKE	0x00
0x1F	Control Register 1	SMPTSEL [1]	SMPTSEL [0]	CHGEN	INIEN	○	RSVSEL	BFVSEL [1]	BFVSEL [0]	0x00

TEST: The manufacturer test bit must be 0 and cannot be modified by users;

UIE: Update Interrupt Enable bit. When UF changes from “0” to “1”, this bit controls if an interrupt signal is generated. 0-disable (/INT keeps Hi-Z), 1-enable (/INT status changes from Hi-Z to Low).

TIE: Timer Interrupt Enable bit: When TF changes from “0” to “1”, this bit controls if an interrupt signal is generated. 0-disable (/INT keeps Hi-Z), 1-enable (/INT status changes from Hi-Z to Low).

AIE: Alarm Interrupt Enable bit: When AF changes from “0” to “1”, this bit controls if an interrupt signal is generated. 0-disable (/INT keeps Hi-Z), 1-enable (/INT status changes from Hi-Z to Low);

TSTP (Timer Stop): This bit is used to Stop the countdown of a Timer with a fixed period. It is usually used with STOP, TE, and TBKE bits;

CHGEN (Charge Enable): Charge control switch of the standby battery. CHGEN is used for non-rechargeable batteries. The default value is 0. CHGEN position "1" for rechargeable batteries.

INIEN: Control bit of FOUT and IO, when VDD<-VDET1. INIEN=0, FOUT and IO are unavailable. INIEN=1, VDD<-VDET1, FOUT and IO are available;

**Table13. INIEN Settings**

INIEN	Describe	Note
0	1. I2C and FOUT functions are available;	
1	1. When VDD < VDET1, I2C and FOUT functions are unavailable; 2. When VDD is greater than VDET1, I2C and FOUT functions are available;	

STOP: used to STOP the timing operation. When "STOP=1", all timing updates and calendar operations STOP; Fixed period timer interrupt function partially stops; 32768Hz and 1024Hz can be output, but 1Hz output is disabled;

**Table14. Fixed-period timer stop control (TSTP setting)**

TE	STOP	TBKE	TSTP	Note
1	0	0	0	TSTP writing “0” will restart the timer





TE	STOP	TBKE	TSTP	Note
				countdown.
			1	TSTP writes “1” to stop the timer
		1	x	The TSTP value setting is invalid and the count does not stop even if set in TSTP= “1”.
	1	x	x	The timer stops when it is set to 64Hz, 1Hz, 1/60Hz or 1/3600Hz.
0	x	x	x	no counting

TBKON (Timer Backup On)、TBKE (Timer Backup Enable): which is used to select the working time of the main power supply or the backup power supply. The count value is added.

**Table15. Fixed-period timer normal mode/backup mode control**

TBKE	TBKON	Note
1	0	This setting counts it at time of VDD supply mode
	1	This setting counts it at time of VBAT supply mode
0	x	This setting counts on VDD supply mode and VBAT supply mode

SMPTSEL [1:0] (Sampling Time Select), for determining voltage detection period.

**Table16. VDET3, VDET4 intermittent detection period**

SMPTSEL [1:0]	VDD work (Battery charging)	VDD work (Battery charging completed)	VDD work (Return from backup mode, VDET1>VDD>VDET2)	Note
00	2ms	2ms	2ms	The default 00
01	16ms	16ms	2ms	
10	128ms	128ms	2ms	
11	256ms	256ms	2ms	

RSVSEL (Reset Voltage Select): Sets VDD pin Voltage detection level. VDET1 voltage level setting. If VDD drops below this level, output /RST signal and stop I/F and FOUT output depending on INIEN bit Settings;

**Table17. RSVSEL Settings**

RSVSEL	Describe	Note
0	2.6V	-V <sub>DET11</sub>
1	2.55V	-V <sub>DET12</sub>

BFVSEL [1:0]: Setting the full charge detection threshold voltage to stop charging of the backup battery.



**Table18. BFVSEL Settings**

BFVSEL [1]	BFVSEL [0]	Describe
0	0	+VDET31
0	1	+VDET32
1	0	+VDET30
1	1	Off (unlimited charging)

### 6.2.7 Digital offset register

Address	Function	bit7	bit6	bit5	bit4	bit3	bit2	bit1	bit0	Default
0x30	Digital offset	DTE	L7	L6	L5	L4	L3	L2	L1	0x00

DTE (Digital offset function Enable): Enables the digital offset adjustment function. If DET is “1”, digital offset adjustment is enabled. DET is “0” to turn off digital offset adjustment; After the digital offset function is enabled, the digital offset register adjusts the sub-second clock according to the value set in the digital offset register. The calibration of the "seconds" register takes place every 10 seconds and the amount of offset set determines the intensity of the calibration. This feature does not affect the 32.768 kHz signal output on the FOUT pin because it does not change the oscillation frequency of the built-in crystal. In the case of 1Hz or 1024Hz signal output on FOUT, the offset correction will cause some jitter on the clock signal. The alarm function and wake timer function (if a source clock less than 4096 Hz is selected) are affected by this function. The following table shows the corresponding offset value from L7 to L1. When L7 bit is “0”, the offset value is positive (the clock runs faster) and when L7 bit is “1” the offset value is negative (the clock runs slower):

**Table19. Digital offset registers**

L7	L6	L5	L4	L3	L2	L1	Offset Value (ppm)
0	1	1	1	1	1	1	+192.26
0	1	1	1	1	1	0	+189.21
...	.....						...
0	0	0	0	0	1	0	+6.1
0	0	0	0	0	0	1	+3.05
0	0	0	0	0	0	0	±0
1	1	1	1	1	1	1	-3.05
1	1	1	1	1	1	0	-6.1
...	.....						...
1	0	0	0	0	0	1	-192.26
1	0	0	0	0	0	0	-195.31

Digital offset calculation method is as follows.

When the offset value is positive,  $L [7:1] = [\text{Offset Value}] / 3.05$ , decimals are discarded.

When the offset value is negative,  $L [7:1] = 128 - [\text{Offset Value}] / 3.05$ , decimals are discarded.



## 6.2.8 Extended register 1

Address	Function	bit7	bit6	bit5	bit4	bit3	bit2	bit1	bit0	Default
0x31	Extension Register1	○	○	○	○	○	○	○	VBLFE	0x00

VBLFE (VBAT Low Flag Enable) : enables the battery Low voltage detection function;

**Table20. VBLFE Settings**

Operation	VBLFE	Describe
Write	0	CHGEN:0 VBLF detection not enable CHGEN:1 VBLF detection enable (during normal mode re-chargeable battery charging)
	1	VBLF detection enable during VDD supply

If you want to use VBLF detection, the INIEN should be set to 1 in addition to VBLFE bit setting. In VDD drive mode VBAT low voltage (non-rechargeable, rechargeable battery) can be detected. VBLF function is not available in case of backup mode.



## 7 I<sup>2</sup>C Bus Interface

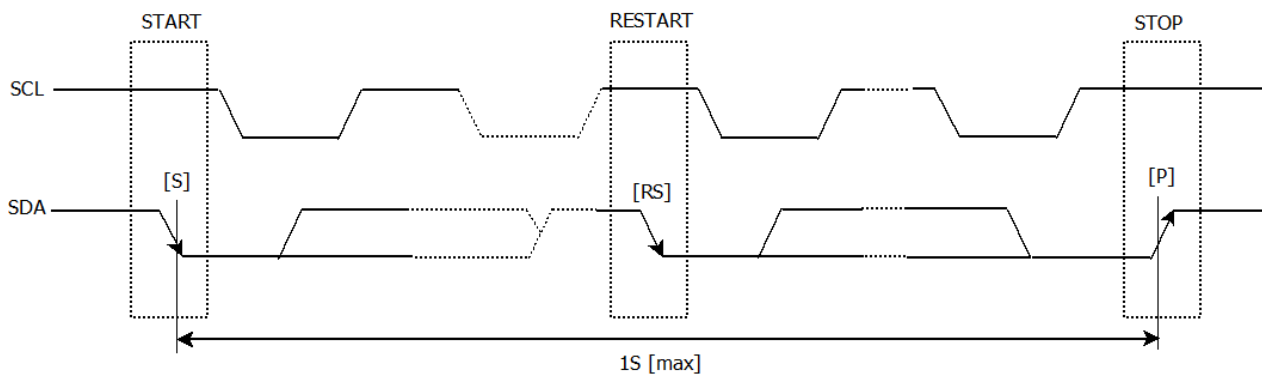

I<sup>2</sup>C bus supports bi-directional communications through a serial clock line SCL and a serial data line SDA. I<sup>2</sup>C bus device can be defined as “Master” and “Slave”. INS5T8130 can only be used as Slave.

### 7.1 Cautions

I<sup>2</sup>C bus includes START, RESTART, STOP conditions, the duration between START and STOP must be less than 1 second just in case the bus to be set to standby mode automatically. A new START condition must be transferred before restarting of any communications.

INS5T8130 I<sup>2</sup>C bus interface supports single byte read/write operations as well as multiple bytes incremental access. After 0xFF address, the next one will be 0x00.

### 7.2 Slave Address

**Table21. I<sup>2</sup>C Bus Slave Address**

Transfer data	Slave address							R/W
	bit7	bit6	bit5	bit4	bit3	bit2	bit1	bit0
65h (Read)	0	1	1	0	0	1	0	1 (Read)
64h (Write)								0 (Write)

INS5T8130 I<sup>2</sup>C bus Slave Address is [0110 010\*].

### 7.3 I<sup>2</sup>C bus protocol

It is assumed CPU is master and INS5T8130 is slave in this section.

#### 7.3.1 Write process

I<sup>2</sup>C bus includes an address auto-increment function, once the initial address has been specified, the



INS5T8130 increments (+1) the address automatically after each data is sent, then to write next data.

- (1) CPU sends start condition[S]
- (2) CPU sends INS5T8130's slave address with R/W bit to set to write mode
- (3) CPU verifies ACK signal from INS5T8130
- (4) CPU sends write address to INS5T8130
- (5) CPU verifies ACK signal from INS5T8130
- (6) CPU sends write data to the address specified at step (4)
- (7) CPU verifies ACK signal from INS5T8130
- (8) Repeat (6) (7) if multiple bytes need to be written, address will be incremented automatically
- (9) CPU ends stop condition[P]

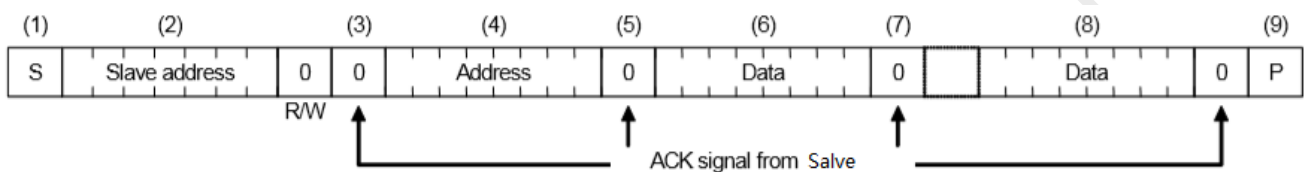

### 7.3.2 Read process

Writing the address to be read with write mode firstly, then reading the data with read mode.

- (1) CPU sends start condition[S]
- (2) CPU sends INS5T8130's slave address with R/W bit to set to write mode
- (3) CPU verifies ACK signal from INS5T8130
- (4) CPU sends address for reading from INS5T8130
- (5) CPU verifies ACK signal from INS5T8130
- (6) CPU sends RESTART condition [Sr]
- (7) CPU sends INS5T8130's slave address with R/W bit to set to read mode
- (8) CPU verifies ACK signal from INS5T8130
- (9) CPU reads data from the specified address in step (4)
- (10) CPU sends ACK signal for "0"
- (11) Repeat (9) (10) if multiple bytes need to be read, address will be incremented automatically
- (12) CPU sends ACK signal for "1"
- (13) CPU sends stop condition[P]

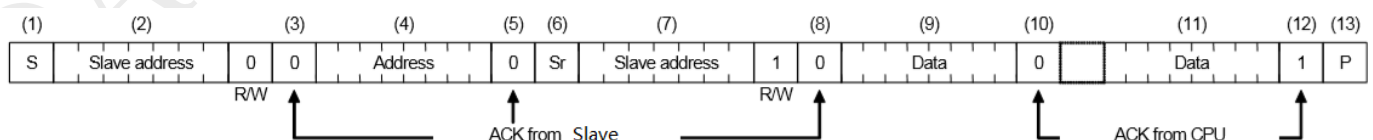



## 8 Reflow Soldering Curve

Standard: IPC/JEDEC J-STD-020

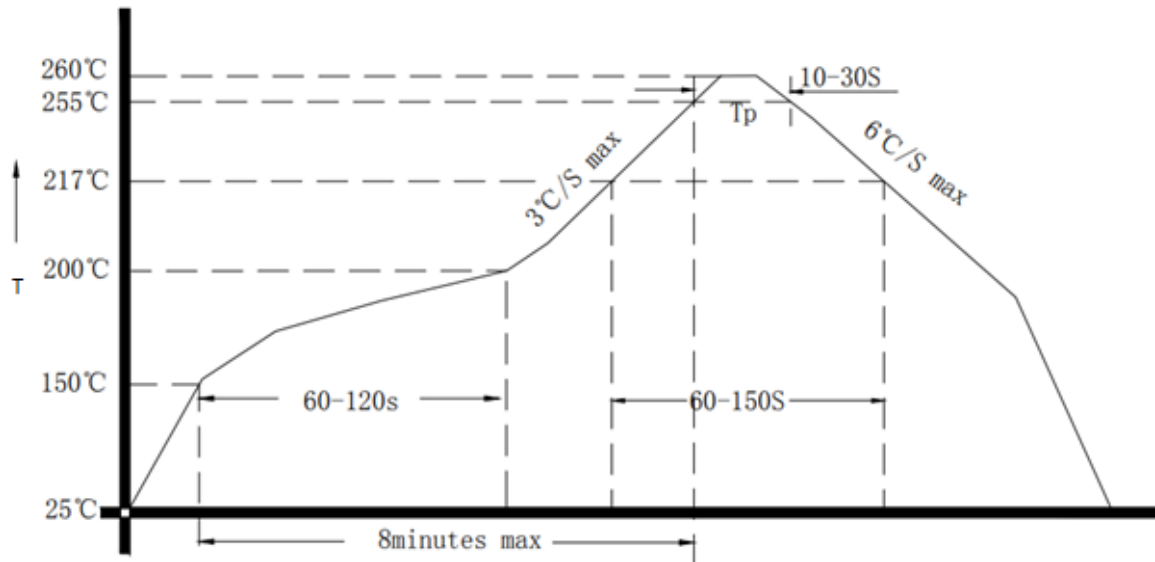

Figure 2. Reflow Soldering Curve

Note: It is suggested to solder IC under the condition shown in the curve above. Must pay attention to the temperature and time when manual soldering, if the temperature over +260°C, or you will make the xo performance bad, even damage it.



# 9 Dimensions

MPN:	INS5T8130CFX
------	--------------

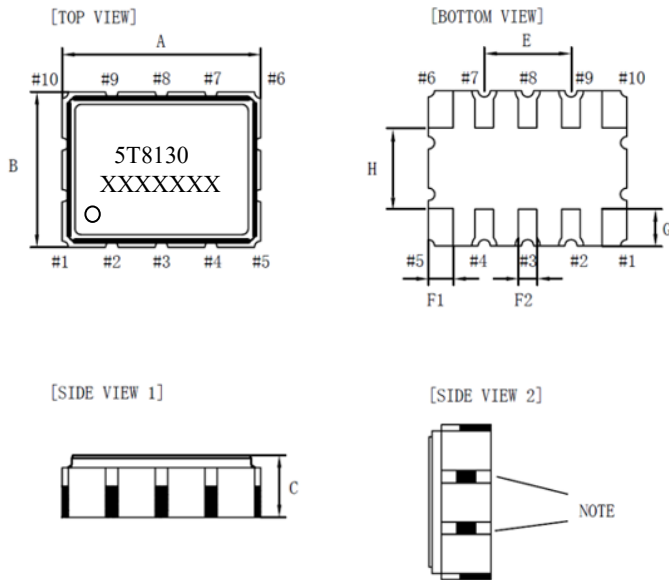

Dimension	Min.	Typ.	Max.
<b>A</b>	3.1	3.2	3.3
<b>B</b>	2.4	2.5	2.6
<b>C</b>	0.8	0.9	1.0
<b>E</b>	--	1.4	--
<b>F1</b>	--	0.4	--
<b>F2</b>	--	0.3	--
<b>G</b>	--	0.6	--
<b>H</b>	--	1.3	--

(Unit: mm)

Figure 1. Dimension

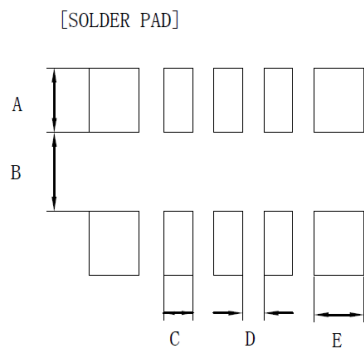

Dimension	Max.
<b>A</b>	0.9
<b>B</b>	1.1
<b>C</b>	0.4
<b>D</b>	0.3
<b>E</b>	0.7

(Unit: mm)

## Recommended Soldering Pattern



MPN:	INS5T8130SFX
------	--------------

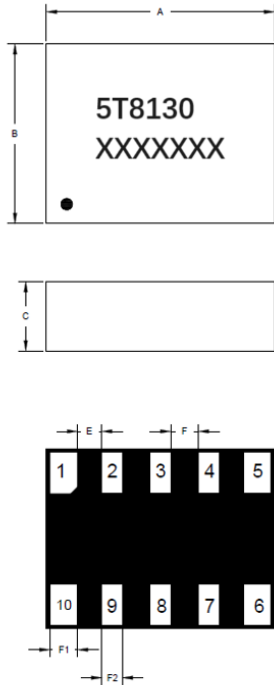

Dimension	Min.	Typ.	Max.
<b>A</b>	3.0	3.2	3.4
<b>B</b>	2.3	2.5	2.7
<b>C</b>	--	1.0	--
<b>E</b>	--	0.30	--
<b>F</b>	--	0.4	--
<b>G</b>	--	0.6	--
<b>H</b>	--	1.3	--
<b>F1</b>	--	0.45	--
<b>F2</b>	--	0.30	--

(Unit: mm)

Figure 1. Dimension

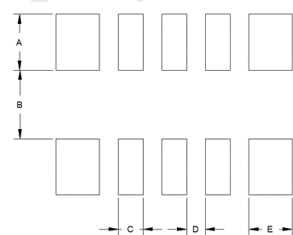

Dimension	Max.
<b>A</b>	0.9
<b>B</b>	1.1
<b>C</b>	0.4
<b>D</b>	0.3
<b>E</b>	0.7

(Unit: mm)

Figure 2. Recommended Soldering Pattern





# 10 Package

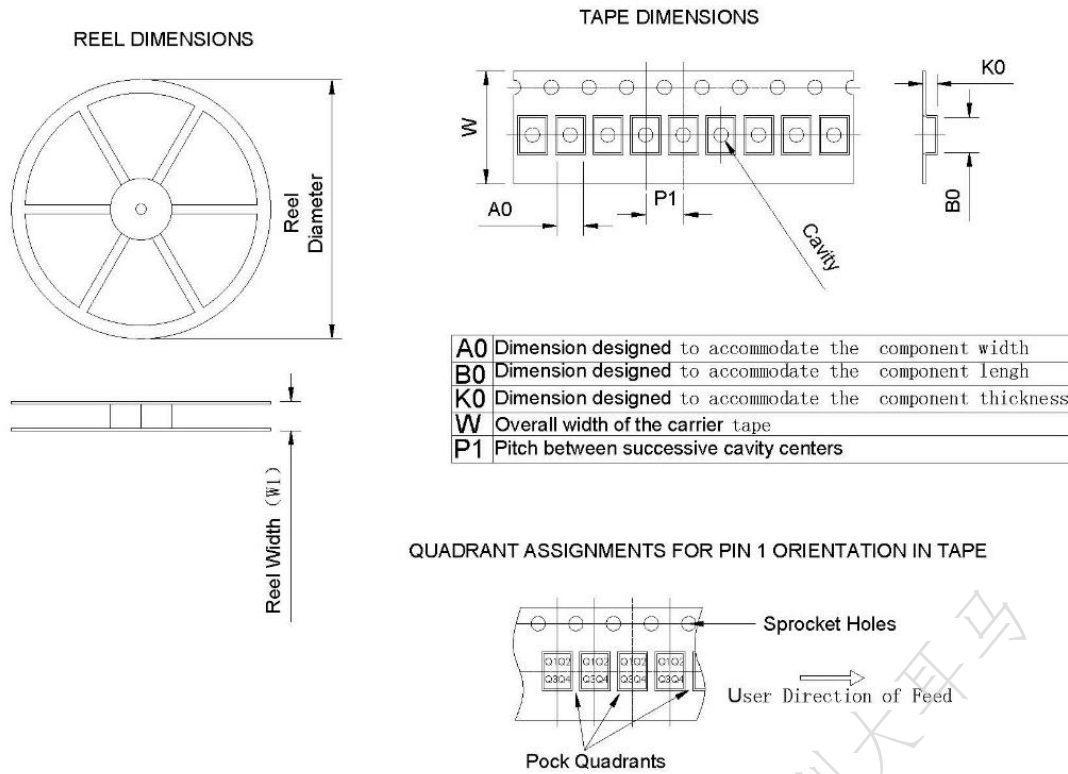

Device	Package Type	Pins	SPQ	Reel Diameter (mm)	Reel Width W1(mm)	A0 (mm)	B0 (mm)	K0 (mm)	P1 (mm)	W (mm)	PIN1 Quadrant
INS5T8130CFX	Ceramic	10	3000	180	11.6±2.0	3.00	3.70	1.50	4.00	8.00	Q1
INS5T8130SFX	LGA	10	3000	180	11.6±2.0	3.00	3.70	1.50	4.00	8.00	Q1

Figure 3. Package



## 11 Revision History

Version	Change Contents	Prepared by	Revised Date
V1.0	First Issued		2023.09.20
V1.1	<ol style="list-style-type: none"> <li>1. Key Features: Add environment description of “Rosh2.0, REACH &amp; Halogen-free compliant”</li> <li>2. Chapter 7” Package”: Update Device name from “INS5T8130” to “INS5T8130CFX” in the table.</li> </ol>		2024.05.14
V1.2	<ol style="list-style-type: none"> <li>1. Simplify original MPN</li> <li>2. Add new MPN “INS5T8130SFX”</li> <li>3. Chapter 6, add new Dimensions of “INS5T8130SFX”</li> <li>4. Chapter 7 “Package”: Correct an error, change package type from “LGA” to “Ceramic”</li> <li>5. Chapter 7, add new package information for “INS5T8130SFX”</li> </ol>		2024.06.06