

To Customer: _____

Realtime Clock Module

INS5T8900

Datasheet

Document Version 1.0

Released on May 24th, 2024

Ordering Information

| Manufacture Part Number | Product Name | Description |
|-------------------------|--------------|--|
| INS5T8900-3BEY000Y00CA | INS5T8900 | ± 5ppm@-40°C~+85°C, 0.55uA(Typ), Ceramics 3225 |
| INS5T8900-3BEY000Y00SA | INS5T8900 | ± 5ppm@-40°C~+85°C, 0.55uA(Typ), LGA 3225 |
| INS5T8900-3BEX000Y00CA | INS5T8900 | ± 3ppm@-40°C~+85°C, 0.55uA(Typ), Ceramics 3225 |
| INS5T8900-3BEX000Y00SA | INS5T8900 | ± 3ppm@-40°C~+85°C, 0.55uA(Typ), LGA 3225 |
| INS5T8900-3BZY000Y00CA | INS5T8900 | ± 5ppm@-40°C~+85°C ± 8ppm @85°C~105°C, 0.55uA(Typ), Ceramics 3225 |
| INS5T8900-3BZY000Y00SA | INS5T8900 | ± 5ppm@-40°C~+85°C ± 8ppm @85°C~105°C, 0.55uA(Typ), LGA 3225 |
| | | |
| | | |

Guangdong Dapu Telecom Technology Co., Ltd

Bldg 5, SSL Modern Enterprise Accelerator Zone, Dongguan City, Guangdong Province, PRC China

TEL:0086-0769-88010888

FAX:0086-0769-81800098

Index

| | | |
|----------|---|-----------|
| 1 | OVERVIEW | 4 |
| 2 | KEY FEATURES | 4 |
| 3 | BLOCK DIAGRAM | 4 |
| 4 | PIN DEFINITION | 5 |
| 5 | ELECTRICAL CHARACTERISTICS | 6 |
| 5.1 | ABSOLUTE MAXIMUM RATINGS | 6 |
| 5.2 | RECOMMENDED OPERATING CONDITIONS..... | 6 |
| 5.3 | FREQUENCY CHARACTERISTICS | 6 |
| 5.4 | DC CHARACTERISTICS | 7 |
| 5.5 | AC CHARACTERISTICS..... | 9 |
| 6 | REGISTERS | 10 |
| 6.1 | REGISTER LISTS | 10 |
| 6.2 | DETAILS OF REGISTERS..... | 11 |
| 6.2.1 | <i>Clock counter registers</i> | 11 |
| 6.2.2 | <i>Alarm registers</i> | 13 |
| 6.2.3 | <i>Timer control registers</i> | 13 |
| 6.2.4 | <i>Extension registers</i> | 14 |
| 6.2.5 | <i>Flag registers</i> | 14 |
| 6.2.6 | <i>Control registers</i> | 15 |
| 6.2.7 | <i>Temperature register</i> | 15 |
| 6.2.8 | <i>Battery Backup switchover register</i> | 15 |
| 6.2.9 | <i>Device ID register</i> | 16 |
| 6.2.10 | <i>Sub-second timer register</i> | 16 |
| 7 | I²C BUS INTERFACE | 17 |
| 7.1 | CAUTIONS..... | 17 |
| 7.2 | SLAVE ADDRESS | 17 |
| 7.3 | I ² C BUS PROTOCOL | 17 |
| 7.3.1 | <i>Write process</i> | 17 |

| | | |
|-------|-----------------------------|----|
| 7.3.2 | Read process..... | 18 |
| 8 | REFLOW SOLDERING CURVE..... | 19 |
| 9 | DIMENSIONS..... | 20 |
| 10 | PACKAGE..... | 22 |
| 11 | REVISION HISTORY..... | 24 |

DAPU Confidential
FOR dptel

1 Overview

INS5T8900 is a high-accuracy I²C bus interface real-time clock with low power consumption. It embeds a 32.768KHz TCXO. The high precise temperature sensor and temperature compensated circuit ensure the high clock accuracy. It supports calendar (year, month, day, hour, minute, second), clock and timer functions etc.

2 Key Features

- Low current consumption: 550nA (Typ.)
- High stability:
±5ppm @ -40°C~85°C; ±3ppm @ -40°C~85°C;
±8ppm @ 85°C~105°C;
- Build-in TCXO: 32.768KHz
- Build-in temperature sensor
- Communication Interface: I²C bus
- Power Supply Voltage: 1.6V~5.5V
- Operation Temperature Range: -40°C ~ +85°C
- Leap years autocorrection
- Backup battery switchover function
- Timer output function with adjustable period
- Size:3.2mm × 2.5mm × 0.9mm
- RoHS2.0, REACH & Halogen-free compliant

3 Block Diagram

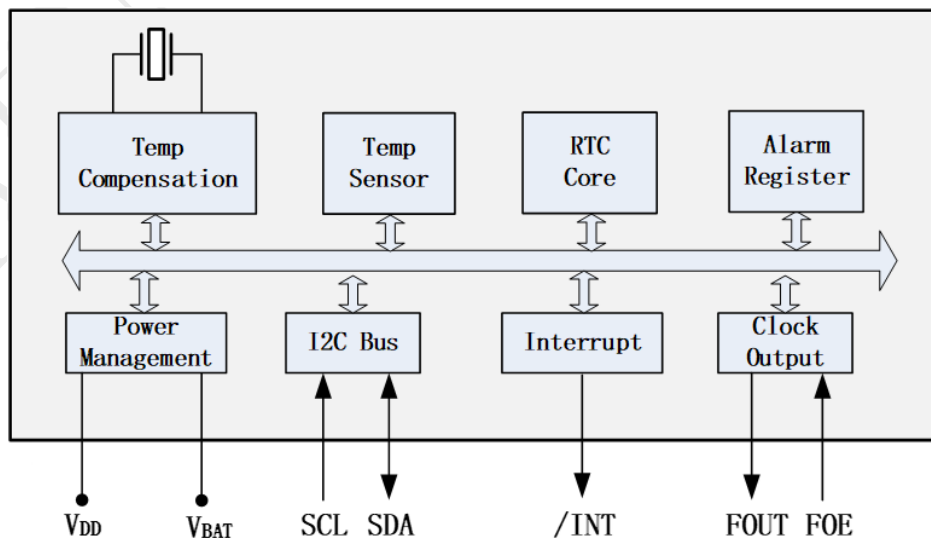

Figure1. Block Diagram

4 Pin definition

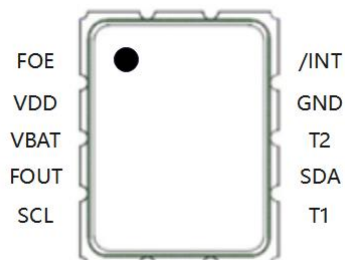

Table1. Pin Definition

| Pin Number | Pin Name | I/O | Description |
|------------|------------------|--------|--|
| 1 | FOE | In | FOUT output control pin. "1" - enable FOUT, "0"- FOUT Hi-Z |
| 2 | V _{DD} | - | Power supply |
| 3 | V _{BAT} | - | Backup battery pin. Connect to large-capacity capacitors or a backup battery. Connect to V _{DD} when switchover function is not necessary |
| 4 | FOUT | Out | Frequency output. Controlled by FOE. Frequency can be set by FSEL bits. |
| 5 | SCL | In | I ² C clock signal |
| 6 | T1 | - | Manufacturer test only. Ensure to be floating |
| 7 | SDA | In/Out | I ² C data signal |
| 8 | T2 | - | Manufacturer test only. Ensure to be floating |
| 9 | GND | - | Ground |
| 10 | /INT | Out | Interrupt Output, Open-Drain |

5 Electrical Characteristics

5.1 Absolute Maximum Ratings

Table2. Absolute Maximum Ratings

| Parameter | Symbol | Value | | | Unit | Notes |
|------------------------|-------------------|---------|------|----------------------|------|---------------|
| | | Min. | Typ. | Max. | | |
| Power Supply Voltage | V _{DD} | -0.3 | | 6.5 | V | |
| Backup Battery Voltage | V _{BAT} | -0.3 | | 6.5 | V | |
| Input Voltage | V _{IN} | GND-0.3 | | 6.5 | V | FOE, SCL, SDA |
| Clock Output Voltage | V _{OUT1} | GND-0.3 | | V _{DD} +0.3 | V | FOUT |
| Output Voltage | V _{OUT2} | GND-0.3 | | 6.5 | V | SDA, /INT |
| Storage temperature | T _{STG} | -55 | | 125 | °C | |

5.2 Recommended Operating Conditions

Table3. Recommended Operating Conditions

| Parameter | Symbol | Value | | | Unit | Notes |
|---------------------------------------|------------------|-------|------|------|------|----------------------------------|
| | | Min. | Typ. | Max. | | |
| Power Supply Voltage (Power on) | V _{DD} | 2.5 | 3.0 | 5.5 | V | * |
| Power Supply Voltage (Normal mode) | V _{DD} | 1.6 | 3.0 | 5.5 | V | |
| Power Supply Voltage (Backup mode) | V _{BAT} | 1.6 | 3.0 | 5.5 | V | |
| Current consumption | I _{DD} | | 0.55 | | uA | Using Battery supply only, @25°C |
| Operation temperature | T _{OPR} | -40 | 25 | 105 | °C | |

*Note:

1. During the power on and oscillation starting time, a voltage of more than 2.5V must be provided to ensure the oscillation circuit to a stable state.
2. After the power supply is removed or power off, ensure that VDD=GND for more than 10 seconds before next power on cycle.
3. If there is no special indication, the test conditions are GND =0V, VDD=1.6V~5.5V, Ta=-40°C~+105°C

5.3 Frequency Characteristics

Table4. Frequency Characteristics

| Parameter | Symbol | Value | | | Unit | Notes |
|---------------------|------------------|--|------|------|------|------------------------------|
| | | Min. | Typ. | Max. | | |
| Frequency stability | $\Delta f/f$ | $\pm 3\text{ppm @ } -40^\circ\text{C} \sim +85^\circ\text{C}$ | | | | 3BEX000Y00CA 3BEX000Y00SA |
| | | $\pm 5\text{ppm @ } -40^\circ\text{C} \sim +85^\circ\text{C}$ | | | | 3BEY000Y00CA 3BEY000Y00SA |
| | | $\pm 5\text{ppm @ } -40^\circ\text{C} \sim +85^\circ\text{C}$ $\pm 8\text{ppm @ } 85^\circ\text{C} \sim +105^\circ\text{C}$ | | | | 3BZY000Y00CA 3BZY000Y00SA |
| Oscillation start | t _{STA} | | | 1 | s | @25°C, VDD=3V |

| Parameter | Symbol | Value | | | Unit | Notes |
|-----------------------------|-----------|-------|------|------|------|-------------------|
| | | Min. | Typ. | Max. | | |
| time | | | | | | |
| Year Aging | f_a | -5 | | +5 | ppm | @25°C, First year |
| Temperature Sensor Accuracy | T_{emp} | -5 | | +5 | °C | $V_{DD}=3.0V$ |
| FOUT duty cycle | t_w/t | 40 | 50 | 60 | % | |

Note:

 If there is no special indication, the test conditions are $GND = 0V$, $V_{DD} = V_{BAT} = 1.6V \sim 5.5V$, $T_a = -40^{\circ}C \sim +105^{\circ}C$

5.4 DC Characteristics

Table5. DC Characteristics

| Parameter | Symbol | Value | | | Unit | Notes | | |
|------------------------------|-----------|----------------|------|----------------|------|---|--|-------------------------------------|
| | | Min. | Typ. | Max (105°C) | | | | |
| Average Current consumption1 | I_{DD1} | | 0.6 | 15 | uA | $V_{DD}=5.0V$ $T_a=105^{\circ}C$ | $f_{SCL}=0Hz$, $FOE=GND$, $/INT = V_{DD}$; $V_{DD}=V_{BAT}$; FOUT off (High-Z); Compensation interval 2s; VDD voltage detection time 2ms | |
| Average Current consumption2 | I_{DD2} | | 0.55 | 12 | | | | $V_{DD}=3.0V$ $T_a=105^{\circ}C$ |
| Average Current consumption3 | I_{DD3} | | 3 | 18 | uA | $V_{DD}=5.0V$ $T_a=105^{\circ}C$ | $f_{SCL}=0Hz$, $FOE=V_{DD}$, $/INT = V_{DD}$; $V_{DD}=V_{BAT}$; FOUT:32.768kHz, $CL=0pF$; Compensation interval 2s; V_{DD} voltage detection time 2ms | |
| Average Current consumption4 | I_{DD4} | | 1.5 | 15 | | | | $V_{DD}=3.0V$ $T_a=105^{\circ}C$ |
| Voltage Low Detection | V_{low} | 0.8 | 1.1 | 1.4 | V | | | |
| VDD Voltage Detection | V_{det} | 1.8 | 2.1 | 2.4 | V | | | |
| High-level input voltage | V_{IH} | $0.8 * V_{DD}$ | | 5.5 | V | SCL, SDA, FOE pin | | |
| Low-level input voltage | V_{IL} | GND-0.3 | | $0.2 * V_{DD}$ | V | | | |
| High-level output voltage | V_{OH1} | 4.0 | | 5.0 | V | $V_{DD}=5.0V$, $I_{OH} = -1mA$ | FOUT pin | |
| | V_{OH2} | 2.2 | | 3.0 | | | | $V_{DD}=3.0V$, $I_{OH} = -1mA$ |
| | V_{OH3} | 2.9 | | 3.0 | | | | $V_{DD}=3.0V$, $I_{OH} = -100uA$ |
| Low-level output voltage | V_{OL1} | GND | | GND+0.5 | V | $V_{DD}=5.0V$, $I_{OL} = 1mA$ | FOUT pin | |
| | V_{OL2} | GND | | GND+0.8 | | | | $V_{DD}=3.0V$, $I_{OL} = 1mA$ |
| | V_{OL3} | GND | | GND+0.1 | | | | $V_{DD}=3.0V$, $I_{OL} = 100uA$ |
| | V_{OL4} | GND | | GND+0.25 | V | $V_{DD}=5.0V$, $I_{OL} = 1mA$ | /INT pin | |
| | V_{OL5} | GND | | GND+0.4 | | | | $V_{DD}=3.0V$, $I_{OL} = 1mA$ |
| | V_{OL6} | GND | | GND+0.4 | | | | $V_{DD} \geq 3.0V$, $I_{OL} = 3mA$ |
| Input leakage current | I_{LK} | -0.5 | | 0.5 | uA | FOE, SDA, SCL pin, $V_{IN} = V_{DD}$ or GND | | |

| Parameter | Symbol | Value | | | Unit | Notes |
|------------------------|-----------------|-------|------|-------------|------|---|
| | | Min. | Typ. | Max (105°C) | | |
| Output leakage current | I _{oz} | -0.5 | | 0.5 | uA | FOUT, SDA, /INT pin, V _{IN} = V _{DD} or GND |

Note: If there is no special indication, the test conditions are GND=0V, VDD=1.6V~5.5V, Ta=-40°C~+105°C.

FOR dptel

5.5 AC Characteristics

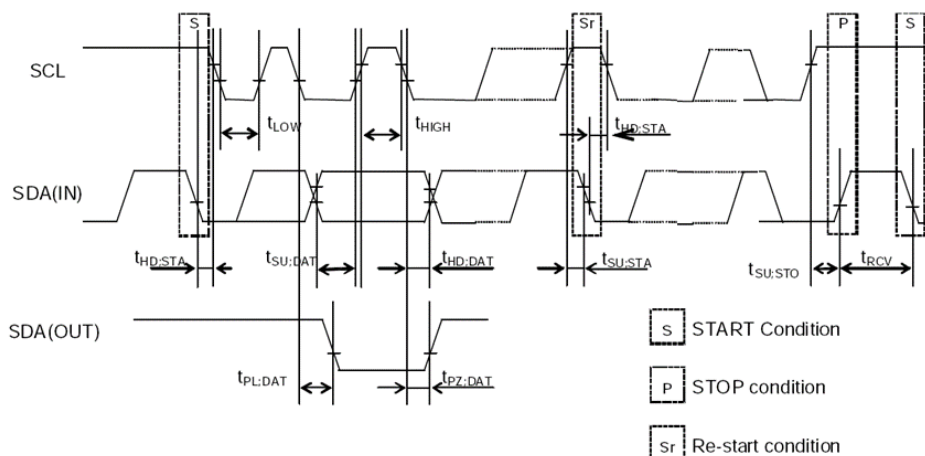

Figure2. I2C bus Timing Chart

Table6. AC Characteristics

$V_{DD}=2.5V \sim 5.5V$; $T_a=-40^{\circ}C \sim +105^{\circ}C$

| Parameter | Symbol | Value | | | Unit |
|--|--------------|-------|------|------|------|
| | | Min. | Typ. | Max. | |
| SCL clock frequency | f_{SCL} | | | 400 | kHz |
| SCL low level time | t_{LOW} | 1.3 | | | us |
| SCL high level time | t_{HIGH} | 0.6 | | | us |
| Start condition setup time | $t_{HD:STA}$ | 0.6 | | | us |
| Start condition hold time | $t_{SU:STA}$ | 0.6 | | | us |
| Stop condition setup time | $t_{SU:STO}$ | 0.6 | | | us |
| Bus idle time between start condition and stop condition | t_{RCV} | 1.3 | | | us |
| Data setup time | $t_{SU:DAT}$ | 100 | | | ns |
| Data hold time | $t_{HD:DAT}$ | 0 | | | ns |
| SCL, SDA rising time | t_r | | | 0.3 | us |
| SCL, SDA falling time | t_f | | | 0.3 | us |

Note: when the master accesses the equipment through I2C bus, all communication from sending start condition to sending stop shall be completed within 1 second. If it exceeds 1 second, the I2C bus interface will be reset through the internal bus timeout function.

6 Registers

6.1 Register Lists

Table7. Basic Time and Calendar Registers

| Address | Function | bit7 | bit6 | bit5 | bit4 | bit3 | bit2 | bit1 | bit0 | R/W |
|--------------|--------------------|--------------------------------|----------------------------------|--------------------------------|---------------------------------|----------------------------------|----------|----------|----------|-----|
| 0x00 0x10 | SEC | ○ | BCD code, Second tens place, 0-5 | | | BCD code, Second ones place, 0-9 | | | | R/W |
| 0x01 0x11 | MIN | ○ | BCD code, Minute tens place, 0-5 | | | BCD code, Minute ones place, 0-9 | | | | R/W |
| 0x02 0x12 | HOUR | ○ | ○ | BCD code, Hour tens place, 0-2 | | BCD code, Hour ones place, 0-9 | | | | R/W |
| 0x03 0x13 | WEEK | ○ | 6 | 5 | 4 | 3 | 2 | 1 | 0 | R/W |
| 0x04 0x14 | DAY | ○ | ○ | BCD code, Day tens place, 0-3 | | BCD code, Day ones place, 0-9 | | | | R/W |
| 0x05 0x15 | MONTH | ○ | ○ | ○ | BCD code, Month tens place, 0-1 | BCD code, Month ones place, 0-9 | | | | R/W |
| 0x06 0x16 | YEAR | BCD code, Year tens place, 0-9 | | | | BCD code, Year ones place, 0-9 | | | | R/W |
| 0x07 | RAM | ● | ● | ● | ● | ● | ● | ● | ● | R/W |
| 0x08 | MIN Alarm | AE | BCD code, Minute tens place, 0-5 | | | BCD code, Minute ones place, 0-9 | | | | R/W |
| 0x09 | HOUR Alarm | AE | ● | BCD code, Hour tens place, 0-2 | | BCD code, Hour ones place, 0-9 | | | | R/W |
| 0x0A | WEEK Alarm | AE | 6 | 5 | 4 | 3 | 2 | 1 | 0 | R/W |
| | DAY Alarm | | ● | BCD code, Day tens place, 0-3 | | BCD code, Day ones place, 0-9 | | | | R/W |
| 0x0B 0x1B | Timer Counter 0 | 128 | 64 | 32 | 16 | 8 | 4 | 2 | 1 | R/W |
| 0x0C 0x1C | Timer Counter 1 | ● | ● | ● | ● | 2048 | 1024 | 512 | 256 | R/W |
| 0x0D 0x1D | Extension Register | TEST | WADA | USEL | TE | FSEL [1] | FSEL [0] | TSEL [1] | TSEL [0] | R/W |
| 0x0E 0x1E | Flag Register | ○ | ○ | UF | TF | AF | ○ | VLF | VDET | R/W |
| 0x0F 0x1F | Control Register | CSEL [1] | CSEL [0] | UIE | TIE | AIE | ○ | ○ | RESET | R/W |

Table8. Extended Register Group 1

| Address | Function | bit7 | bit6 | bit5 | bit4 | bit3 | bit2 | bit1 | bit0 | R/W |
|---------|----------|------|------|------|------|------|------|------|------|-----|
| 0x17 | TEMP | 128 | 64 | 32 | 16 | 8 | 4 | 2 | 1 | R |

| Address | Function | bit7 | bit6 | bit5 | bit4 | bit3 | bit2 | bit1 | bit0 | R/W |
|---------|-----------------|------|------|------|------|----------|-------|-----------|-----------|-----|
| 0x18 | Backup Function | ○ | ○ | ○ | ○ | VDET OFF | SWOFF | BKSMP [1] | BKSMP [0] | R/W |

Table9. Extended Register Group2

| Address | Function | bit7 | bit6 | bit5 | bit4 | bit3 | bit2 | bit1 | bit0 | R/W |
|---------|--------------------|----------------|------|------|------|-------------|------|------|---------|-----|
| 0x20 | Device ID | Vendor ID[3:0] | | | | Ver[3:0] | | | | R |
| 0x21 | Control Register 1 | Reserved | | | | | | | VBAT_SW | R/W |
| 0x27 | SubSEC | Reserved | | | | SubSEC[3:0] | | | | R |

Note:

1, After power-up reset or in case VLF bit returns “1”, make sure to initialize all registers to default state before using the RTC. Ensure all inputs are in the required range and the defined values are set for the reserved bits in case the clock cannot work normally.

- ✓ During the initial power-up, below bits will be in the state as below:
 Initial 0: TEST, WADA, USEL, TE, FSEL[1:0], TSEL[0], UF, TF, AF, CSEL[1], UIE, TIE, RESET, VDETOFF, SWOFF, BKSMP[1:0], VBAT_SW.
 Initial 1: VLF, VDET, CSEL[0].
- ✓ All other register values are undefined, so make sure to reset the module before using it.
- ✓ The bits marked with “○” can be read out “0” only after initializing.
- ✓ The bits marked with “●” are RAM bits which can be used to write or read any data.
- ✓ Only 0 can be written to UF, TF, AF, VLF, VDET bits.
- ✓ Make sure “0” to be written for TEST bits which are used for testing only.
- ✓ Reserved bits are forbidden to write.

6.2 Details of Registers

6.2.1 Clock counter registers

| Address | Function | bit7 | bit6 | bit5 | bit4 | bit3 | bit2 | bit1 | bit0 | Default |
|--------------|----------|------|----------------------------------|--------------------------------|------|----------------------------------|------|------|------|---------|
| 0x00 0x10 | SEC | ○ | BCD code, Second tens place, 0-5 | | | BCD code, Second ones place, 0-9 | | | | 0x00 |
| 0x01 0x11 | MIN | ○ | BCD code, Minute tens place, 0-5 | | | BCD code, Minute ones place, 0-9 | | | | 0x00 |
| 0x02 0x12 | HOUR | ○ | ○ | BCD code, Hour tens place, 0-2 | | BCD code, Hour ones place, 0-9 | | | | 0x00 |

SEC: BCD format, Value: 0~59

MIN: BCD format, Value: 0~59

HOUR: BCD format, Value: 0~23

| Address | Function | bit7 | bit6 | bit5 | bit4 | bit3 | bit2 | bit1 | bit0 | Default |
|--------------|----------|------|------|------|------|------|------|------|------|---------|
| 0x03 0x13 | WEEK | ○ | 6 | 5 | 4 | 3 | 2 | 1 | 0 | 0x40 |

WEEK: Value 01h, 02h, 04h, 08h, 10h, 20h, 40h. Only one bit can be set to 1 each time, all others must be set to 0.

Table10. WEEK Register

| WEEK | Data | bit7 | bit6 | bit5 | bit4 | bit3 | bit2 | bit1 | bit0 |
|-----------|------|------|------|------|------|------|------|------|------|
| Sunday | 01h | 0 | 0 | 0 | 0 | 0 | 0 | 0 | 1 |
| Monday | 02h | 0 | 0 | 0 | 0 | 0 | 0 | 1 | 0 |
| Tuesday | 04h | 0 | 0 | 0 | 0 | 0 | 1 | 0 | 0 |
| Wednesday | 08h | 0 | 0 | 0 | 0 | 1 | 0 | 0 | 0 |
| Thursday | 10h | 0 | 0 | 0 | 1 | 0 | 0 | 0 | 0 |
| Friday | 20h | 0 | 0 | 1 | 0 | 0 | 0 | 0 | 0 |
| Saturday | 40h | 0 | 1 | 0 | 0 | 0 | 0 | 0 | 0 |

| Address | Function | bit7 | bit6 | bit5 | bit4 | bit3 | bit2 | bit1 | bit0 | Default |
|--------------|----------|------|------|-------------------------------|------|-------------------------------|------|------|------|---------|
| 0x04 0x14 | DAY | ○ | ○ | BCD code, Day tens place, 0-3 | | BCD code, Day ones place, 0-9 | | | | 0x01 |

DAY: BCD format, the value range will be adjusted automatically according to the month setting and if a leap year or not .

Table11. DAY Register Value

| Month | Day Value Range |
|-------------------------|-----------------|
| 1, 3, 5, 7, 8, 10, 12 | 1~31 |
| 4, 6, 9, 11 | 1~30 |
| February in normal year | 1~28 |
| February in leap year | 1~29 |

| Address | Function | bit7 | bit6 | bit5 | bit4 | bit3 | bit2 | bit1 | bit0 | Default |
|--------------|----------|--------------------------------|------|------|---------------------------------|---------------------------------|------|------|------|---------|
| 0x05 0x15 | MONTH | ○ | ○ | ○ | BCD code, Month tens place, 0-1 | BCD code, Month ones place, 0-9 | | | | 0x01 |
| 0x06 0x16 | YEAR | BCD code, Year tens place, 0-9 | | | | BCD code, Year ones place, 0-9 | | | | 0x00 |

MONTH: BCD format, Value1~12

YEAR: BCD format, Value0~99(2000~2099)

Example: 2020/01/01 Wednesday 21:18:36

| Address | Function | bit7 | bit6 | bit5 | bit4 | bit3 | bit2 | bit1 | bit0 |
|--------------|----------|------|------|------|------|------|------|------|------|
| 0x00 0x10 | SEC | ○ | 0 | 1 | 1 | 0 | 1 | 1 | 0 |
| 0x01 0x11 | MIN | ○ | 0 | 0 | 1 | 1 | 0 | 0 | 0 |
| 0x02 0x12 | HOUR | ○ | ○ | 1 | 0 | 0 | 0 | 0 | 1 |

| Address | Function | bit7 | bit6 | bit5 | bit4 | bit3 | bit2 | bit1 | bit0 |
|--------------|----------|------|------|------|------|------|------|------|------|
| 0x03 0x13 | WEEK | ○ | 0 | 0 | 0 | 1 | 0 | 0 | 0 |
| 0x04 0x14 | DAY | ○ | ○ | 0 | 0 | 0 | 0 | 0 | 1 |
| 0x05 0x15 | MONTH | ○ | ○ | ○ | 0 | 0 | 0 | 0 | 1 |
| 0x06 0x16 | YEAR | 0 | 0 | 1 | 0 | 0 | 0 | 0 | 0 |

6.2.2 Alarm registers

| Address | Function | bit7 | bit6 | bit5 | bit4 | bit3 | bit2 | bit1 | bit0 | Default |
|--------------|------------------|-----------|----------------------------------|--------------------------------|------|----------------------------------|------|------|-------|---------|
| 0x08 | MIN Alarm | AE | BCD code, Minute tens place, 0-5 | | | BCD code, Minute ones place, 0-9 | | | | 0x00 |
| 0x09 | HOUR Alarm | AE | ● | BCD code, Hour tens place, 0-2 | | BCD code, Minute ones place, 0-9 | | | | 0x00 |
| 0x0A | WEEK Alarm | AE | 6 | 5 | 4 | 3 | 2 | 1 | 0 | 0x00 |
| | DAY Alarm | | ● | BCD code, Day tens place, 0-3 | | BCD code, Day ones place, 0-9 | | | | |
| 0x0E 0x1E | Flag Register | ○ | ○ | UF | TF | AF | ○ | VLF | VDET | 0x03 |
| 0x0F 0x1F | Control Register | CSEL [1] | CSEL [0] | UIE | TIE | AIE | ○ | ○ | RESET | 0x40 |

According to AIE, AF, WADA bits setting, the alarm interrupt will be generated once the current time match the settings in the above registers, the /INT pin goes to low level and AF bit is set to '1' to record an alarm interrupt event has occurred.

WEEK Alarm/DAY Alarm: Controlled by WADA bit in 0x0D register.

AE: Alarm Enable bit, 0-enable; 1-disable.

AF: Defined in 0x0E register bit3.

AIE: Defined in 0x0F register bit3.

6.2.3 Timer control registers

| Address | Function | bit7 | bit6 | bit5 | bit4 | bit3 | bit2 | bit1 | bit0 | Default |
|--------------|------------------------|------|------|----------|------------|-----------|------|-----------|-------|---------|
| 0x0B 0x1B | Timer Counter 0 | 128 | 64 | 32 | 16 | 8 | 4 | 2 | 1 | 0x00 |
| 0x0C 0x1C | Timer Counter 1 | ● | ● | ● | ● | 2048 | 1024 | 512 | 256 | 0x00 |
| 0x0D 0x1D | Extension Register | TEST | WADA | USEL | TE | FSEL[1:0] | | TSEL[1:0] | | 0x02 |
| 0x0E 0x1E | Flag Register | ○ | ○ | Reserved | TF | Reserved | ○ | Reserved | | 0x03 |
| 0x0F | Control Register | CSEL | CSEL | UIE | TIE | AIE | ○ | ○ | RESET | 0x40 |

| Address | Function | bit7 | bit6 | bit5 | bit4 | bit3 | bit2 | bit1 | bit0 | Default |
|---------|----------|------|------|------|------|------|------|------|------|---------|
| 0x1F | | [1] | [0] | | | | | | | |

According to TE, TF, TIE, TSEL[1:0] bits setting, a timer interrupt will be generated once the value counts down to 0 from the one set in the above registers.

TE: Defined in 0x0D register bit4

TF: Defined in 0x0E register bit4.

TIE: Defined in 0x0F register bit4.

TSEL[1:0]: Defined in 0x0D register bit1 and bit0

Timer Counter: Preset values of timer counter.

6.2.4 Extension registers

| Address | Function | bit7 | bit6 | bit5 | bit4 | bit3 | bit2 | bit1 | bit0 | Default |
|---------|--------------------|------|------|------|------|---------|---------|---------|---------|---------|
| 0x0D | Extension Register | TEST | WADA | USEL | TE | FSEL[1] | FSEL[0] | TSEL[1] | TSEL[0] | 0x02 |
| 0x1D | | | | | | | | | | |

TEST: Test bit, must be set to “0”

WADA: Week Alarm/Day Alarm control bit, decide 0x0A register as DAY Alarm or WEEK Alarm. 0-WEEK alarm, 1-DAY alarm

USEL: Update Interrupt Select bit, 0-output interrupt once a second, 1-output interrupt once a minute

TE: Timer Enable bit, 0-disable, 1-enable

FSEL[1], FSEL[0]: FOUT frequency setting:

| FSEL[1] | FSEL[0] | FOUT Frequency |
|---------|---------|---------------------|
| 0 | 0 | 32.768KHz (Default) |
| 0 | 1 | 1024Hz |
| 1 | 0 | 1Hz |
| 1 | 1 | 32.768KHz |

TSEL[1], TSEL[0]: Timer countdown period(source clock) setting:

| TSEL[1] | TSEL[0] | Source clock |
|---------|---------|--------------|
| 0 | 0 | 4096Hz |
| 0 | 1 | 64Hz |
| 1 | 0 | 1Hz |
| 1 | 1 | 1/60Hz |

6.2.5 Flag registers

| Address | Function | bit7 | bit6 | bit5 | bit4 | bit3 | bit2 | bit1 | bit0 | Default |
|--------------|---------------|------|------|------|------|------|------|------|------|---------|
| 0x0E 0x1E | Flag Register | ○ | ○ | UF | TF | AF | ○ | VLF | VDET | 0x03 |

UF: Update flag bit. When time update interrupt event occurs, it will be set to “1” and keeps “1” until a “0” is written to it.

TF: Timer Flag bit. When a fixed-cycle timer interrupt event occurs, it will be set to “1” and keeps “1” until a “0” is written to it.

AF: Alarm Flag bit. When an alarm interrupt event occurs, it will be set to “1” and keeps “1” until a “0” is written to it.

VLF: Voltage Low Flag bit. When V_{CORE} (Chip internal voltage) is lower than V_{low}, it will be set to “1” and keeps “1” until a “0” is written to it.

VDET: Voltage Detection Flag bit. When V_{DD} is lower than V_{det}, it will be set to “1” and keeps “1” until a “0” is written to it.

6.2.6 Control registers

| Address | Function | bit7 | bit6 | bit5 | bit4 | bit3 | bit2 | bit1 | bit0 | Default |
|---------|----------|------|------|------|------|------|------|------|-------|---------|
| 0x0F | Control | CSEL | CSEL | UIE | TIE | AIE | ○ | ○ | RESET | 0x40 |
| 0x1F | Register | [1] | [0] | | | | | | | |

CSEL[1], CSEL[0]: Compensation interval Select 1, 0 bits, used to set temperature compensation interval.

| CSEL[1] | CSEL[0] | Compensation interval |
|---------|---------|-----------------------|
| 0 | 0 | 0.5s |
| 0 | 1 | 2s(default) |
| 1 | 0 | 10s |
| 1 | 1 | 30s |

UIE: Update Interrupt Enable bit. When UF changes from “0” to “1”, this bit controls if an interrupt signal is generated. 0-disable (/INT keeps Hi-Z), 1-enable (/INT status changes from Hi-Z to Low).

TIE: Timer Interrupt Enable bit: When TF changes from “0” to “1”, this bit controls if an interrupt signal is generated. 0-disable (/INT keeps Hi-Z), 1-enable (/INT status changes from Hi-Z to Low).

AIE: Alarm Interrupt Enable bit: When AF changes from “0” to “1”, this bit controls if an interrupt signal is generated. 0-disable (/INT keeps Hi-Z), 1-enable (/INT status changes from Hi-Z to Low).

RESET: Reset IC, prepared for the synchronized starting of time or timer.

6.2.7 Temperature register

| Address | Function | bit7 | bit6 | bit5 | bit4 | bit3 | bit2 | bit1 | bit0 | Default |
|---------|----------|------|------|------|------|------|------|------|------|---------|
| 0x17 | TEMP | 128 | 64 | 32 | 16 | 8 | 4 | 2 | 1 | 0x00 |

$$\text{Temperature}[^{\circ}\text{C}] = (\text{TEMP}[7:0] * 2 - 187.19) / 3.218 \quad \text{3BEY000Y00CA} / \text{3BEY000Y00SA}$$

6.2.8 Battery Backup switchover register

| Address | Function | bit7 | bit6 | bit5 | bit4 | bit3 | bit2 | bit1 | bit0 | Default |
|---------|--------------------|-----------|------|------|------|----------|-------|-----------|-----------|---------|
| 0x18 | Backup Function | ○ | ○ | ○ | ○ | VDET OFF | SWOFF | BKSMP [1] | BKSMP [0] | 0x00 |
| 0x21 | Control Register 1 | Reserved: | | | | | | | VBAT_S W | 0x00 |

This register controls the power switchover function. Once abnormal V_{DD} is detected, it will be switched to use battery as the power supply.

VDETOFF (Voltage Detector OFF): Main power supply V_{DD} voltage detection control bit. 0-enable detection function (Default), V_{DD} voltage will be detected once a second; 1-disable detection function.

SWOFF (Switch OFF): SW1 control bit. 0- SW1 controlled by swsel[1:0], 1- SW1 turn on.

BKSMP[1:0] (Backup mode Sampling time): Control the voltage detection sampling time. Default: 00.

VBAT_SW: K2 Switch control bit between VBAT and V_{CORE}. Default 0, 0-K2 is open. 1- K2 is close.

Table12. V_{DD} Voltage Sampling Time

| VDD Detect Function | VDETOFF | SWOFF | VBAT_SW | BKS MP [1] | BKSMP [0] | V _{DD} Voltage Sampling Time | Switch K1 ON/OFF | Switch K2 ON/OFF | Notes |
|---------------------|---------|-------|---------|------------|-----------|---------------------------------------|------------------|------------------|---------------|
| ON | 0 | X | X | 0 | 0 | 2ms | 2ms OFF | | Default |
| | | | X | 0 | 1 | 16ms | 16ms OFF | | |
| | | | X | 1 | 0 | 128ms | 128ms OFF | | |
| | | | X | 1 | 1 | 256ms | 256ms OFF | | |
| OFF | 1 | 0 | 0 | X | X | OFF | ON | OFF | SW1 Close |
| | | 0 | 1 | X | X | OFF | ON | ON | SW1/SW2 Close |
| | | 1 | X | X | x | OFF | OFF | ON | SW1 Open |

6.2.9 Device ID register

| Address | Function | bit7 | bit6 | bit5 | bit4 | bit3 | bit2 | bit1 | bit0 | Default |
|---------|-----------|---------------|------|------|------|----------|------|------|------|---------|
| 0x20 | Device ID | VendorID[3:0] | | | | Ver[3:0] | | | | 0xD1 |

VendorID[3:0]: The fixed value is defined as VendorID[3:0]=1101b=Dh to represent DAPU.

Ver[3:0]: version of the IC

6.2.10 Sub-second timer register

| Address | Function | bit7 | bit6 | bit5 | bit4 | bit3 | bit2 | bit1 | bit0 | Default |
|---------|----------|----------|------|------|------|-------------|------|------|------|---------|
| 0x27 | SubSEC | Reserved | | | | SubSEC[3:0] | | | | 0x00 |

SubSEC[3:0]: sub second bit, and unit is 1/16s.

7 I²C Bus Interface

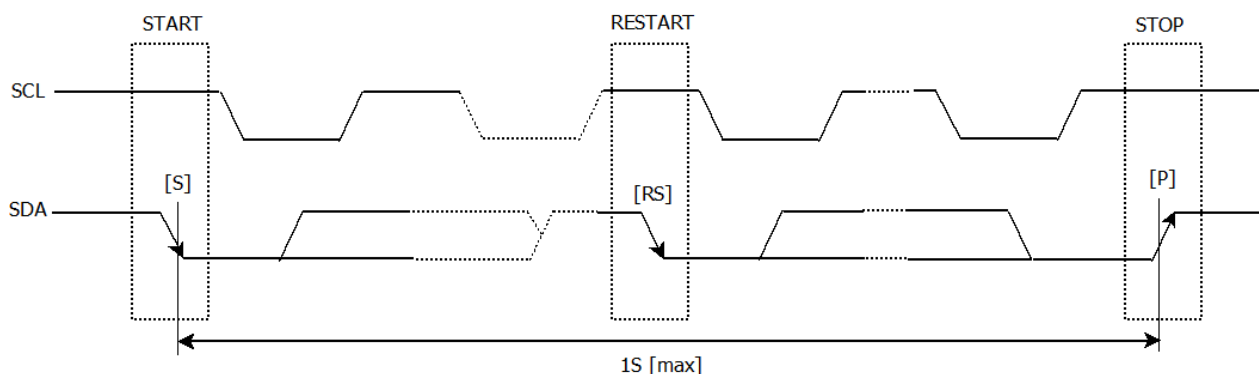

I²C bus supports bi-directional communications through a serial clock line SCL and a serial data line SDA. I²C bus device can be defined as “Master” and “Slave”. INS5T8900 can only be used as Slave.

7.1 Cautions

I²C bus includes START, RESTART, STOP conditions, the duration between START and STOP must be less than 1 second just in case the bus to be set to standby mode automatically. A new START condition must be transferred before restarting of any communications.

INS5T8900 I²C bus interface supports single byte read/write operations as well as multiple bytes incremental access. After 0xFF address, the next one will be 0x00.

7.2 Slave Address

Table13. I²C Bus Slave Address

| Transfer data | Slave address | | | | | | | R/W |
|---------------|---------------|------|------|------|------|------|------|-----------|
| | bit7 | bit6 | bit5 | bit4 | bit3 | bit2 | bit1 | bit0 |
| 65h (Read) | 0 | 1 | 1 | 0 | 0 | 1 | 0 | 1 (Read) |
| 64h (Write) | | | | | | | | 0 (Write) |

INS5T8900 I²C bus Slave Address is [0110 010*].

7.3 I²C bus protocol

It is assumed CPU is master and INS5T8900 is slave in this section.

7.3.1 Write process

I²C bus includes an address auto-increment function, once the initial address has been specified, the INS5T8900 increments (+1) the address automatically after each data is sent, then to write next data.

- (1) CPU sends start condition[S]
- (2) CPU sends INS5T8900's slave address with R/W bit to set to write mode
- (3) CPU verifies ACK signal from INS5T8900
- (4) CPU sends write address to INS5T8900
- (5) CPU verifies ACK signal from INS5T8900
- (6) CPU sends write data to the address specified at step (4)
- (7) CPU verifies ACK signal from INS5T8900
- (8) Repeat (6) (7) if multiple bytes need to be written, address will be incremented automatically
- (9) CPU ends stop condition[P]

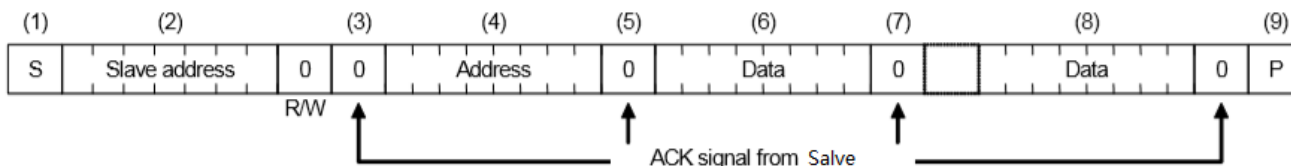

7.3.2 Read process

Writing the address to be read with write mode firstly, then reading the data with read mode.

- (1) CPU sends start condition[S]
- (2) CPU sends INS5T8900's slave address with R/W bit to set to write mode
- (3) CPU verifies ACK signal from INS5T8900
- (4) CPU sends address for reading from INS5T8900
- (5) CPU verifies ACK signal from INS5T8900
- (6) CPU sends RESTART condition [Sr]
- (7) CPU sends INS5T8900's slave address with R/W bit to set to read mode
- (8) CPU verifies ACK signal from INS5T8900
- (9) CPU reads data from the specified address in step (4)
- (10) CPU sends ACK signal for "0"
- (11) Repeat (9) (10) if multiple bytes need to be read, address will be incremented automatically
- (12) CPU sends ACK signal for "1"
- (13) CPU sends stop condition[P]

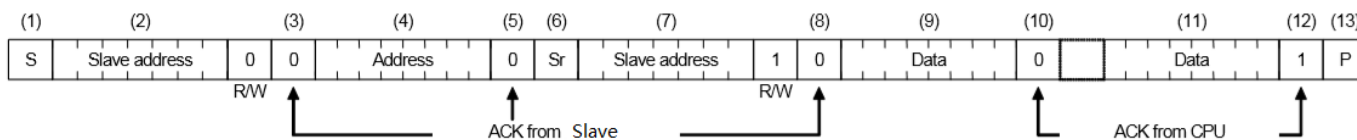

8 Reflow Soldering Curve

Standard: IPC/JEDEC J-STD-020



Figure 3. Reflow Soldering Curve

Note: It is suggested to solder IC under the condition shown in the curve above. Must pay attention to the temperature and time when manual soldering, if the temperature over +260°C, or you will make the xo performance bad, even damage it.

9 Dimensions

MPN: INS5T8900-3BEY000Y00CA / 3BEX000Y00CA / 3BZY000Y00CA

| Dimension | Min. | Typ. | Max. |
|-----------|------|------|------|
| A | 3.1 | 3.2 | 3.3 |
| B | 2.4 | 2.5 | 2.6 |
| C | 0.8 | 0.9 | 1.0 |
| D | -- | 0.45 | -- |
| E | -- | 1.4 | -- |
| F1 | -- | 0.4 | -- |
| F2 | -- | 0.3 | -- |
| G | -- | 0.6 | -- |
| H | -- | 1.3 | -- |

unit: mm

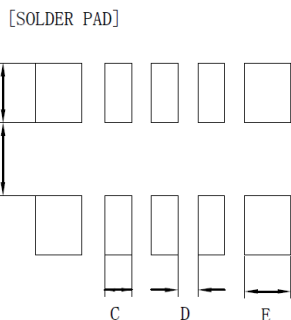
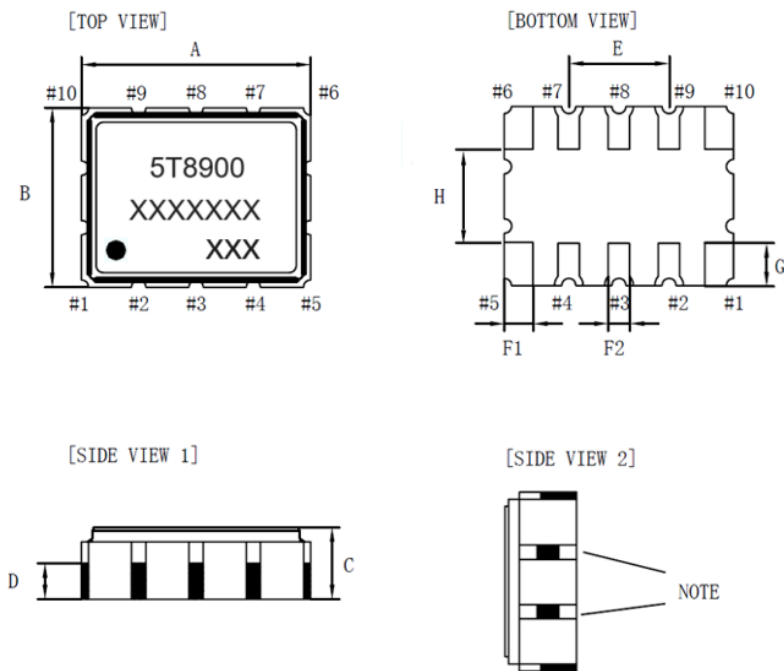

| Dimension | Recommend |
|-----------|-----------|
| A | 0.9 |
| B | 1.1 |
| C | 0.4 |
| D | 0.3 |
| E | 0.7 |

unit: mm

Figure 4. Dimensions and Recommended Solder Pad

Note:

1. The metal surface on the side shown in the figure is used for crystal test. Please avoid short circuit caused by contact between the metal surface and other electrical networks or other device surfaces during design and assembly.
2. The unnoted tolerance is $\pm 0.1\text{mm}$.

MPN: INS5T8900-3BEY000Y00SA / 3BEX000Y00SA / 3BZY000Y00SA

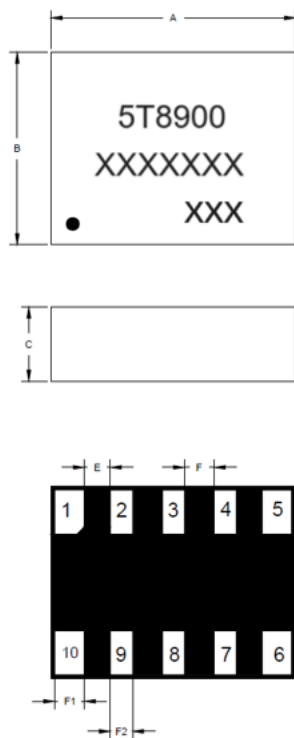

| Dimension | Min. | Typ. | Max. |
|-----------|------|------|------|
| A | 3.0 | 3.2 | 3.4 |
| B | 2.3 | 2.5 | 2.7 |
| C | -- | 1.0 | -- |
| E | -- | 0.3 | -- |
| F | -- | 0.4 | -- |
| G | -- | 0.6 | -- |
| H | -- | 1.3 | -- |
| F1 | -- | 0.45 | -- |
| F2 | -- | 0.3 | -- |

Unit: mm

Figure 5. Dimension

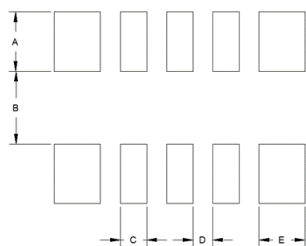

| Dimension | Max. |
|-----------|------|
| A | 0.9 |
| B | 1.1 |
| C | 0.4 |
| D | 0.3 |
| E | 0.7 |

Unit: mm

Figure 6. Recommended Soldering Pattern

10 Package

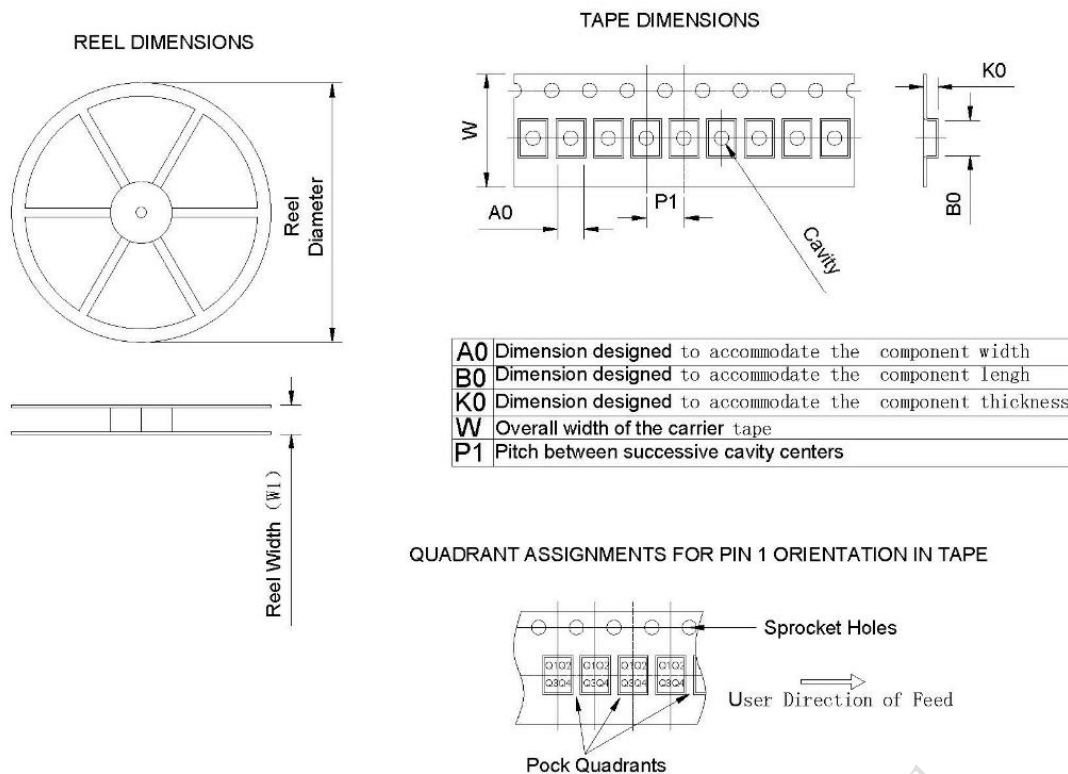

Figure 7. Package

| Device | Package Type | Pins | SPQ | Reel Diameter (mm) | Reel Width W1(mm) | A0 (mm) | B0 (mm) | K0 (mm) | P1 (mm) | W (mm) | PIN1 Quadrant |
|--------------------------|--------------|------|------|--------------------|-------------------|---------|---------|---------|---------|--------|---------------|
| INS5T8900-3BEY000Y00CA | Ceramic | 10 | 3000 | 180 | 11.6±2.0 | 3.00 | 3.70 | 1.50 | 4 | 8.00 | Q1 |
| INS5T8900-3BEX000Y00CA / | Ceramic | 10 | 3000 | 180 | 11.6±2.0 | 3.00 | 3.70 | 1.50 | 4 | 8.00 | Q1 |
| INS5T8900-3BZY000Y00CA / | Ceramic | 10 | 3000 | 180 | 11.6±2.0 | 3.00 | 3.70 | 1.50 | 4 | 8.00 | Q1 |
| INS5T8900-3BEY000Y00SA / | LGA | 10 | 3000 | 180 | 11.6±2.0 | 3.00 | 3.70 | 1.50 | 4 | 8.00 | Q1 |
| INS5T8900-3BEX000Y00SA / | LGA | 10 | 3000 | 180 | 11.6±2.0 | 3.00 | 3.70 | 1.50 | 4 | 8.00 | Q1 |

| | | | | | | | | | | | |
|------------------------------|-----|----|------|-----|----------|------|------|------|---|------|----|
| INS5T8900- 3BZY000Y00SA / | LGA | 10 | 3000 | 180 | 11.6±2.0 | 3.00 | 3.70 | 1.50 | 4 | 8.00 | Q1 |
|------------------------------|-----|----|------|-----|----------|------|------|------|---|------|----|

FOR dptel

11 Revision History

| Version | Change Contents | Prepared by | Revised Date |
|---------|-----------------|-------------|--------------|
| V1.0 | First Issued | | 2024.05.24 |
| | | | |
| | | | |
| | | | |
| | | | |

FOR dptel