



To Customer: _____

Temperature Compensated Crystal Oscillator (TCXO)

INS9A8804

Datasheet

Document Version 1.0

Released on November 16th, 2023

Ordering Information

Manufacture Part Number	Product Name	Description
INS9A8804-6BWY000N00SA	INS9A8804	SMD3225, $\pm 5\text{ppm}$ @ $-40^{\circ}\text{C} \sim +90^{\circ}\text{C}$ $\pm 20\text{ppm}$ @ $+90^{\circ}\text{C} \sim +105^{\circ}\text{C}$

Guangdong Dapu Telecom Technology Co., Ltd

Bldg 5, SSL Modern Enterprise Accelerator Zone, Dongguan City, Guangdong Province, PRC China

TEL:0086-0769-88010888

FAX:0086-0769-81800098

Key Features

- Low current consumption: 1.8uA (Typ.)
- High stability:
 - ±5ppm @ -40°C~+90°C
 - ±20ppm @ +90°C~+105°C
- Power Supply Voltage: 1.8V~5.5V
- Operation Temperature Range: -40°C~+105°C
- Package: 3.2mm × 2.5mm × 0.9mm
- AEC-Q100 Compliant
- RoHS2.0 & REACH compliant

Block Diagram

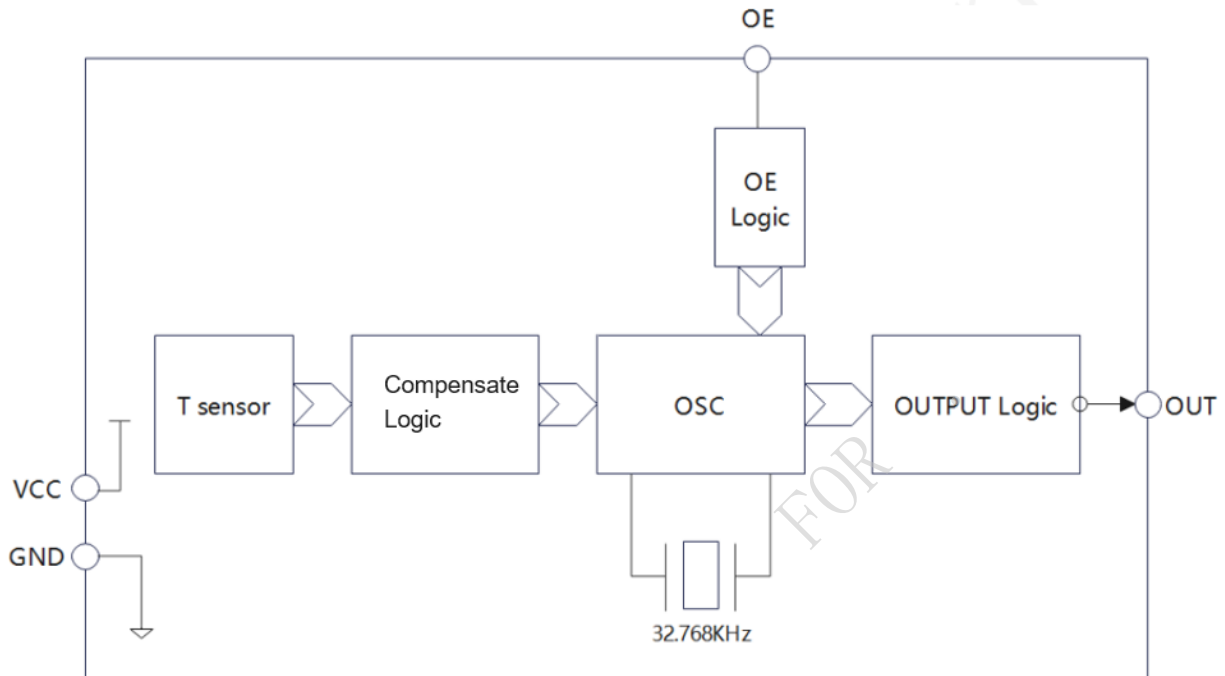

Overview

INS9A8804 is a low power consumption and wide temperature range TCXO. The SMD3225 package with only 0.9mm thickness and AEC-Q100 compliant makes it suitable for automotive applications.



CONTENTS

CONTENTS	3
1 PIN DEFINITION	4
2 ELECTRICAL CHARACTERISTICS	5
2.1 ABSOLUTE MAXIMUM RATINGS	5
2.2 RECOMMENDED OPERATING CONDITIONS.....	5
2.3 FREQUENCY CHARACTERISTICS	5
2.4 DC CHARACTERISTICS	6
3 REFLOW SOLDERING CURVE	7
4 DIMENSIONS	8
5 PACKAGE	9
6 REVISION HISTORY	10



1 Pin definition

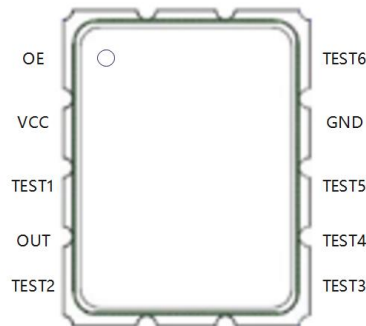

Table1. Pin Definition

Pin Number	Pin Name	I/O	Description
1	OE	In	OUT control pin. “1”- enable OUT, “0”-OUT Hi-Z. OE pin is active HIGH input, Do not leave floating.
2	V _{cc}	-	Power supply
3	TEST1	-	For manufacture test, suggest to connect to GND or keep floating. If this pin connects to VCC, the power consumption will increase to about 8uA.
4	OUT	Out	Frequency output (CMOS). Controlled by OE.
5	TEST2	-	For manufacture test, connect to GND.
6	TEST3	-	For manufacture test, connect to GND or keep floating.
7	TEST4	-	For manufacture test, connect to GND.
8	TEST5	-	For manufacture test, connect to GND or keep floating.
9	GND	-	Ground
10	TEST6	-	For manufacture test, connect to GND or keep floating.



2 Electrical Characteristics

2.1 Absolute Maximum Ratings

Table2. Absolute Maximum Ratings

Parameter	Symbol	Value			Unit	Notes
		Min.	Typ.	Max.		
Power Supply Voltage	V _{cc}	-0.3		6.5	V	
Input Voltage	V _{IN}	GND-0.3		6.5	V	OE
Output Voltage	V _{OUT}	GND-0.3		V _{DD} +0.3	V	OUT
Storage temperature	T _{STG}	-55		125	°C	

2.2 Recommended Operating Conditions

Table3. Recommended Operating Conditions

Parameter	Symbol	Value			Unit	Notes
		Min.	Typ.	Max.		
Power Supply Voltage	V _{CC}	1.8	3.0	5.5	V	
Current consumption	I _{DD}		1.8		uA	@25°C, V _{CC} =3V
Operation temperature	T _{OPR}	-40	25	105	°C	
Output Load	L _{CMOS}			30	pF	

Note 1: After power off, ensure that V_{CC}=GND for more than 10 seconds before next power on cycle.

2.3 Frequency Characteristics

Table4. Frequency Characteristics

Parameter	Symbol	Value			Unit	Notes
		Min.	Typ.	Max.		
Output Frequency	f _{out}	-	32.768	-	kHz	
Frequency stability	Δf/f	-5		+5	ppm	-40°C~+90°C
Frequency stability	Δf/f	-20		+20	ppm	+90°C~+105°C
Frequency vs voltage	f-vcc	-1		+1	ppm	V _{cc} =1.8V~5.5V
Oscillation start time	t _{STA}			1	s	@25°C, V _{cc} =3V
				3		@-40°C~105°C, V _{cc} =3V
Year Aging	f _a	-5		+5	ppm	@25°C, First year



Parameter	Symbol	Value			Unit	Notes
		Min.	Typ.	Max.		
OUT duty cycle	$t_{w/t}$	40	50	60	%	

2.4 DC Characteristics

Table5. DC Characteristics

Parameter	Symbol	Value			Unit	Notes	
		Min.	Typ.	Max.			
Average Current consumption1	I_{CC1}		1.9	26	uA	$V_{CC}=5.0V$	OE=GND, OUT: Hi-Z
Average Current consumption2	I_{CC2}		1.8	25			
Average Current consumption3	I_{CC3}		4.8	30	uA	$V_{CC}=5.0V$	OE= V_{CC} , OUT:32.768kHz, no load;
Average Current consumption4	I_{CC4}		2.8	28			
High-level input voltage	V_{IH}	$0.8*V_{CC}$		V_{CC}	V	OE pin	
Low-level input voltage	V_{IL}	GND-0.3		$0.2*V_{CC}$	V		
High-level output voltage	V_{OH1}	4.0		5.0	V	$V_{CC} = 5.0V, I_{OH} = -1mA$	OUT pin
	V_{OH2}	2.2		3.0		$V_{CC} = 3.0V, I_{OH} = -1mA$	
Low-level output voltage	V_{OL1}	GND		GND+0.5	V	$V_{CC} = 5.0V, I_{OL} = 1mA$	OUT pin
	V_{OL2}	GND		GND+0.8		$V_{CC} = 3.0V, I_{OL} = 1mA$	
Input leakage current	I_{LK}	-0.5		0.5	uA	OE pin, $V_{IN} = V_{CC}$ or GND	



3 Reflow Soldering Curve

Standard: IPC/JEDEC J-STD-020

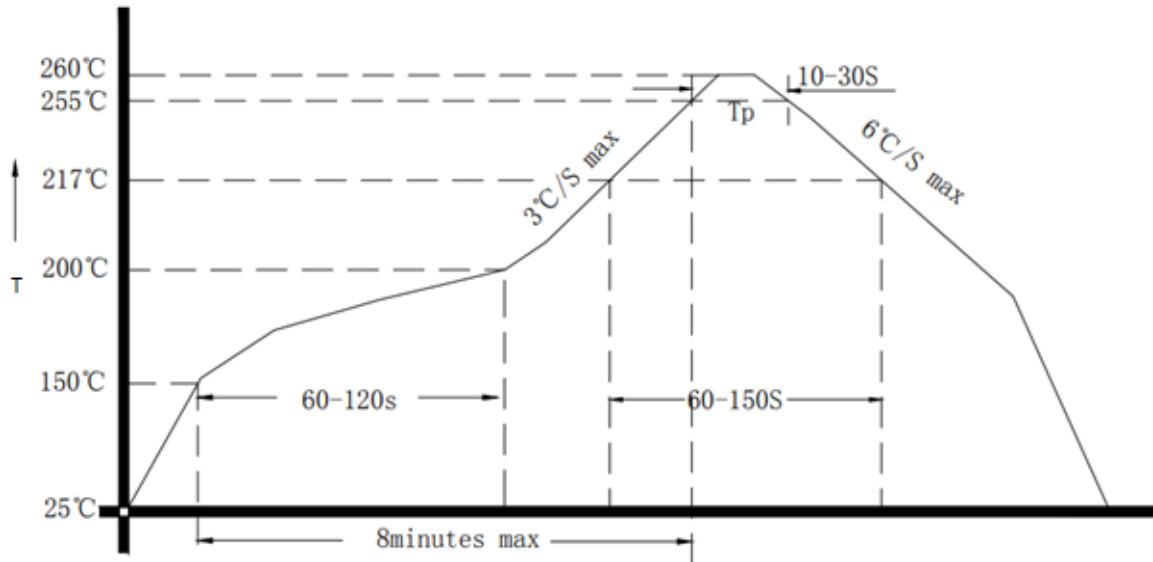
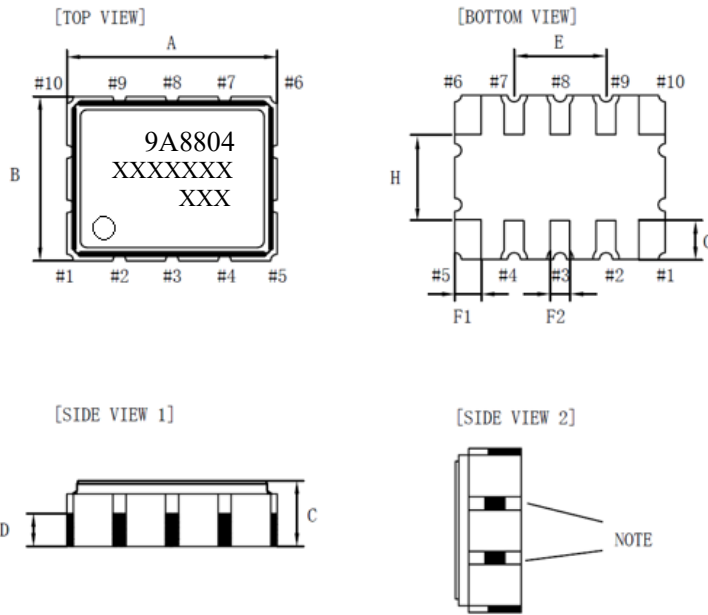

Figure 1. Reflow Soldering Curve

Note: It is suggested to solder IC under the condition shown in the curve above. Must pay attention to the temperature and time when manual soldering, if the temperature over +260°C, or you will make the xo performance bad, even damage it.



4 Dimensions



Dimension	Min.	Typ.	Max.
A	3.1	3.2	3.3
B	2.4	2.5	2.6
C	0.8	0.9	1.0
D	--	0.45	--
E	--	1.4	--
F1	--	0.4	--
F2	--	0.3	--
G	--	0.6	--
H	--	1.3	--

unit: mm

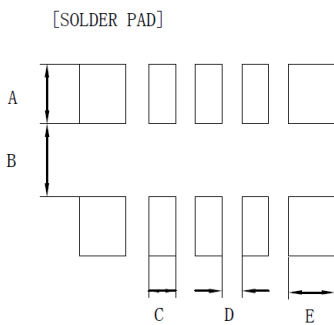

Dimension	Recommend
A	0.9
B	1.1
C	0.4
D	0.3
E	0.7

unit: mm

Note: The metal surface on the side shown in the figure is used for crystal test. Please avoid short circuit caused by contact between the metal surface and other electrical networks or other device surfaces during design and assembly.

Figure 2. Recommended Solder Pad and Dimensions



5 Package

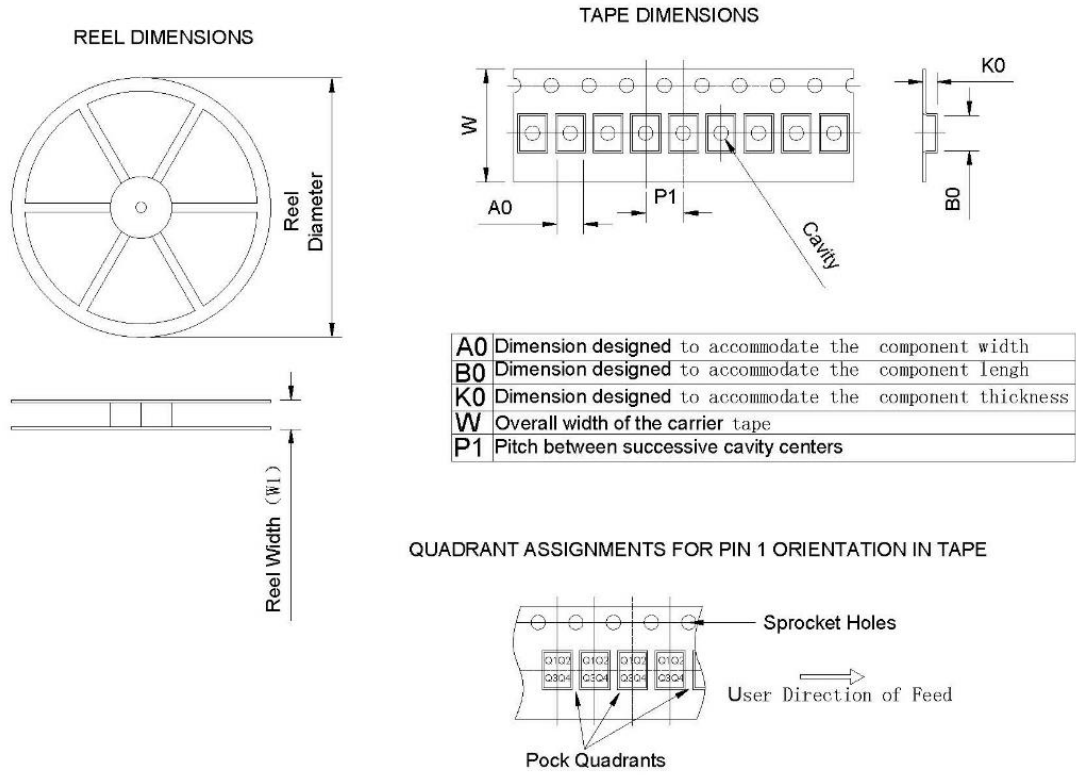

A0	Dimension designed to accommodate the component width
B0	Dimension designed to accommodate the component length
K0	Dimension designed to accommodate the component thickness
W	Overall width of the carrier tape
P1	Pitch between successive cavity centers

QUADRANT ASSIGNMENTS FOR PIN 1 ORIENTATION IN TAPE

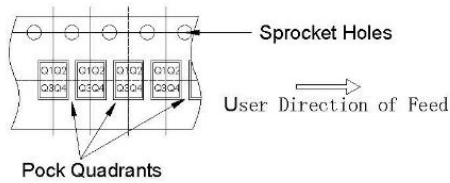

Device	Package Type	Pins	SPQ	Reel Diameter (mm)	Reel Width W1(mm)	A0 (mm)	B0 (mm)	K0 (mm)	P1 (mm)	W (mm)	PIN1 Quadrant
INS9A8804	Ceramic	10	3000	180	11.6±2.0	3.00	3.70	1.50	4	8.00	Q1

Figure 3. Package



6 Revision History

Version	Change Contents	Prepared by	RevisedDate
V1.0	First issued		2023.11.16