

Travelling Merchant: _____

DATASHEET

Standard: **T75B-B319-38.88MHz**

P/N: _____

Plot			The Label
Drew	Audited	Approved	Stamp, please! Thanks!
Date: 2021.01.15			

Guangdong Dapu Telecom Technology Co.,Ltd

Bldg13-16,.N.Ind.Zone,SSL Industry Park, Dongguan City, Guangdong Province, China

TEL: 0086-0769-88010888 FAX: 0086-0769-81800098



1. Electrical Parameters

MODEL: T75B-B319-38.88MHz						
Item	Description	Parameters			Unit	Test Condition
		Min.	Typ.	Max.		
Output	Frequency	38.88			MHz	
	Output Waveform	HCMOS				
	Output Low Voltage			0.4	V	$V_{cc}=3.3V, O_{load}=15\text{ pF}$
	Output High Voltage	2.4			V	$V_{cc}=3.3V, O_{load}=15\text{ pF}$
	Duty Cycle	45	50	55	%	@50%
	Rise / Fall Time (10%~90%)			8	ns	@25°C
	Load	15			pF	
Frequency Stabilities	Frequency Tolerance vs. Operating Temperature Range	-0.28		+0.28	$\times 10^{-6}$	T_A varied from -40°C to 105°C, measurement referenced to frequency observed with $f_{ref}=(f_{max}+f_{min})/2, V_{cc}=3.3V, O_{load}=15\text{ pF}$, temperature variable speed less than 2°C per minute.
	Initial Frequency Tolerance	-1		+1	$\times 10^{-6}$	Measurement referenced to frequency observed with $T_A=25^\circ\text{C}, V_{cc}=3.3V$ within 30 days after ex-works.
	Frequency Tolerance vs. Supply Voltage	-0.1		+0.1	$\times 10^{-6}$	measurement referenced to frequency observed $T_A=25^\circ\text{C}, V_{cc}$ varied from 3.13V to 3.47V, and $O_{Load}=15\text{ pF}$.
	Frequency Tolerance vs. Load	-0.1		+0.1	$\times 10^{-6}$	5% load change measurement referenced to frequency observed with $T_A=25^\circ\text{C}, V_{cc}=3.3V, O_{Load}=15\text{ pF}$.
	Aging Tolerance Per Day	-0.01		+0.01	$\times 10^{-6}$	$T_A=25^\circ\text{C}, V_{cc}=3.3V$, and after 1h of operation.
	Aging Tolerance 1 Year	-1		+1	$\times 10^{-6}$	
Power Supply	Current Consumption			10	mA	@25°C, $V_{cc}=3.3V, O_{Load}=15\text{ pF}$.
	Supply Voltage	3.13	3.3	3.47	V	



Phase Noise	Phase Noise @25°C		-90	-85	dBc/Hz	10Hz
			-115	-110		100Hz
			-135	-130		1KHz
			-148	-143		10KHz
			-150	-145		100KHz
			-151	-146		1MHz
Environmental Conditions	Operable Temperature	-40		+105	°C	
	Storage Temperature	-55		+105	°C	
	ESD Level	Human Body Model,class2: 2000V to 4000V; ANSI/ESDA/JEDEC JS-001-2010.				
		Machine Model, class B: 200V to 400V; JEDEC JESD22-A115C.				
	Moisture Sensitivity Level	Level 3.				
	Vibration	Test Condition: 0.75mm ;acceleration:10g;10Hz~2000Hz, one cycle per 30 min, test 2 hour. (3 times for each 3 directions X , Y , Z) .IEC 68-2-06 Test Fc.				
Shock	100g; 6ms; half sine wave (3 times for each 3 directions X , Y , Z),IEC 68-2-27 Test Ea/Severity 50A.					



2. Mechanical Structure(mm)

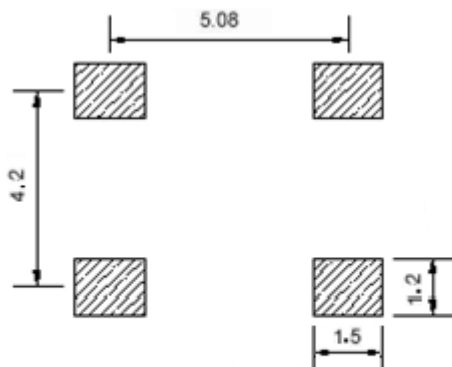

Solder pad layout

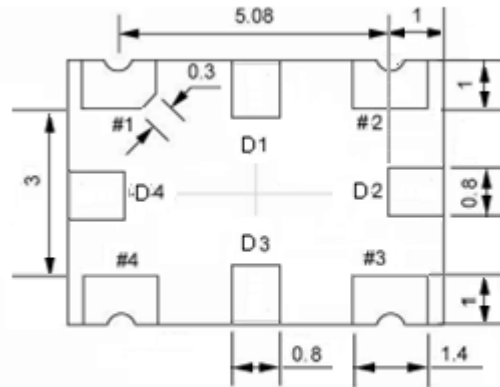

Bottom view



Right view



Side view

PIN FUNCTION

PIN	FUNCTION
D1, D2, D3, D4	NC
1	NC
2	GND
3	OUTPUT
4	VCC

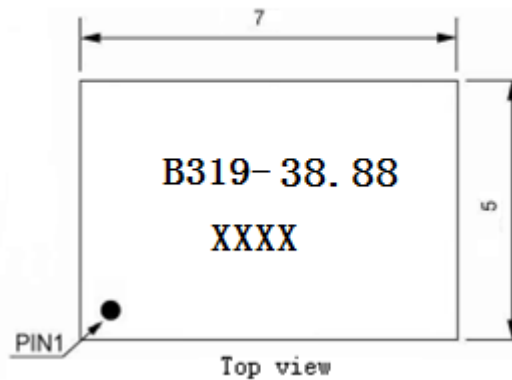

Top view

- Note1:** Tolerance $\pm 0.2\text{mm}$ without mark
- Note2:** Referential Weight 0.2g
- Note3:** The first two xx representative: week
After two xx representative: year
- Note4:** NC is not connect



3. Test circuit

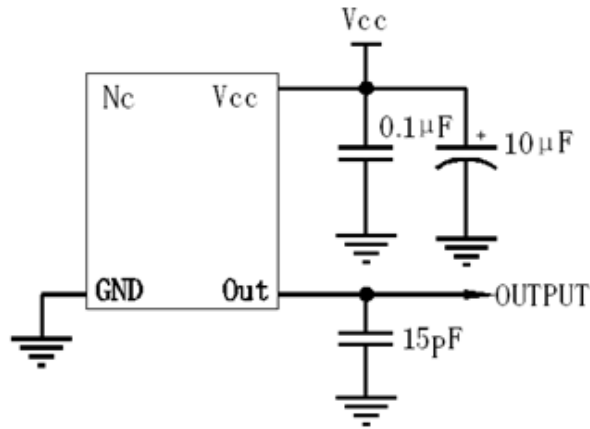

4. Reflow Soldering Curve (RoHS)

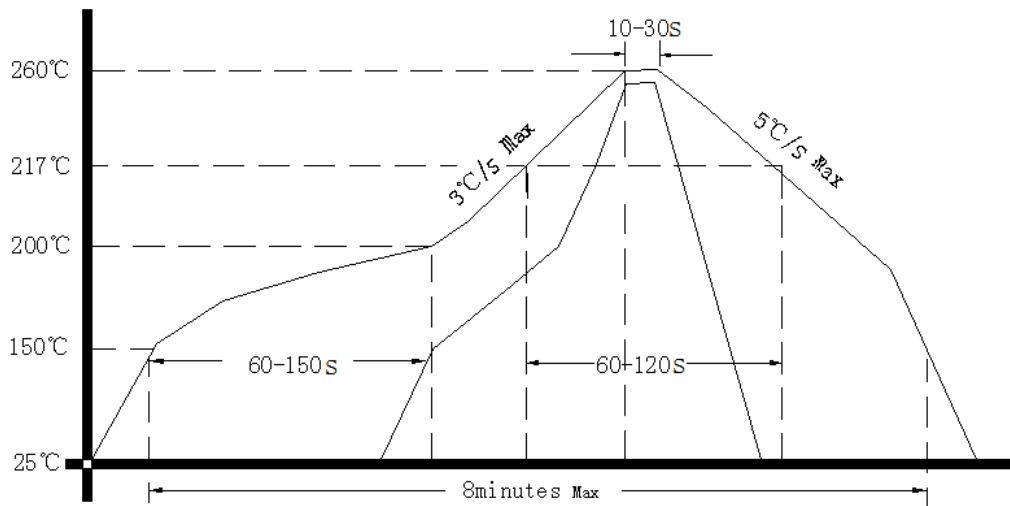

5. Package: Tape & Reel (mm)

