

Travelling Merchant: _____

DATASHEET

Standard: **O75A-L319-40.00MHz-S664**

P/N: _____

Plot			The Label
Drew	Audited	Approved	Stamp, please! Thanks!
Date: 2024.05.08			

Guangdong Dapu Telecom Technology Co.,Ltd

Building 5, No.24, Industrial East Road, Songshanhu Park, Dongguan, Guangdong, P.R. China

TEL: 0086-0769-88010888 FAX: 0086-0769-81800098



1. Electrical Parameters

MODEL: O75A-L319-40.00MHz-S664						
Item	Description	Parameters			Unit	Test Condition
		Min.	Typ.	Max.		
Output	Frequency	40.00			MHz	
	Output Waveform	HCMOS				
	Output Low Voltage			0.4	V	$V_{cc}=3.3V, O_{load}=15\text{ pF}$
	Output High Voltage	2.4			V	$V_{cc}=3.3V, O_{load}=15\text{ pF}$
	Duty Cycle	45		55	%	@50%
	Rise / Fall Time			5	ns	10%~90%
	Startup time till valid waveform			15	ms	Time until RF output waveform is within output level, duty cycle and rise/fall time spec
	Load	15			pF	
Frequency Stabilities	Frequency Tolerance vs. Operating Temperature Range	-0.05		+0.05	$\times 10^{-6}$	T_A varied from -40°C to 105°C , measurement referenced to frequency observed with $f_{ref}=(f_{max}+f_{min})/2, V_{cc}=3.3V, O_{load}=15\text{ pF}$, temperature variable speed less than 2°C per minute.
	Initial Frequency Tolerance	-1.5		+1.5	$\times 10^{-6}$	Measurement referenced to frequency observed with $T_A=25^\circ\text{C}, V_{cc}=3.3V$ within 30 days after ex-works.
	Frequency Tolerance vs. Supply Voltage	-0.01		+0.01	$\times 10^{-6}$	measurement referenced to frequency observed $T_A=25^\circ\text{C}, V_{cc}$ varied from 3.135V to 3.465V, and $O_{Load}=15\text{ pF}$.
	Frequency Tolerance vs. Load	-0.01		+0.01	$\times 10^{-6}$	5% load change measurement referenced to frequency observed with $T_A=25^\circ\text{C}, V_{cc}=3.3V, O_{Load}=15\text{ pF}$.
	Short-Term Stability Allan Variance			0.05	$\times 10^{-9}$	Temperature stability, no EMI\EMC or other interference, test after power for 1hour ref. to $25^\circ\text{C}; 1\text{ s}$.
	Aging Tolerance Per Day	-3		+3	$\times 10^{-9}$	$T_A=25^\circ\text{C}, V_{cc}=3.3V$, and after 30days of operation.
	Aging Tolerance Per Year	-0.3		+0.3	$\times 10^{-6}$	



Power Supply	Steady Consumption			230	mA	@25°C
	Warm up current			600	mA	
	Supply Voltage	3.135	3.3	3.465	V	
Phase Noise	Phase Noise @25°C		-110	-100	dBc/Hz	10Hz
			-140	-130		100Hz
			-156	-151		1KHz
			-161	-156		10KHz
			-161	-156		100KHz
			-161	-156		1MHz
Environmental Conditions	Operable Temperature	-40		+105	°C	
	Storage Temperature	-55		+105	°C	
	ESD Level	Human Body Model,class2: 2000V to 4000V; ANSI/ESDA/JEDEC JS-001-2010.				
		Machine Model, class B: 200V to 400V; JEDEC JESD22-A115C.				
	Moisture Sensitivity Level	Level 3.				
	Vibration	Test Condition: 0.75mm ;acceleration:10g;10Hz~2000Hz, one cycle per 30 min, test 2 hour. (3 times for each 3 directions X ,Y , Z) .IEC 68-2-06 Test Fc.				
	Shock	100g; 6ms; half sine wave (3 times for each 3 directions X ,Y , Z),IEC 68-2-27 Test Ea/Severity 50A.				



2. Mechanical Structure(mm)

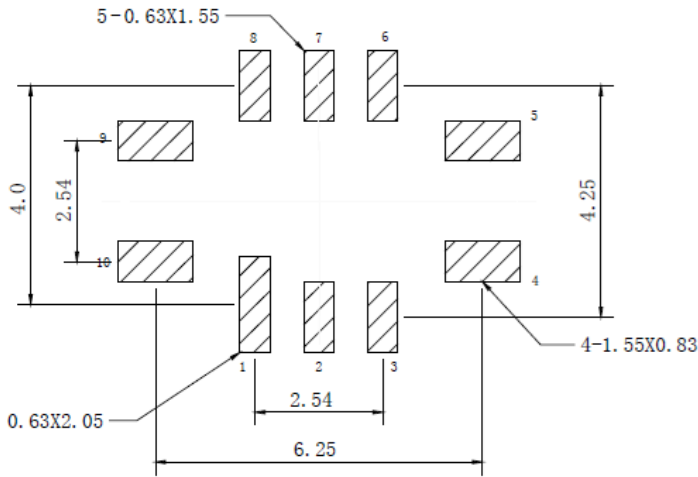

Solder pad layout

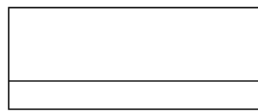

Right view

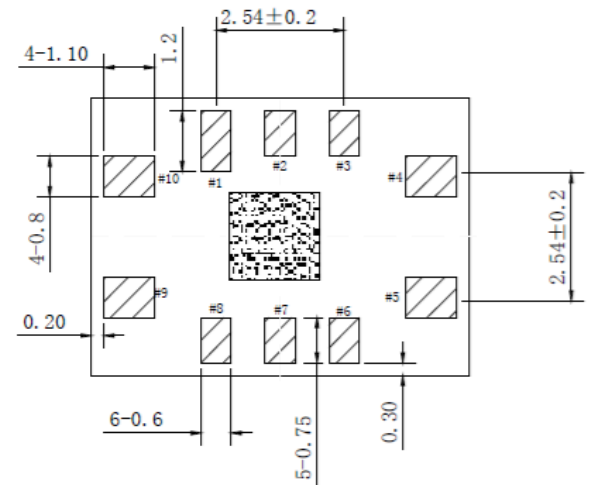

Bottom view

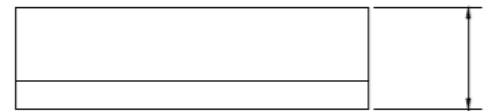

Front view

3.3±0.2

Pin Function

Pin	Function
1, 2, 3, 6, 7, 8	NC
4	GND
5	OUTPUT
9	VCC
10	NC

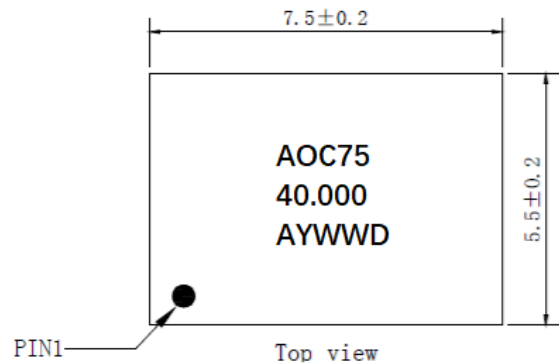

Top view

Note1: Tolerance ±0.2mm without mark

Note2: Referential Weight 0.3g

Note3: NC is not connect

Note4: "Y" = last digits of year

"WW" = Work week



3. Test circuit

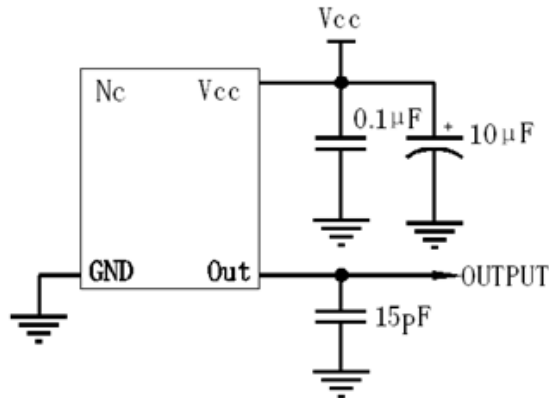

4. Reflow Soldering Curve (RoHS)

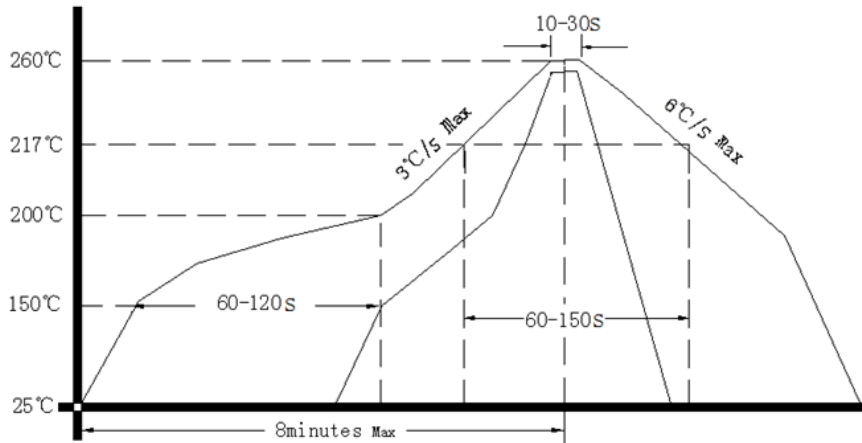

Note: Passing through reflow upside down is not supported

5. Package: Tape & Reel (mm)

