



DP3467C

ENG PART:DP-20X20CD-600T730-CW

600MHz to 730MHz Single-Junction Drop-in Circulator

REV.	DESCRIPTION	REVISOR	DATE	APPROVED
A	SAME AS REV.1	ZZ.Zhu	2024/9/12	Nick

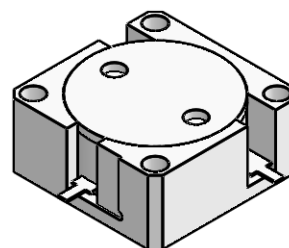

Applications:

- Wireless Infrastructure
- Power Amplifier

Features:

- Operating frequency range:600MHz to 730MHz
- Operating temperature range: -40°C to +85°C
- Storage temperature range: -50°C to +135°C
- BeO free&RoHS compliant

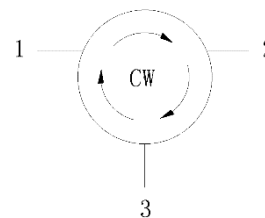

Block Diagram



Electrical Specifications:

ITEM	SPECIFICATION	
Frequency	600~730	MHz
Direction	CW	
Impedance	Typ: 50	Ω
Insertion Loss (Max.)	0.8	dB
Isolation (Min.)	12	dB
Return Loss (Min.)	12	dB
Power FWD/REV/PEAK	100/-/1000	W
Operating Temperature	-40~+85	$^{\circ}\text{C}$
Storage Temperature	-50~+135	$^{\circ}\text{C}$
Termination/Attenuator	/	W/dB

Notes:

1. Exposure to maximum rating conditions for extended periods may reduce device reliability. There is no damage to device with only one parameter set at the limit and all other parameters set at or below their nominal value. Exceeding any of the limits listed here may result in permanent damage to the device.
2. Performance is guaranteed under the conditions listed in this table and over the operating temperature range.



Mechanical Specifications:

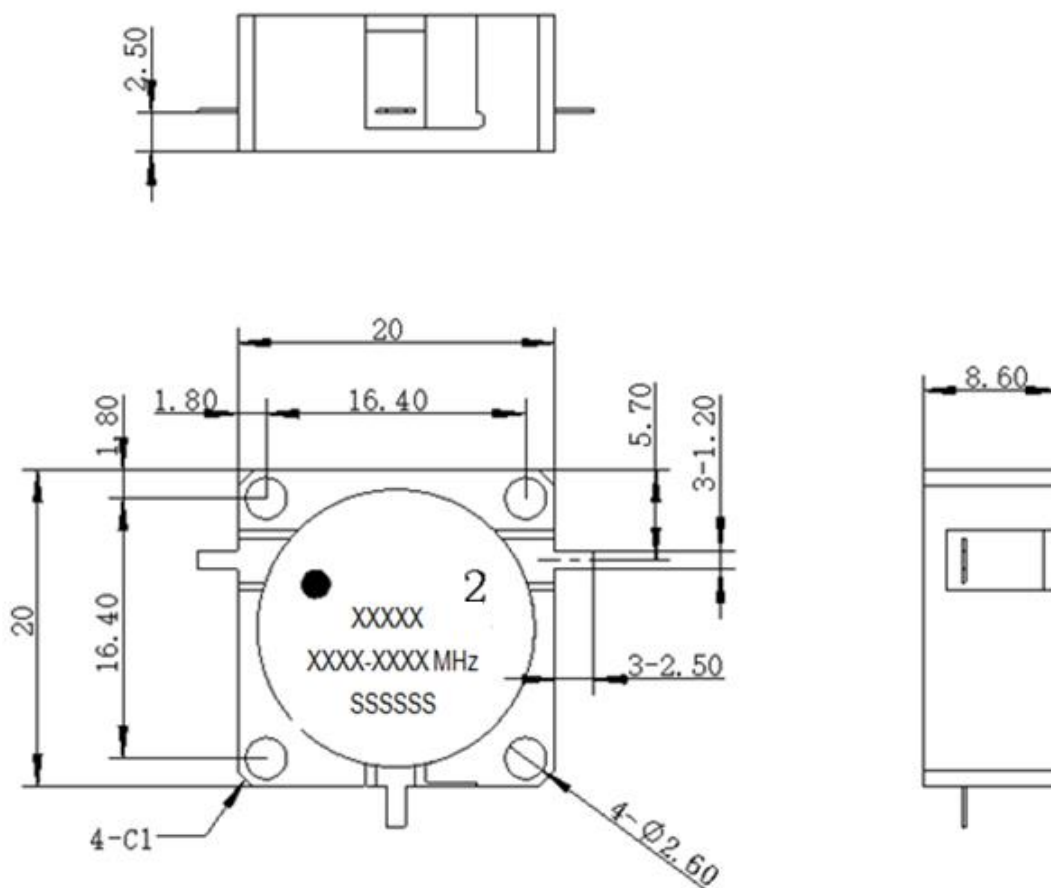

Unit: Millimeters

Notes:

1. The housing and circuit are silver-plated.
2. Tolerance ± 0.2 mm unless otherwise specified.
3. Co-planarity Specification: 0.1mm maximum.
4. Part Number, Lot Code, and Port Designation are printed on the top side of device.
5. The **XXXXX** on the label represents the last five digits of the Part Number
6. The **XXXX-XXXX** on the label represents the operating frequency
7. The **SSSSSS** on the label represents the serial number
8. The black dot on the label represents the input port