



DP3412S

ENG PART: DP-20X20ID-1000T1300-CCW

1000MHz to 1300MHz Single Junction Drop-in Isolator

REV.	DESCRIPTION	REVISOR	DATE	APPROVED
A	SAME AS REV.2	ZZ.Zhu	2024/8/13	Nick
B	Updated the label	ZC.Wu	2024/8/30	Nick

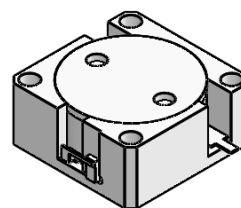

Applications:

- Wireless Infrastructure
- Power Amplifier

Features:

- Operating frequency range: 1000MHz to 1300MHz
- Operating temperature range: -40°C to +85°C
- Storage temperature range: -50°C to +125°C
- Small surface-mount package delivered on T&R
- BeO free & RoHS compliant

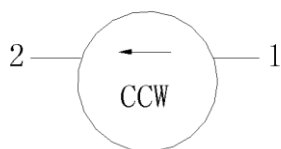

Block Diagram



Electrical Specifications:

ITEM	SPECIFICATION	
Frequency	1000~1300	MHz
Direction	CCW	
Impedance	Typ: 50	Ω
Insertion Loss (Max.)	0.5	dB
Isolation (Min.)	15	dB
Return Loss (Min.)	15	dB
3rd IMD (Max.)	-	dBc
Group delay	-	ns
2nd harmonic	-	dBc
3rd harmonic	-	dBc
Power FWD/REV/PEAK	50/20/500	W
Termination/Attenuator	30/-	W/dB
Input Impedance ,real	-	Ω
Input Impedance ,imaginary	-	Ω
Output Impedance ,real	-	Ω
Output Impedance ,imaginary	-	Ω

Notes:

1. Exposure to maximum rating conditions for extended periods may reduce device reliability. There is no damage to device with only one parameter set at the limit and all other parameters set at or below their nominal value. Exceeding any of the limits listed here may result in permanent damage to the device.
2. Performance is guaranteed under the conditions listed in this table and over the operating temperature range.



Mechanical Specifications:

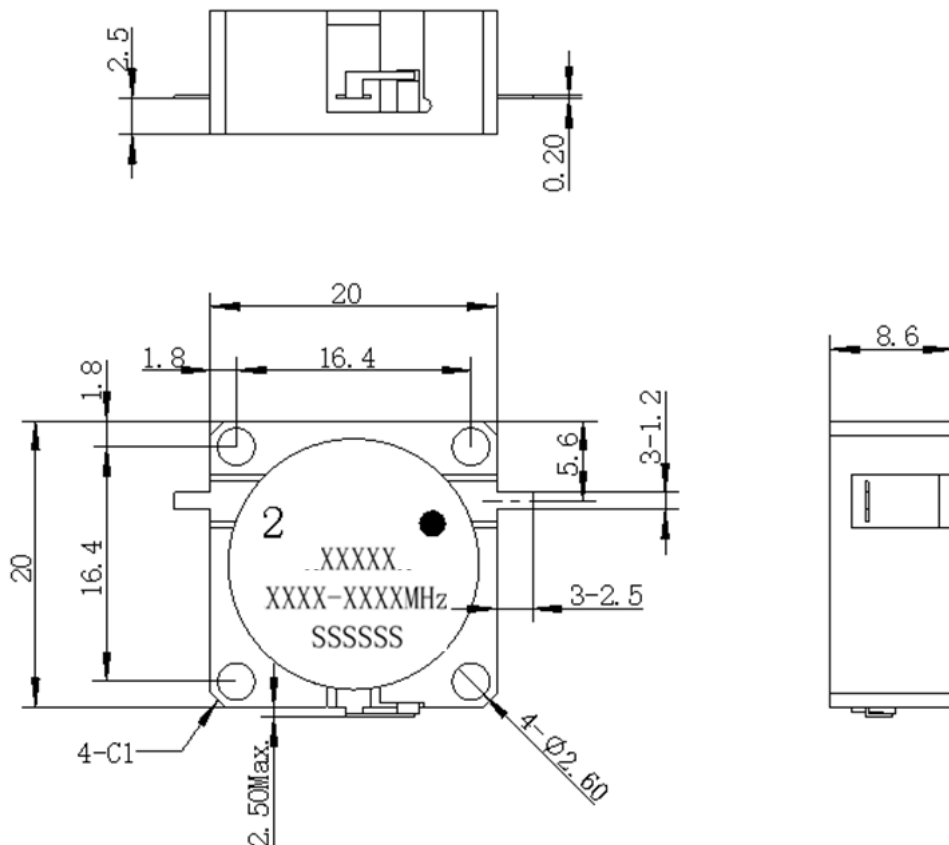

Unit: Millimeters

Notes:

1. The housing is nickel-plated and the tabs are silver-plated.
2. Tolerance ± 0.2 mm unless otherwise specified.
3. Co-planarity Specification: 0.1 mm maximum.
4. Part Number, Lot Code, and Port Designation are printed on the top side of device.
5. The XXXXX on the label represents the last five digits of the Part Number
6. The XXXX-XXXX on the label represents the operating frequency
7. The SSSSSS on the label represents the serial number
8. The black dot on the label represents the input port