



DP3237C

ENG PART:DP-7.0CM-5000T6000-CW

5000MHz to 6000MHz Single-Junction Surface Mount Circulator

REV.	DESCRIPTION	REVISOR	DATE	APPROVED
A	SAME AS REV.2	ZZ.Zhu	2024/5/30	Nick

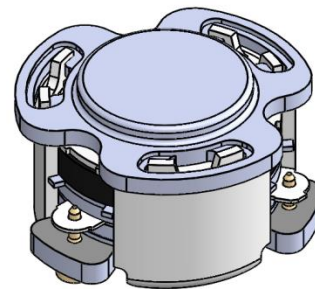

Applications:

- Wireless Infrastructure
- Power Amplifier

Features:

- Operating frequency range: 5000MHz to 6000MHz
- Operating temperature range: -40°C to +85°C
- Storage temperature range: -55°C to +135°C
- Small surface-mount package delivered on T&R
- BeO free & RoHS compliant

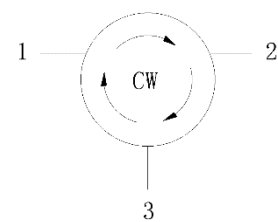

Block Diagram



Electrical Specifications:

ITEM	SPECIFICATION	
Frequency	5000~6000	MHz
Direction	CW	
Impedance	Typ: 50	Ω
Insertion Loss (Max.)	0.75@25±10℃ 0.80@-40~+185℃	dB
Isolation (Min.)	18@25±10℃ 15@-40~+85℃	dB
Return Loss (Min.)	18@25±10℃ 15@-40~+85℃	dB
3rd IMD (Max.)	/	dBc
2nd harmonic	/	dB
3rd harmonic	/	dB
Group delay	/	ns
Out of band resonance	/	
Power FWD/REV/PEAK	20/20/160	W
Input Impedance, Real	/	Ω
Input Impedance, Imaginary	/	Ω
Termination/Attenuator	/	W/dB

Notes:

1. Exposure to maximum rating conditions for extended periods may reduce device reliability. There is no damage to device with only one parameter set at the limit and all other parameters set at or below their nominal value. Exceeding any of the limits listed here may result in permanent damage to the device.
2. Performance is guaranteed under the conditions listed in this table and over the operating temperature range.



Mechanical Specifications:

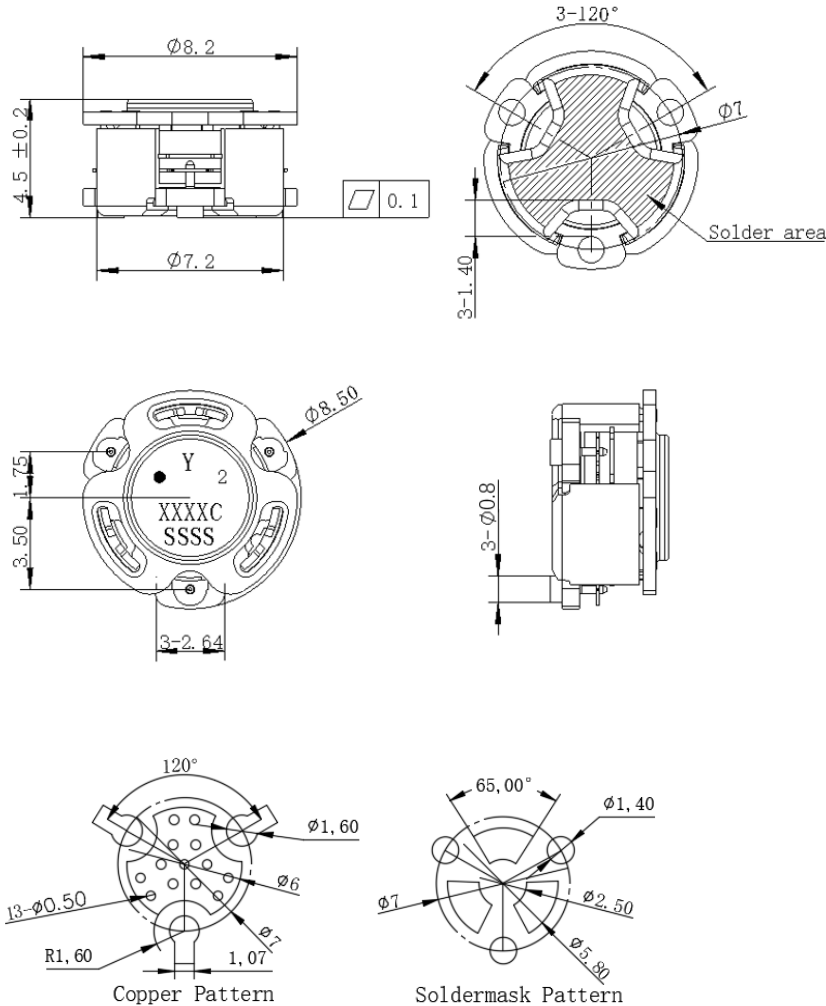

PCB Material: ROGERS R04350B 0.508mm thickness trace width 1.07mm wide

Unit: Millimeters

Notes:

1. The housing and pins are silver-plated.
2. Tolerance ± 0.2 mm unless otherwise specified.
3. Co-planarity Specification: 0.1mm maximum.
4. Part Number, Lot Code, and Port Designation are printed on the top side of device
5. The "Y" show on the label represents the producing year, when printing the producing year, A stands for 2022, B for 2023, C for 2024, and so on (reference DP's file WDPT PD-003).
6. The **XXXXC** on the label represents the last five digits of the Part Number.
7. The SSSS on the label represents the serial number
8. The black dot on the label represents the input port