



DP3048C

ENG PART:DP-27CM-791T821-CCW

791MHz to821MHz Single-Junction Surface Mount Circulator

REV.	DESCRIPTION	REVISOR	DATE	APPROVED
A	Creating datasheet	ZZ.Zhu	2024/3/4	Nick

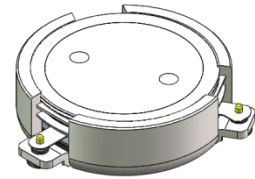

Applications:

- Wireless Infrastructure
- Power Amplifier

Features:

- Operating frequency range:791MHz to 821MHz
- Operating temperature range: -40°C to +125°C
- Storage temperature range: -50°C to +150°C
- BeOfree&RoHS compliant

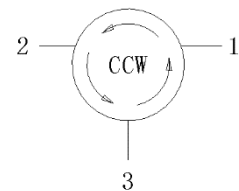

Block Diagram



Electrical Specifications:

ITEM	SPECIFICATION	
Frequency	791~821	MHz
Direction	CCW	
Impedance	Typ: 50	Ω
Insertion Loss (Max.)	0.25@25±10°C 0.30@-40~+125°C	dB
Isolation (Min.)	24@25±10°C 22@-40~+125°C	dB
Return Loss (Min.)	24@25±10°C 22@-40~+125°C	dB
Power FWD/REV/PEAK	250/-/1000	W
IMD (Max.)	-70@2X50W tones, Spacing 5MHz	dBc
Out Band Resonance		
Input Impedance ,real	44~56	Ω
Input Impedance ,imaginary	-7j~+7j	Ω
Termination/Attenuator	/	W/dB

Notes:

1. Exposure to maximum rating conditions for extended periods may reduce device reliability. There is no damage to device with only one parameter set at the limit and all other parameters set at or below their nominal value. Exceeding any of the limits listed here may result in permanent damage to the device.
2. Performance is guaranteed under the conditions listed in this table and over the operating temperature range.



Mechanical Specifications:

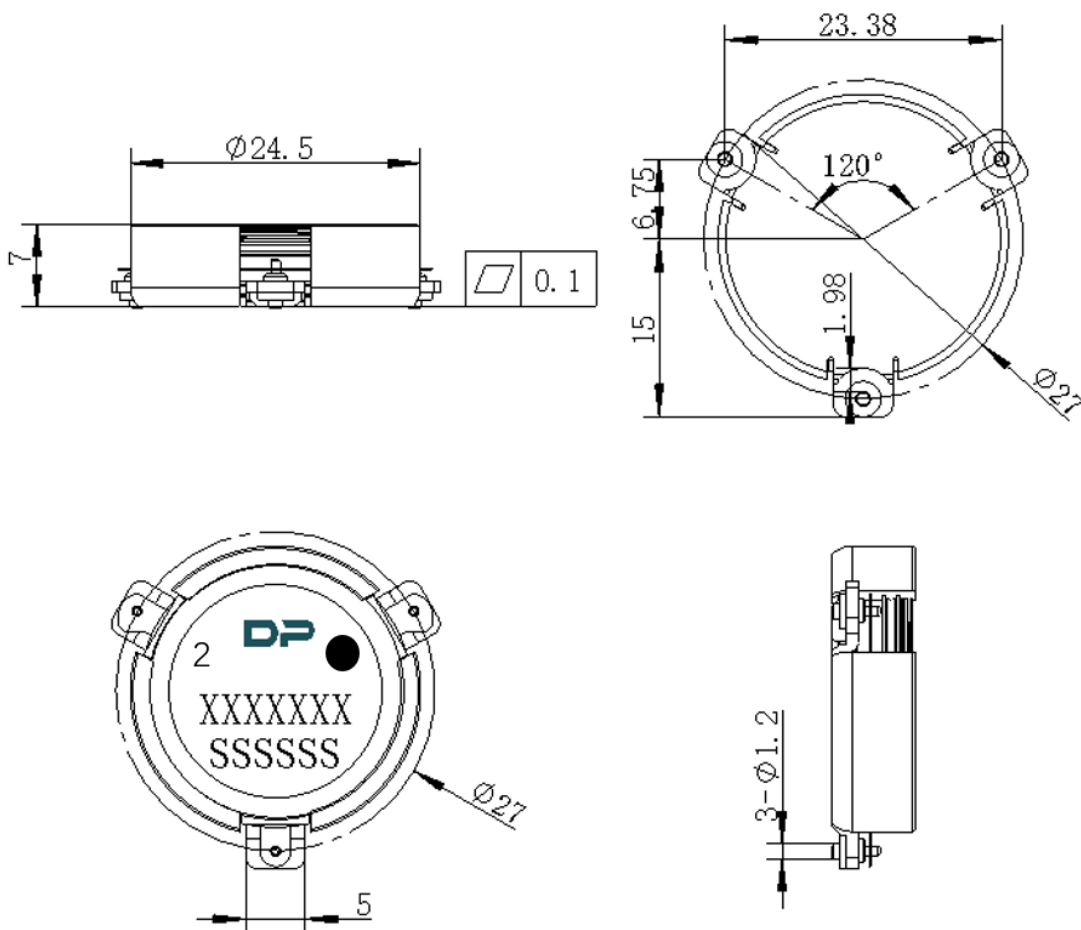

Unit: Millimeters

Notes:

1. The housing and pins are silver-plated.
2. Tolerance ± 0.2 mm unless otherwise specified.
3. Co-planarity Specification: 0.1 mm maximum.
4. Part Number, Lot Code, and Port Designation are printed on the top side of device.
5. The **XXXXXXX** on the label represents the part number
6. The **SSSSSS** on the label represents the serial number
7. The black dot on the label represents the input port