



DP2781C

ENG PART:DP-10.2CM-868T885-CW

868MHz to 885MHz Single-Junction Surface Mount Circulator

REV.	DESCRIPTION	REVISOR	DATE	APPROVED
A	SAME AS REV.1	ZZ.Zhu	2023/8/22	Nick

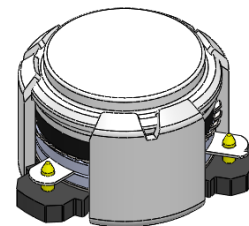

Applications:

- Wireless Infrastructure
- Power Amplifier

Features:

- Operating frequency range: 868MHz to 885MHz
- Operating temperature range: -40°C to +105°C
- Storage temperature range: -65°C to +150°C
- Small surface-mount package delivered on T&R
- BeOfree&RoHS compliant

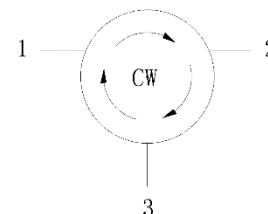

Block Diagram



Electrical Specifications:

ITEM	SPECIFICATION	
Frequency	868~885	MHz
Extend frequency	/	MHz
Direction	CW	
Impedance	Typ: 50	Ω
Insertion Loss (Max.)	0.45@25°C 0.55@-40~+105°C	dB
Isolation (Min.)	20.0@25°C 18.0@-40~+105°C	dB
Return Loss (Min.)	20.0@25°C 18.0@-40~+105°C	dB
3rd IMD (Max.)	-58@2x1W CW tones, 1MHz spacing	dBc
Group delay	/	ns
2nd harmonic suppression	/	dBc
3rd harmonic suppression	/	dBc
Power FWD/REV/PEAK	25/-/160	W
Termination/Attenuator	/	W/dB
Resonance point of out-off-band	/	MHz
Input Impedance ,real	/	Ω
Input Impedance ,imaginary	/	j Ω

Notes:

1. Exposure to maximum rating conditions for extended periods may reduce device reliability. There is no damage to device with only one parameter set at the limit and all other parameters set at or below their nominal value. Exceeding any of the limits listed here may result in permanent damage to the device.
2. Performance is guaranteed under the conditions listed in this table and over the operating temperature range.
3. Performance will not degrade by > 10% (Insertion loss > 20%) with an operating temperature of up to 130 °C.



Mechanical Specifications:

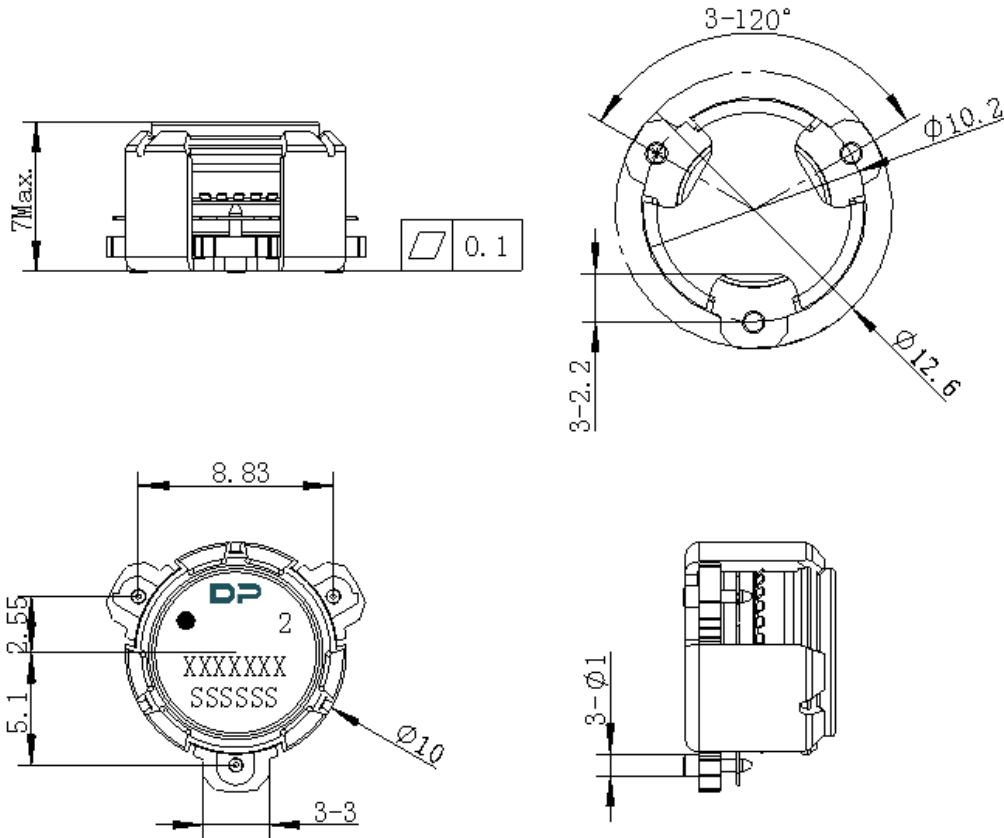

Unit: Millimeters

Notes:

1. The housing and pins are silver-plated.
2. Tolerance $\pm 0.2\text{mm}$ unless otherwise specified.
3. Co-planarity Specification: 0.1mm maximum.
4. Part Number, Lot Code, and Port Designation are printed on the top side of device.
5. The **XXXXXXXX** on the label represents the part number
6. The **SSSSSS** on the label represents the serial number
7. The black dots represent the input port.



Packaging Style:

ITEM	W	A0	B0	C0	K0	D	E	F	F2	P	P0	P2	T
DIM	32	Φ10.4	12.5	4	7.0	Φ1.5	1.75	14.2	28.5	24	4	2	0.5
TOLE	±0.3	±0.2	±0.2	±0.2	±0.2	+0.1	±0.1	±0.15	±0.1	±0.1	±0.1	±0.1	±0.05

